



ramonsoler.

2023

**ramonsoler.**

El arte de fluir



## Catálogo - Lista de precios 2023

Precios recomendados de venta al público en Euros

(IVA no incluido)

Industrias Ramon Soler, S.A se reserva el derecho, por necesidades de diseño y servicio, de modificar, sustituir o eliminar, sin previo aviso, los modelos y elementos descritos en esta publicación. Las fotografías, diseños técnicos y ambientes reproducidos tienen un valor indicativo, por lo que el cliente no podrá acogerse a ellos para posibles reclamaciones.

Siguiendo la normativa REACH (Reglamento (CE) N1907/2006) Reglamento Europeo relativo al Registro, Evaluación, Autorización y Restricción de las sustancias y mezclas químicas, les informamos algunos de nuestros productos pueden contener plomo en concentraciones superiores al 0,1% m/m. El pasado 27 de junio de 2018 el plomo fue añadido a la lista de sustancias candidatas extremadamente preocupantes (SVHC), más concretamente fue incluido como sustancia tóxica para la reproducción humana (categoría 1A).

Todos nuestros productos son para instalar en interior.

## Catalogue - Price List 2023

Retail sales recommended in Euros

(no taxes included)

Industrias Ramon Soler, S.A reserves the right, for design and service needs, to modify, replace or eliminate, without prior notice, the models and elements described in this publication. The pictures, technical designs and environments reproduced have an indicative value, so the client will not be able to avail himself of them for possible claims.

Following the European Regulation on Registration, Evaluation, Authorization and Restriction of Chemicals REACH ((EC) No. 1907/2006), we inform you that some of our products might contain lead in concentrations over 0,1% w/w. Lead metal was included on the Candidate List of Substances of Very High Concern (SVHC) on 27 June 2018, more specifically it was included as Toxic for Reproduction (Category 1A).

All our products are for indoor installation.

## Contacte con nosotros

Contact us

---

Para solicitar información  
for any requests:

[info@rsramonsoler.com](mailto:info@rsramonsoler.com)

Para pedidos / for orders:  
[pedidos@rsramonsoler.com](mailto:pedidos@rsramonsoler.com)  
Tel. +34 933 738 001  
Fax. +34 933 737 858

Horario comercial:  
De lunes a viernes,  
de 7h a 15:00h.

Commercial Timetable:  
Monday to Friday,  
from 7h to 15.00h.

Dirección / Adress:  
Industrias Ramon Soler, S.A.  
Vallespir, 26. Pol. Ind. Font Santa  
08970 Sant Joan Despí (Barcelona). Spain

Flagship Store:  
Vía Augusta, 107  
08006 Barcelona . Spain  
Tfno.: 936 315 38

# Índice

## Index

### Monomando

#### Single lever

Odisea	046
Urban Chic	084
Alexia	102
Tzar	124
Arola	144
Kuatro	154
Kuatro NK	174
Drako	184
New Fly	218
Ypsilon Plus	230
Civic	242
Titanium	252

### Bimando

#### Two handle mixers

Adagio	072
Gaudi	206
Eco	264

### Conjuntos termostáticos

#### Thermostatic shower set

Termotech	276
Blautherm	285

### Blautherm Duchas

#### Shower

Duchas termostáticas	285
Thermostatic single lever	
Duchas monomando	287
Single level	
Baño-ducha monomando	288
Single level bath & shower	
Baño-ducha termostática	291
Thermostatic bath & shower	
Kit blautherm	292

### RS Smart

Termostáticos empotrados de ducha	301
Thermostatic shower sets	

### Hidroterapia

#### Hydrotherapy

Cascada	304
Waterfall	
Rociadores volumétricos	306
Shower head	
Cromoterapia	309
Ultraslim	310
Grandes rociadores empotrados	312
Big concealed showerheads	
Rociadores	315
Showerheads bar	
Barras ducha	322
Slide bar sets	
Teleduchas	329
Handshowers	
Flexibles	332
Conjuntos teleducha	334
Shower sets	

### Accesorios de Baño

#### Bathroom Accessories

#### WC

WC Magnet	349
Conjuntos WC WC sets	350

#### Cocina Kitchen

Pure water	363
Magnet	364
Square	365
Profesional	365
Extraibles	367
Altos	369
Abatible	370
Bajos	370
Clásicos	371

#### Breem·Hoteles Breem·Hotels

Cálculo Hotel	380
Calculation	
Alexia Hotel	384
Drako Hotel	386
New Fly Hotel	387
Grandes Duchas	391
Big showers	
Termostáticas	390
Thermostatic	

#### Colectividades Collectivities

Soltronic	397
Solestop	401
Medical	406

#### Showroom

#### Renove

#### Accesorios Accesories

#### Condiciones generales venta

#### General conditions of sale

## Creaciones Creations



Odisea **46**



Adagio **72**



Urban Chic **84**



Alexia **103**



Tzar **124**



Arola **144**



Kuatro **154**



Kuatro NK **174**



Drako **184**



Gaudi **206**

## Distribución Distribution



Ypsilon Plus **230**



New Fly **218**



Civic **242**



Titanium **252**



Eco **264**

## Blautherm columnas de ducha Blautherm shower columns



Duchas termostáticas  
Thermostatic single lever

**285**



Duchas monomando  
Single level

**287**



Baño ducha monomando  
Single level bath & shower

**288**



Baño-ducha termostática  
Thermostatic bath & shower

**291**



KIT Blautherm  
Single lever concealed

**292**

## Conjuntos empotrados Concealed sets



RS Smart **296**

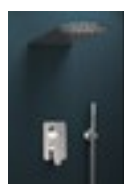

Includidos en cada serie  
Included in each series

**Thermotech**



Thermotech  
276

**Hidroterapia Hidroteraphy**



Volumétricos  
Shower head  
306



Cascada  
Waterfall  
304



Cromoterapia  
309



Ultraslim  
310



Barras ducha  
Slide bar set  
322



Conjuntos ducha  
Shower sets  
334

**Accesorios de baño Bathroom accesories**



Accesorios baño Bathroom accessoires 338



**WC**



Wc Magnet 349



Wc 350

**Cocina Kitchen**



**N**  
Pure Water  
363



Magnet  
364



Square  
365



Professional  
365



Extraibles  
Extensible  
367



Altos  
High  
369



Bajos  
Low  
370



Clasicos  
Classic  
371

**Hoteles BREEAM Hotels**



Alexia Hotel 384



Drako Hotel 386



New Fly Hotel 387



Soltronic 397



Solestop 401



Medical 406

**Colectividades Collectivities**

**Showroom**



Expositores 408



Renove 430



Accesorios Accesories 476

**Índice**

Condiciones  
generales venta  
General  
conditions of sale 506

# 1890 2023

Mas de 130 años de historia que avalan nuestro saber hacer.

More than 130 years of history that guarantee our know-how.

ramonsoler.

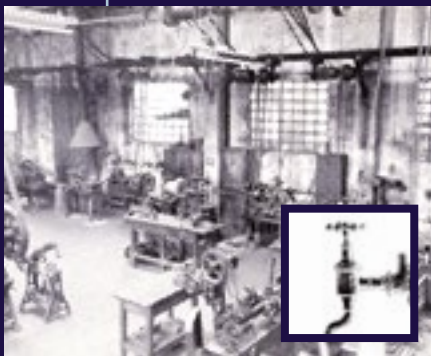

1890



1929

Exposición Internacional  
Barcelona Medalla de oro  
International exhibition  
Barcelone Gold medal



1968

Joya Orla



1987

Primer monomando Solemix  
First single mixer Solemix



1992

Creación nueva fábrica  
New factory creation



1994

Primer Termostático  
Termosol  
First thermostatic  
Termosol



2004

liada Swarovski Mithos



2005

Serie Gaudí con La Cartuja  
de Sevilla  
Gaudí with La Cartuja de  
Sevilla





2009

Arola diseñada por Antonio Arola  
Arola designed by Antonio Arola



2012

S2-S3/C2-C3



2018

Flagship Store Barcelona

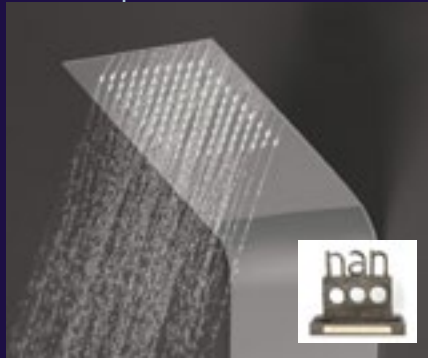

2018

Hidroterapia XI Prize Nan  
Arquitectura y Construcción



2020

Urban Chic



2020

New Fly



2021

Cocina kitchen Magnet



2022

Cocina kitchen Magnet



2022

Urban Chic



2023

Adagio

# Odisea



 Cromo  
Chrome

 Negro mate  
Black matte

 Oro cepillado  
Brushed gold

 Cobre cepillado  
Brushed gold

**N** New



Odisea/brushed gold



# Acabados especiales

Special finishes

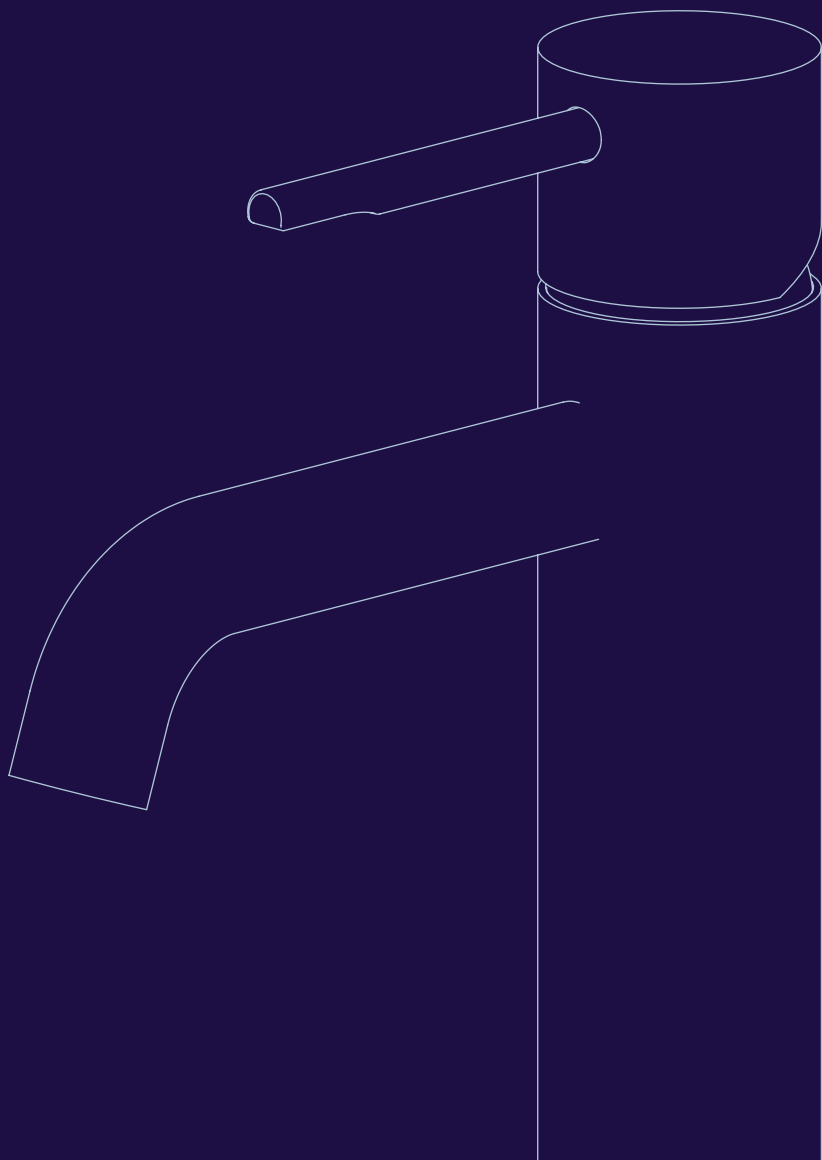

ramonsoler.

Baño Bathroom



Negro mate  
Black matte



Niquel cepillado  
Brushed nickel



Oro cepillado  
Brushed gold



Cobre cepillado  
Brushed copper

Accesorios Accessories



Negro mate  
Black matte



Niquel cepillado  
Brushed nickel



Oro cepillado  
Brushed gold

Cocina Kitchen

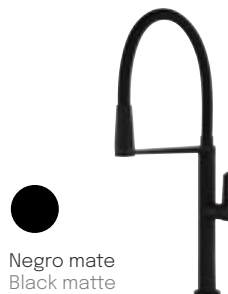

Negro mate  
Black matte



Niquel cepillado  
Brushed nickel

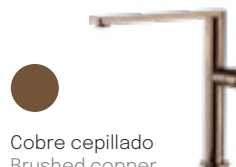

Cobre cepillado  
Brushed copper



Cobre  
Copper































Inox  
Stainless steel

# Acabados PVD

## PVD finishes

Índice de acabados Finishes index







	Lavabo	Lavabo M	Lavabo L	Lavabo XL	Bidé	Lavabo empotrado
	Washbasin mixer	Washbasin mixer M	Washbasin mixer L	Washbasin mixer XL	Bidet mixer	Wall washbasin mixer
Odisea N	 ● ● ● ●		 ● ● ●		 ● ● ●	 ● ● ●
Adagio	 ● ●	 ● ●	 ● ●		 ● ●	 ● ●
Urban Chic	 Cascada Waterfall ● ●	 ● ● ●		 ● ● ●	 ● ● ●	 ● ● ●
Alexia		 ● ● ●	 ●	 ● ● ●	 ● ● ●	 ● ● ●
Tzar		 ● ● ●	 ●	 ● ● ●	 ● ● ●	 ● ● ●
Arola	 ●		 ●		 ●	
Drako		 ●	 ●		 ●	
New Fly	 ●	 ●	 ●	 ●	 ●	 ●

PVD (Physical Vapor Deposition) consiste en un proceso físico, no químico, con una resistencia similar al tratamiento de cromado. Se caracterizan por una excepcional dureza superficial, resistencia al desgaste y a la abrasión, a la corrosión, a disolventes y detergentes, y tienen un impacto ecológico irrelevante.

PVD (Physical Vapor Deposition) consists of a physical, non-chemical process with a resistance similar to chrome plating. They are characterized by exceptional surface hardness, resistance to wear and abrasion, corrosion, solvents and detergents, and have an irrelevant ecological impact.

Lavabo columna	Baño-ducha columna	Ducha-monomando empotrado	Baño-ducha termostático	Ducha termostática	Termostático empotrado	Columna ducha
Free standing washbasin	Free standing bath shower	Single lever concealed	Thermostatic bath-showe	Thermostatic shower	Thermostatic concealed	Shower column

# Baño Bathroom

Columnas	Termostático	Monomando	Termostático	Monomando	Termostático	Monomando
Columns	Thermostatic	Mixer	Thermostatic	Mixer	Thermostatic	Mixer
<b>Blautherm</b>						































	Rs Smart		WC			
						
	<b>N</b> ● ● ●		● ● ●	● ● ●		











# Cocina Kitchen

	Pure water		Cocinas Magnet	90°	Altas caño curvo	Altas caño recto
						
	<b>N</b> ● ●		● ●	●	● ●	● ●
						
			● ● ●	● ●		

## Hidroterapia Hidrotherapy

Rociadores murales							
							
● ●	● ●	● ●	● ● ●	● ● ●	●	●	
Rociadores techo							
							
● ●	● ●	● ● ●	● ● ●	ABS ●	ABS ●	∅ 550 ● ●	50x50 ● ●
Barras de ducha		Codos de agua		Sifones	Click Clack	Llaves de paso	
							
● ● ●	● ● ●	● ● ●	● ● ●	● ● ●	● ● ●	● ● ●	
							
● ● ●	● ● ●	● ● ●	● ● ●				
Sets		Caños bañera					
							
● ● ●	● ● ●	● ● ●	● ● ●				

## Accesorios de baño Bath accessories

Toallero estante	Toallero L	Toallero XL	Toallero	Colgador	Porta Papel	Jabonera	Escobillero
Towel rack shelf	Towel rach Large	Towel rach XL	Towel rack	Hook	Paperholder	Soap dish	Toilet brush
							
● ● ●	N ● ● ●	● ● ●	● ● ●	● ● ●	● ● ●	● ● ●	● ● ●

# Compromiso Ramon Soler

## Ramon Soler Commitment

Desde hace décadas Ramon Soler es una empresa con una clara vocación de servicio no solamente hacia sus empleados, clientes y usuarios, si no que va más allá, hacia un compromiso con la sociedad y el medioambiente.

For decades Ramon Soler is a company with a clear vocation for service not only towards its staff, customers and users, but it goes further, towards a commitment to society and the environment.







Transformación cultural  
Cultural transformation

---

Nueva identidad  
New identity

---

Economía circular  
Circular economy

---

Certificaciones para edificios  
Building certifications

---

Innovación  
Innovation

---

Diseño inteligente  
I-design

---

Calidad  
Quality



Transformación cultural  
Cultural transformation



Ramon Soler está inmerso en un proceso de Transformación Cultural que abarca todo aquello que la Empresa realiza y sus consecuencias en las personas, la sociedad y el medioambiente.

### **Ejes principales:**

- Generación de un propósito de la empresa consensuado con los empleados que impulse y alinee internamente todas las voluntades.
- Especial cuidado en las políticas de RSC (Responsabilidad Social Corporativa). Protocolos internos, políticas de igualdad de género, conciliación laboral, compliance penal y ayudas sociales, entre otros.
- Generar un modelo de Economía Circular que nos lleve a maximizar constantemente el cuidado del planeta y nos acerque a un modelo plenamente ecosostenible.

Ramon Soler is currently experiencing a Cultural Transformation process that encompasses all that the Company does, as well as the consequences thereof on people, society and the environment.

### **Main focus:**

- Generating a business purpose in agreement with its employees that internally promotes and aligns the wills of all parties.
- Special care in the application of Corporate Social Responsibility (CSR) policies. Internal protocols as well as gender equality, work-life balance, criminal compliance and social aid policies, among others.
- Generation of a Circular Economy model that allows us to permanently protect the planet, bringing us closer to a completely eco-sustainable model.

# Nueva identidad

## New identity



Hemos renovado nuestra imagen a través de una transformación profunda en un proceso de retorno a nuestra esencia y su proyección hacia un nuevo futuro.

We have renovated our image by means of a profound transformation in a process of returning to our essence and its projection into a new future.

## LOGOTIPO LOGO

---

# ramonsoler.

## POWER STATEMENT

---

# El arte de fluir

## IMPLANTACIÓN 360° 360° IMPLEMENTATION

---

Catálogos | Papelería | Packaging | Producto | Exposición

Catalogues | Stationery | Packaging | Product | Display



# Economía circular

## Circular economy



El modelo de Economía Circular está inspirado en la naturaleza y sus procesos. Tiene la plena capacidad de crear ecosistemas sostenibles gracias a la especialización de cada función: materiales, procesos, sistemas y personas.

Proceso de mejora continua, con el cual, todas las personas en Ramon Soler están colectiva y personalmente implicadas.

En Ramon Soler trabajamos desde hace tiempo para mejorar nuestra eficiencia industrial en temas como:

- **Ampliar la vida de nuestros productos** ofreciendo una alta calidad, diseños atractivos y sistemas fáciles de reparar.

---

- Diseños pensados para **optimizar la utilización de materiales**, la eficiencia en procesos, los volúmenes de transporte y el reciclaje de materiales, entre otros.

---

- Nuevo packaging con **materiales sostenibles y reciclados hasta un 70%**, eliminando plásticos y utilizando exclusivamente materiales de celulosa.

---

- **Optimización del consumo de agua y electricidad** en todas nuestras instalaciones, minimizando el consumo y consiguiendo hasta la fecha la autogeneración de energía cubriendo actualmente un 30% de nuestras necesidades a través de placas solares.

The Circular Economy model is inspired by nature and its processes. It has full capacity to create sustainable ecosystems thanks to the specialisation of each function: materials, processes, systems and people.

A continuous improvement process in which all the employees of Ramon Soler are collectively and personally engaged.

At Ramon Soler, we have been working for some time on improving our industrial efficiency in areas such as:

- **Extending the life of our products**, providing high quality, attractive designs and system that are easy to repair.

---

- Designs that **optimise the use of materials**, the efficiency of processes, transport volumes and recycling of materials, among others.

---

- New packaging with sustainable, **70% recycled materials**, eliminating plastics and using only cellulose materials.

---

- **Optimisation of water and electricity** consumption throughout our facilities, reducing consumption and using power generated on our own premises to cover 30% of our needs through the use of solar panels.



# Certificaciones para la edificación

## Building certifications



Ramon Soler está absolutamente implicado en los normativas y sellos que certifican nuestra calidad y son imprescindibles para la eficiencia en la construcción:

- Nuevas referencias con sello BREEAM, LEED y VERDE para edificios sostenibles.
- Biblioteca de modelos BIM para la eficiencia en la construcción de edificios.
- Normativas AENOR, NF, DVGW, NOM, AQUABELA,...
- Miembro del Comité de la Norma Francesa en grifería sanitaria.
- Socio fundador del programa FDES para el cálculo de la huella de carbono.
- Auditoría externa ECOVADIS.

Ramon Soler is fully involved in complying with the standards and certifications that demonstrate our quality and are essential for efficiency in building:

- New references with the BREEAM, LEED and VERDE sustainable building certifications.
- BIM library to guarantee efficiency in the construction of buildings.
- AENOR, NF, DVGW, NOM and BELGAQUA certifications.
- Member of the French Sanitary Tapware Regulation Committee.
- Founder member of the FDES carbon footprint calculation programme.
- External audit by ECOVADIS.

## ecovadis

Para poder medir nuestro compromiso y nuestra realidad en aspectos de Ecosostenibilidad, RSC y Compromiso social nos hemos sometido a una auditoría externa a través de ECOVADIS, consiguiendo la medalla de Bronce en 2022 y desde la Dirección General a través de nuestro comité interno de Sostenibilidad, hemos asumido el compromiso de conseguir la medalla de Plata para este 2023.

To measure our commitment and our current situation in matters related to Eco-sustainability, CSR and Social Commitment, we have undergone an external audit by ECOVADIS and were awarded the Bronze Medal in 2022. Through our internal Sustainability committee, Directorate-General has assumed the undertaking to win the Silver Medal in 2023.



Nuestros productos están preparados para el cumplimiento de las certificaciones ambientales de edificio (BREEAM, LEED, VERDE,...) donde el buen uso del agua es una de las líneas fundamentales de actuación, aportando valor sostenible de carácter medioambiental en las edificaciones.

Nuestras principales líneas de productos están adaptadas a dichas exigencias y formamos parte del programa BREEAMers, colaborando activamente en eventos y formaciones, como empresa medioambiental y socialmente responsable.

Our products are prepared for compliance with building environmental certifications (BREEAM, LEED, GREEN,...) where the proper use of water is one of the fundamental lines of action, providing sustainable environmental value in buildings.

Our main product lines are adapted to the BREEAM requirements. We are also members of the BREEAMers Programme and actively cooperate in events and training sessions, as a socially and environmentally responsible company.



Innovación  
Innovation

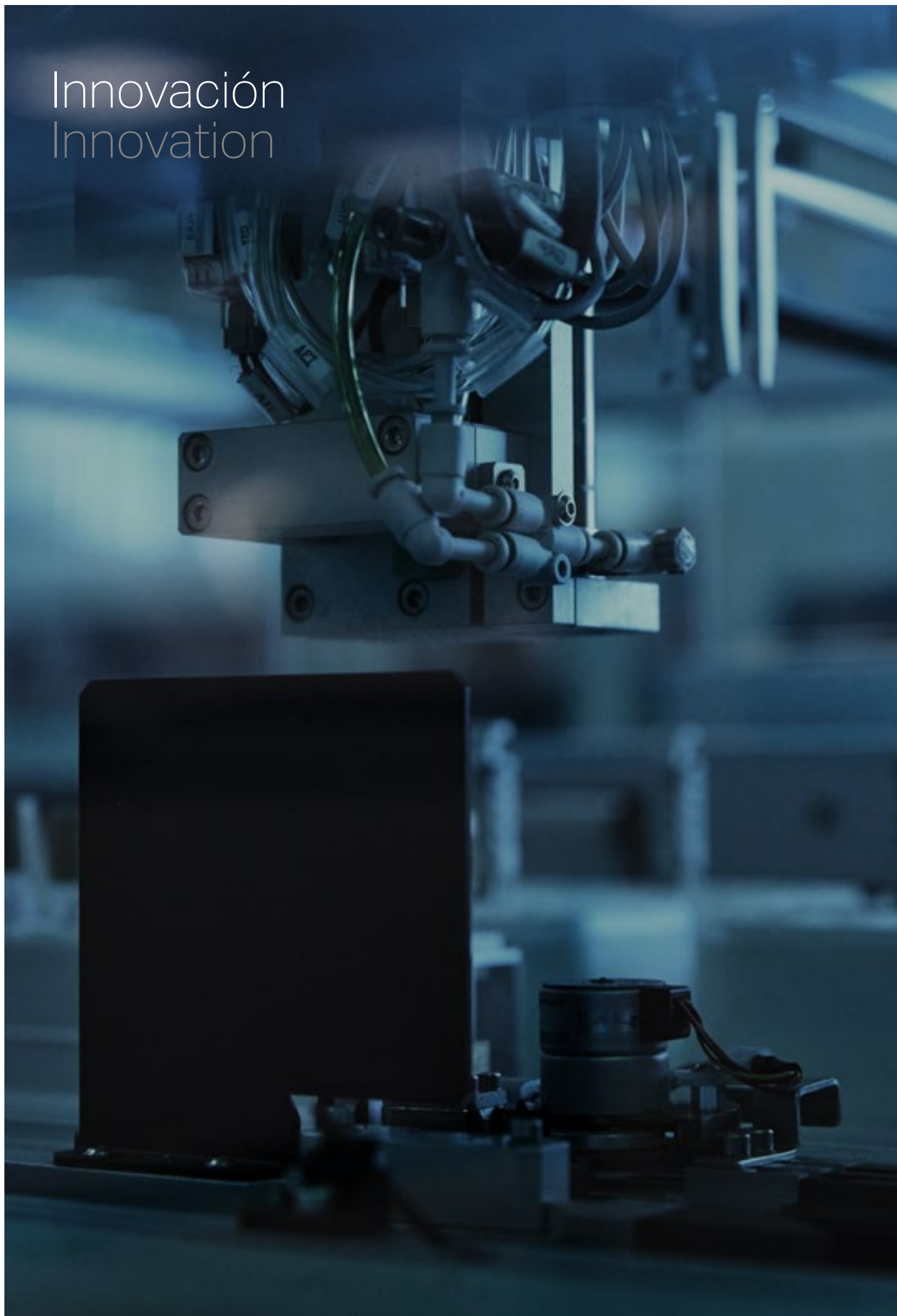

Nuestro firme compromiso con la innovación, a través de nuestro programa Ramon Soler **Innovtech** y **Programa de Mejora Preventiva**, generando más de 20 patentes y modelos de utilidad generados en los últimos cuatro años, a destacar:

Our firm's unwavering commitment to innovation is patent in the Ramon Soler **Innovtech and Prevention Improvement Programme**, which has generated more than 20 patents and utility models during the past four years, including:



Sistema de fijación  
A fastening system



Pure Water



Sistema Tourbillon  
A tourbillon system



Cocinas Magnet  
Magnet kitchens



Ánodo de sacrificio  
Sacrificial anode



WC Magnet



Regulación Temporizados  
Adjustable timed flow

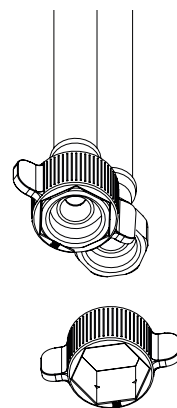

Palometas pasantes  
Threaded wing nuts

# N Mejora en los sistemas de fijación: Improvement in fixing systems:

La mejora del sistema beneficia sobre todo al instalador, ya que se reduce notablemente el tiempo de instalación al igual que la simplifica ya que se evitan las herramientas para instalar el grifo. The improvement of the system benefits the installer above all, since the installation time is significantly reduced as well as simplifies it, as any tool is necessary to install the mixer.

## Ahorro en tiempo y seguridad de instalación Time saving and installation safety

**Sistema de herradura FAST**  
FAST anchorage system



**Aplicación general en nuestras series**  
Nueva herradura sobremoldeada (patentada) para sistema de fijación M8.  
**General application in our series**  
New overmolded anchorage (patented) for M8 fastening system.



**01**

Herradura sobremoldeada patentada  
Patented overmolded anchorage.

**02**

Enroscamos y la herradura se sostiene en la rosca.  
We screw and the anchorage is held on the thread.

**03**

Apretamos el tornillo para una buena fijación.  
We tighten the screw for a good fixation.

**04**

Ánodo de sacrificio en las conexiones flexibles.  
Sacrificial anode are located on flexible connections.

**Sistema de fijación TOOL FREE**  
**TOOL FREE fixing system.**



**Sistema de fijación con rosca M32**

- Conexiones flexibles y junta cuerpo preinstaladas
- Reparte la fuerza de sujeción en 360°
- Ánodo de sacrificio en las conexiones flexibles

**Fixing system with M32 thread.**

- Pre-installed body gasket and flexible connections.
- Distributes the clamping force in 360°.
- Sacrificial anode on flexible connections.



<p><b>01</b></p>	<p><b>02</b></p>	<p><b>03</b></p>	
<p>Enroscamos tubo M32 a la base del grifo.                  We screw the M32 tube to the base of the tap.</p>	<p>Lo instalamos en el lavabo.                  Mantiene la estabilidad en 360°.                  We install it in the basin.                  Maintains its stability in 360°.</p>	<p>Apretamos la tuerca manualmente para una buena fijación (opcional apriete con llave).                  We tighten the nut manually for a good fixation (optional tightening with a wrench).</p>	

**Palometa pasante: aplicación general**

**Fixing brackets: general application through**

<p><b>01</b></p>	<p><b>02</b></p>	<p><b>03</b></p>	
<p>Introducimos la palomita en el flexible.                  We introduce the fixing bracket in the flexible.</p>	<p>Enroscamos el flexible en la llave de paso.                  We screw the flexible into the stopcock.</p>	<p>Apretar manualmente para conseguir una buena fijación.                  Hand tighten to get a good fixation.</p>	

# Pure Water

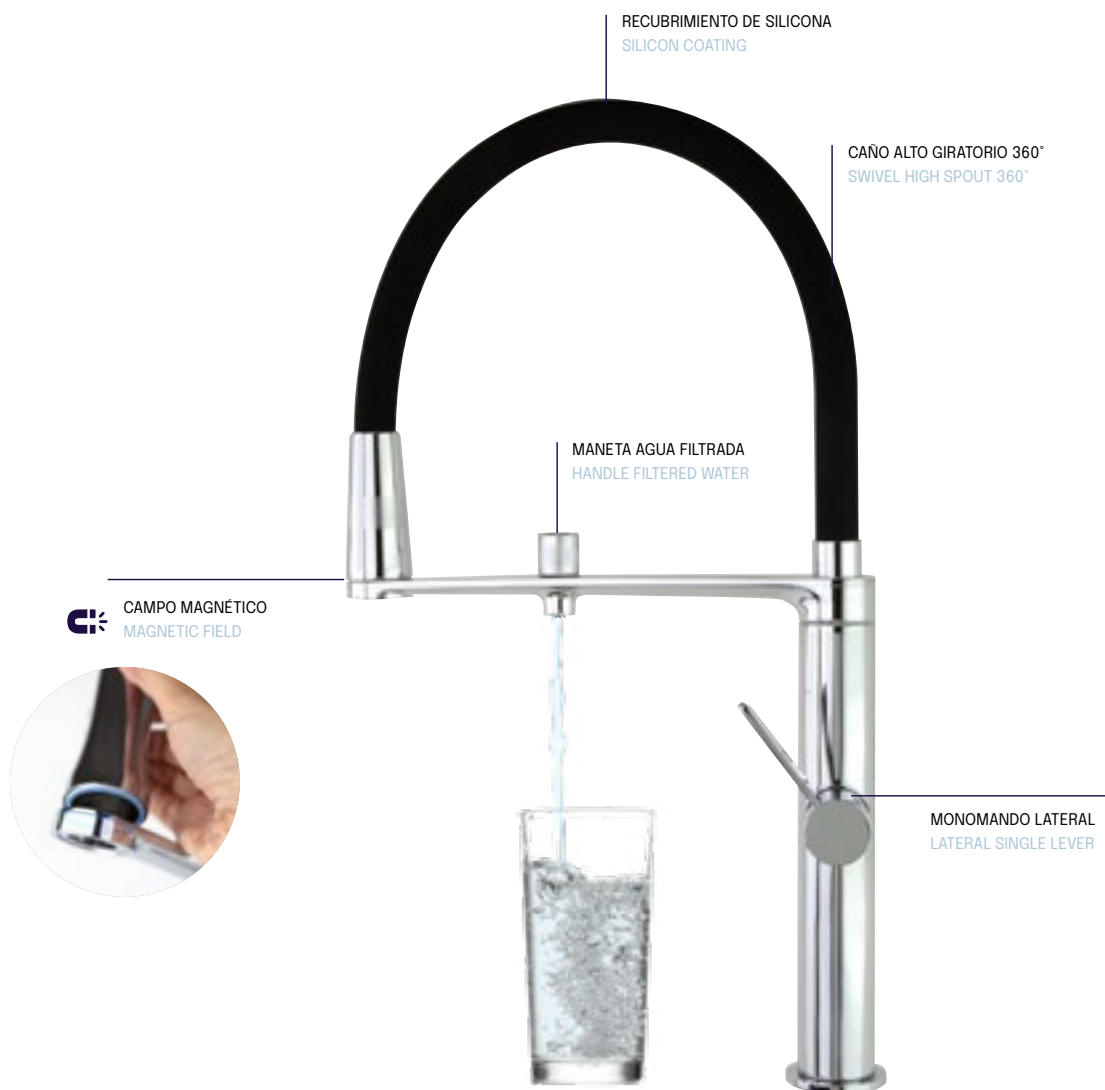

**N** New





Cocinas Magnet  
Magnet Kitchen



RECUBRIMIENTO DE SILICONA

SILICON COATING

CAÑO ALTO GIRATORIO 360°

SWIVEL HIGH SPOUT 360°

DUCHITA EXTRAÍBLE

REMOVABLE

MONOMANDO LATERAL

LATERAL SINGLE LEVER

Innovador sistema de imanes de neodimio que permite al caño volver a su posición inicial de forma suave gracias a la superficie de teflón.

Innovative neodymium magnet system that allows the spout to return to its initial position smoothly thanks to the Teflon surface.



## Sistema tourbillon Tourbillon system

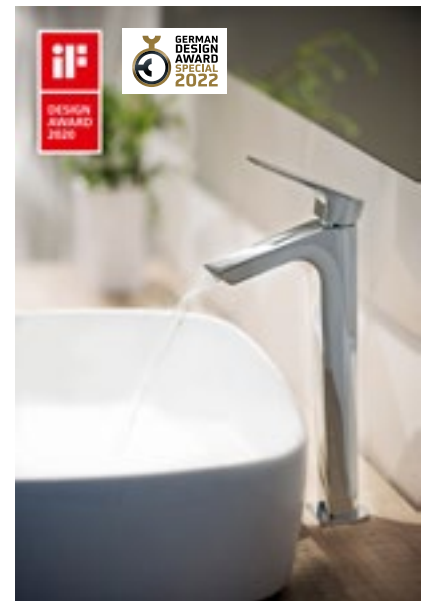

Ramon Soler ha creado y patentado un circuito de agua único y excepcional que controla la fuerza y tensión del agua, para entregarla de forma clara, silenciosa y amable. Como salida de un manantial.

El agua pasa a través de un cartucho standard donde se controla su temperatura y su caudal, es enviada hacia la parte inferior del grifo, donde choca contra el fondo y pierde su bravura, para remontar en un circuito en espiral. Desde allí, es reconducida hacia la caída final donde se libera.

Ramon Soler has created and patented a unique and exceptional water circuit that controls the force and tension of the water, to deliver it in a clear, quiet and friendly way. Like a spring outlet.

The water goes through a standard cartridge where its temperature and flow are controlled, it is sent to the bottom of the tap, where it collides with the bottom and loses its bravery, to go up in a spiral circuit. From there, it is redirected towards the final fall where it is released.

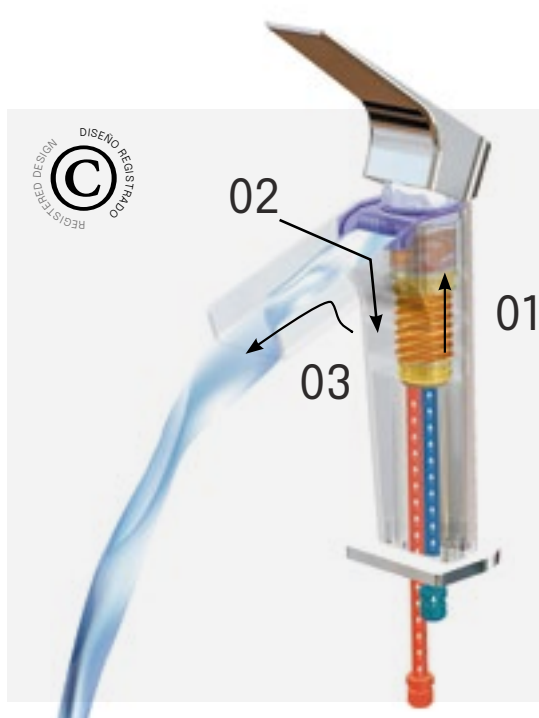

- 01** Cartucho bajo consumo, donde se controla la temperatura del agua y su caudal.  
Low flow cartridge, where it controls the temperature and its flow..
- 02** El agua es enviada hacia la parte inferior del grifo, donde choca contra el fondo y pierde su fuerza.  
Sent towards the bottom of the faucet, where it crosses against the fund and loses its strength.
- 03** Remonta en un circuito espiral donde pierde energía. Para finalizar en una caída en cascada.  
Comes back in a spiral circuit where it loses energy. to finish in a cascade fall.



## RS Smart

### Rs Smart

#### La ducha inteligente

RS Smart es un empotrado termostático de 2 y 3 vías inteligente, capaz de funcionar al mismo tiempo con diferentes salidas de agua y con regulación de caudal individual para cada salida de agua, de esta manera, RS Smart se adapta a las necesidades del usuario en cada momento.

Con RS Smart se consigue una ducha perfecta: selección de temperatura, selección de la salida de agua y selección de intensidad del agua mediante el caudal, todo ello mediante unos botones con doble función creados en Ramon Soler.

El diseño minimalista permite combinar RS Smart con toda la gama de productos de Ramon Soler, especialmente los de hidroterapia con grandes rociadores y también permite ahorrar espacio en el baño. Se presenta en los acabados cromo y negro mate y PVD de oro cepillado, níquel cepillado.

#### The intelligent shower

RS Smart is an intelligent 2 ways and 3 ways concealed thermostatic mixer, capable of operating at the same time with different water outlets and with individual flow regulation for each water outlet. In this way, RS Smart adapts to the needs of the user in every moment.

RS Smart is the perfect shower: temperature selection, water outlet selection and water intensity selection through the flow rate, all through dual-function buttons created by Ramon Soler. The minimalist design allows RS Smart to be combined with the entire range of Ramon Soler products, especially those for hydrotherapy with large shower heads, and also saves space in the bathroom. It comes in chrome and matt black finishings and PVD finishings in brushed gold & brushed nickel.

#### Ventajas RS Smart Advantages of RS Smart

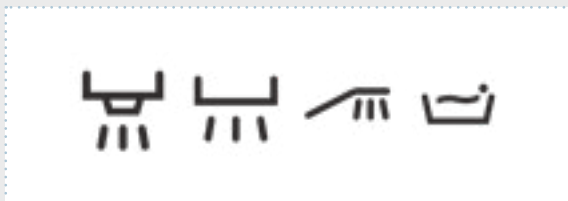

Símbolos para diferentes vías intercambiables.  
Symbols for different water outlets provided in each item.

#### Control inteligente mediante: Intelligent control through:



- Botones de doble función: Bóton pulsador para abrir y cerrar la salida de agua y giratorio para regulación de caudal.
- Dual function buttons: Push button to open and close the water outlet and rotary button to regulate the flow.
- Volante para la regulación de la temperatura.
- Handle for temperature's regulation.
- Se puede seleccionar varias salidas de aguas simultáneas.
- Simultaneous water outlets' selection at the same time.

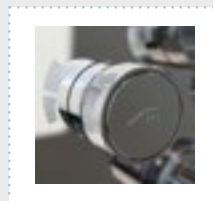

Diseño de los botones con estriado especial ergonómico.  
Ergonomic button through its special design.

RS Smart

Rs Smart



Box completamente estanco y evita filtraciones de agua en el interior de la pared. Puede ser instalada en cualquier tipo de pared, por ejemplo, pladur o standard.

Box completely watertight and prevents water leaks inside the wall. It can be installed on any type of wall, for example plasterboard or standard.

Fácil instalación mediante box con profundidad mínima de 72 mm y ahorro de espacio en el baño mediante placa metálica superslim de espesor 2mm y dimensión del volante máxima de 50 mm.

Easy installation by means of a box with a minimum depth of 72 mm and saving space in the bathroom by means of a super slim metal plate with a thickness of 2 mm and a maximum dimension of the handle of 50 mm.

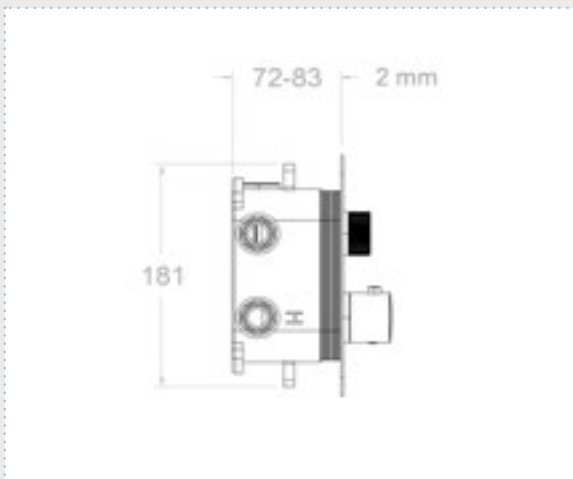

**Cartucho termostático de alta precisión.**

High precision thermostatic cartridge.

**Fácil mantenimiento: permite el cambio del cartucho o de los botones pulsadores sin tener que desinstalar el grifo.**

Easy maintenance: allows the change of the cartridge or the push buttons without having to uninstall the mixer.



Oro cepillado (PVD)  
Brushed gold (PVD)



Negro mate  
Black matte



Niquel cepillado  
Brushed nickel



**WC Magnet**  
WC Magnet

**¡No más fugas!**

Ramon Soler ha creado y patentado una doble válvula de seguridad para las duchitas WC. Después del uso, cuando volvemos a dejar la duchita en el soporte es muy común olvidarnos de cerrar la maneta. El agua va ejerciendo presión durante horas o incluso días, y entonces es cuando existe un grave peligro de fuga de agua e inundación. Por eso proponemos una práctica e inteligente innovación, incorporando una doble válvula de seguridad en el cuerpo del monomando, que se cierra cuando la duchita se coloca en su soporte. Un sistema de imanes ayuda a que el cierre del pasode agua sea perfecto.

**No more leaks!**

Ramon Soler has created and patented a double safety valve for WC showers. After use, when we put the shower back on the holder it is very common to forget to close the handle. The water exerts pressure for hours or even days, and then there is a serious danger of water leakage and flooding. That is why we propose a practical and intelligent innovation, incorporating a double safety valve in the body of the mixer, which closes when the shower is placed on its support. A system of magnets helps to close the water passage perfectly.



VER VIDEO  
WATCH VIDEO

**01** Abierto  
Full open

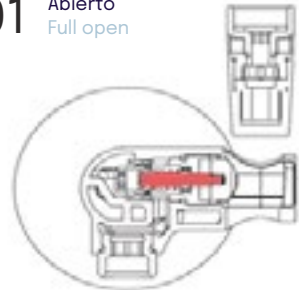

**02** Primer contacto  
First contact

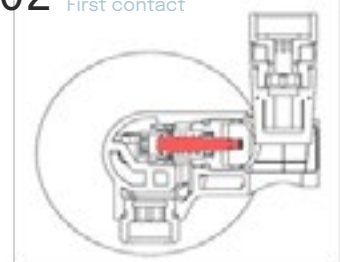

**03** Cerrado  
Fully closed

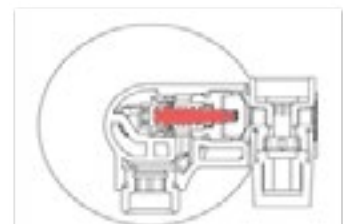

Solestop  
Solestop



Regular el tiempo de cierre es posible

QUICK SET-UP! Sin desmontar la grifería y con nada más que un simple destornillador, podemos regular la posición de la aguja hidráulica que nos permitirá ajustar la temporización independientemente de las condiciones de suministro.

Lower the closing time is possible

Without disassembling the faucet and with a simple screwdriver, we can control the position of the hydraulic needle that will allow us to adjust the timing regardless the flow conditions.

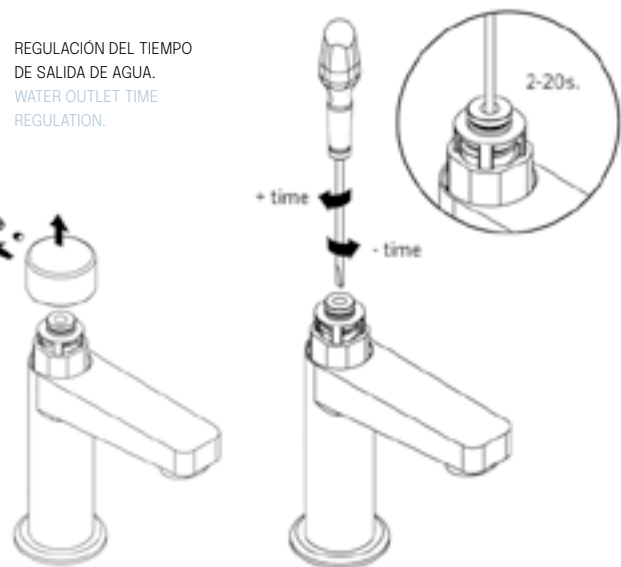

4 Posiciones para generar diferentes caudales

Nuestra grifería a través de la posición de la capsula se puede regular el caudal en 4 posiciones, generando unos mayores niveles de ahorro de agua.

4 Positions to control different flows

Through the capsule position our taps can control the flow in 4 positions, giving higher water level savings.

Posiciones  
Positions

- 1
- 2
- 3
- 4

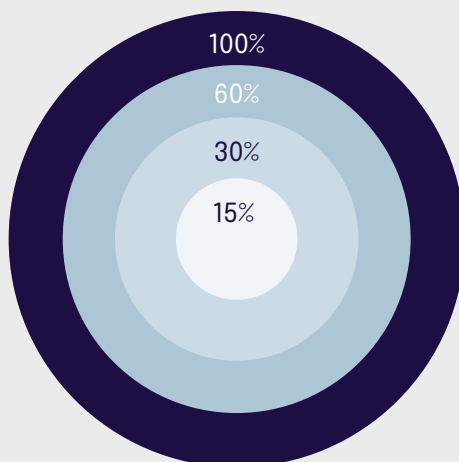

Regulación del caudal de agua.  
Regulation of water flow.

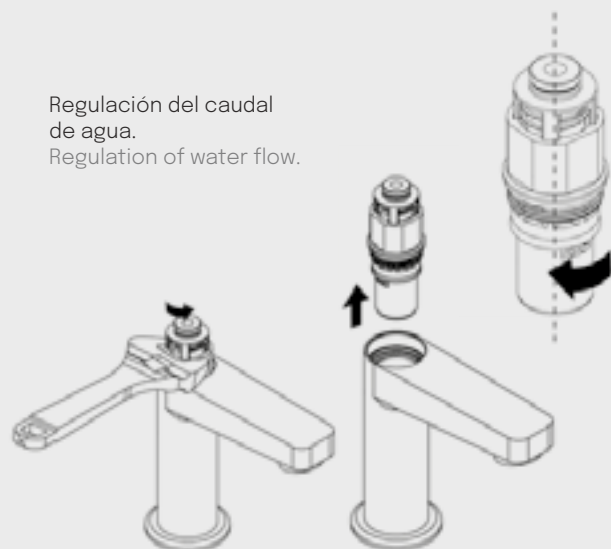



Diseño inteligente  
I - Design

Ramon Soler mixers have multiple systems and devices that affect the user's savings, comfort, health and safety:

Las griferías de Ramon Soler disponen de múltiples sistemas y dispositivos que afectan al ahorro, confort, salud y la seguridad del usuario:

**ramonsoler.**



# Salud Health

## Anti-legionela

Anti-legionela



Siguiendo los reglamentos y las normativas, disponemos de diversos sistemas que evitan la proliferación de la legionela. Nuestros grifos están diseñados con materiales resistentes a los tratamientos con altas concentraciones de cloro, así como a las altas temperaturas necesarias para realizar el choque térmico previsto por la ley (RD 865/2003).

In accordance to international regulations, we have various features which help to eradicate this virus in hydraulic systems. Our tapware incorporates mechanisms which are chlorine resistant and can resist thermal changes as per Spanish Royal Decree (865/2003.)

## Exigencias sanitarias

Sanitary regulations



Nuestras griferías superan las exigentes normativas sanitarias (ACS Francia y KTW Alemania), que garantizan que los materiales en contacto con el agua no suponen ningún riesgo para la salud.

Our tapware is up to the highest standards and complies with Sanitary Regulations (DFWG Germany and NF France) which guarantee the customers piece of mind.

## Protección acústica

Noise protection



Nuestra grifería dispone de diferentes filtros acústicos tanto en las entradas de agua de los grifos como en el interior de sus mecanismos de regulación, optimizando la protección acústica.

Our tapware has acoustic filters both in water connections as well in the mixing cartridges optimizing noise protection.

## Termostop

Termostop



Las griferías termostáticas disponen de un sistema limitador de temperatura, que indica al usuario el límite de temperatura de uso eficiente de 38°C a 42°C. Este sistema limita, mediante un tope de giro del volante la temperatura del agua caliente, pudiendo sobrepasarlo con solo pulsar un botón.

This system avoids the risk of burns and the excessive consumption of hot water. It permits to limit the maximum temperature lock lever through the lever stroke in mixer taps.

# Seguridad Security

## Wc magnet

Wc magnet



Sistema de doble seguridad ante el peligro de inundación. Un magneto crea un cierre perfecto.

Double security system before the danger of flooding. The magnet makes a perfect closure.

## Hotblock

Hotblock system



Nuestro termostático dispone de un sistema que bloquea automáticamente la salida a alta temperatura, lo que podría provocar quemaduras al usuario.

Automatic blockage system which limits the amount of water exiting at a high temperature and saving the user serious burns.

## Cooltouch

Cooltouch system



La grifería termostática permanece siempre templada al tacto, para evitar el riesgo de quemaduras.

Our thermostatic mixers always remain warm to the touch in order to avoid any risk of burns.

# Ahorro Saving

## Ahorro de agua C2/S2

Water saving C2/S2



Nuestros monomandos incorporan un tope intermedio en el recorrido vertical de la palanca. Proporcionando un caudal con un ahorro del 50% de agua.

Nuestro termostático dispone de un sistema que bloquea automáticamente la salida a alta temperatura, lo que podría provocar quemaduras al usuario.

Our single lever basin taps have a double position which limits the water flow on opening the tap. A 50% saving is undertaken, whilst if one wants full flow one only has to open the handle to its maximum. Automatic blockage system which limits the amount of water exiting at a high temperature and saving the user serious burns.

## Ahorro Saving

### Apertura en frío y ahorro de agua C3/S3 Cold opening and water saving C3/S3



Sistema de ahorro de agua y energía, una combinación eficiente que incorpora sistemas de apertura central en frío y tope intermedio (apertura escalonada o en dos fases). Normativa NF de Francia para el ahorro de agua y energía.

This feature enables us to totally open the tap from a cold water start from the central position of the handle. NF regulations in France.

### Limitador de caudal Water limiting



Nuestros monomandos incorporan un tope intermedio en el recorrido vertical de la palanca. Proporcionando un caudal con un ahorro del 50% de agua. Normativa NF de Francia para el ahorro de agua.

Our single lever basin taps have a double position which limits the water flow on opening the tap. A 50% saving is undertaken, whilst if one wants full flow one only has to open the handle to its maximum. NF regulations in France.

### Oxigenación Oxygenation



Nuestros grifos disponen de un sistema de aireación del agua, lo que supone un considerable ahorro en su consumo, al tiempo que garantiza un uso más confortable, evitando salpicaduras. Mezclar aire y agua permite un ahorro hídrico de un 30% y con un mayor confort.

Our tapware includes a special aeration system which saves water as well as giving more comfortable use. It avoids unnecessary splashing saving up to 30% of flow with great comfort.

### Limitador de caudal Water limiting



Nuestros limitadores permiten determinar qué caudal máximo se desea, reduciendo el consumo de agua y manteniendo el confort de uso. La limitación standard son 3,7 l/m en lavabos y 8 l/m para duchas.

Our water limiting systems can regulate the maximum flow required, reducing water usage and maintaining acceptable levels of comfort. The standard limit is 3.7l/min in basins and 8l/min in showers.

## Confort Comfort

### Anodo de sacrificio Sacrificial anode



Protegemos de la corrosión las superficies de la grifería con un ánodo de sacrificio de zinc-magnesio el cual se coloca en todas nuestras series, tanto en los anclajes verticales como en los murales, asimismo nuestras manetas están también protegidas. Este sistema patentado por Ramon Soler triplica la vida de nuestros recubrimientos por corrosión externa.

In Ramon Soler we protect the surfaces of the faucet from corrosion with a zinc-magnesium sacrificial anode which is placed in all our series, both in vertical anchors and murals, our handles are also protected. This system patented by Ramon Soler triples the life of our external corrosion coatings.

### Tourbillon Tourbillon



Un circuito de agua único y excepcional que controla la fuerza y tensión del agua.

A unique and exceptional water circuit that controls the strength and tension of the water.

### Sensibilidad Sensibility



Nuestros cartuchos permiten regular cómodamente la temperatura, la mezcla de agua progresivamente, sin cambios bruscos de temperatura. Además, nuestros cartuchos termostáticos reaccionan en menos de un segundo a variaciones de temperatura y caudal manteniendo la temperatura solicitada.

Our single lever and thermostatic cartridges allow us to comfortably regulate the desired temperature.

### Anti-cal Anti-limestone



Nuestros rociadores cuentan con boquillas de silicona flexibles las cuales la cal y las impurezas se desprenden fácilmente, incluso frotando con los dedos. Boquillas de máxima calidad resistentes al desgaste, con lo que consigues que el rociador se conserve mejor y que su funcionamiento sea 100% fiable.

Our hand and headshowers which have flexible silicon outlet tubes filter impurities easily. Ramon Soler uses tubing of the highest quality, which means longer lasting components. A complete maintenance cycle also reduces technical problems.

### Durabilidad Durability



Nuestra grifería destaca por su gran resistencia ya que todos sus componentes externos con desgaste, son metálicos lo que permite una gran durabilidad con el paso del tiempo.

Due to all external components with higher use being metallic, our tapware is very resistant over long periods of time.



**Ergonomia**  
Ergonomics

El diseño ergonómico de nuestras griferías permite el fácil uso para cualquier persona.

The ergonomic shape of our tapware offers ease of use.

**Custom**  
Custom

A petición del establecimiento hotelero, Ramon Soler graba a láser el logo del hotel de forma indeleble.

Ramon Soler can laser mark taps with an establishments logo on its handles making the tap a unique design item

# Confort Comfort

**Diamond finish**  
Diamond finish



La superficie de todas nuestras griferías son muy resistentes y poseen un acabado brillo extra gracias a un proceso de cromado y a rigurosos controles de calidad.

All of the tapware surfaces are extra resistant and have a shiny extra finish due to the extensive chroming and polishing process.

# Certificaciones

## Certifications

Ofrecemos anualmente más de 2.000 productos que cumplen con los estándares de calidad y las normativas europeas más exigentes.

We currently offer more than 2.000 products which comply with the highest european quality standards. Ramon Soler's quality exceeds the life cycle of the product, as we maintain a ten year stock in spare parts.



Certifica que un producto industrial o de consumo cumple las características de calidad definidas por la norma española y europea.

Certifies that the product fulfill the Spanish and the European standards.



Certificado a nivel Europeo claramente el volumen máximo de agua, si el producto se ha instalado correctamente y de acuerdo con las instrucciones del fabricante.

The maximum volume of water if the product has been installed correctly and according to the manufacturer's instructions.



La NF certifica que un producto industrial o de consumo cumple las características de calidad definidas por la norma francesa y europea.

NF Certification certifies that the product fulfill the French and the European standards



Certificación francesa que regula los materiales que tienen contacto con el agua.

French certification which regulates the materials in contact with water.



Federacion del sector del agua en Belgica.  
Belgian Federation for the Water Sector.



Regulación técnica obligatoria. La finalidad de una NOM es garantizar que el etiquetado de productos comercializados en el país, ya sean nacionales o importados, contengan la información comercial en español para que los consumidores puedan tomar una decisión de compra adecuada; otorgar confianza a los consumidores de que el producto es confiable; ampliar el poder de elección y evitar que el uso o consumo del producto represente un riesgo para la salud

Mandatory technical regulation. The purpose of an NOM is to ensure that the labeling of products marketed in the country, whether domestic or imported, contains commercial information in Spanish so that consumers can make an appropriate purchase decision; give consumers confidence that the product is reliable; expand the power of choice and prevent the use or consumption of the product represents a health risk



Certificación a fabricantes, empresas especializadas, de servicios públicos y expertos para proporcionar la prueba positiva de cumplimiento con el estado de la técnica de los requisitos.

Certification Body enables product manufacturers, specialist companies, utility companies and experts to furnish proof positive of compliance with state of the art requirements.



Agencia nacional del agua en Singapur.  
Singapore national water agency.



La Organización Egipcia de Estandarización (EOS) establece los criterios ecológicos de obligado cumplimiento en cuanto a eficiencia de consumo de agua, materiales en contacto con agua potable, sustancias prohibidas, longevidad de los productos, packaging e información al usuario. Disponer del etiquetado ECOLABEL es garantía del cumplimiento de nuestros productos con todos esos requisitos.

The Egyptian Organization for Standardization (EOS) establishes the mandatory ecological criteria regarding the efficiency of water consumption, materials in contact with drinking water, prohibited substances, product longevity, packaging and user information. Having the ECO-LABEL labeling is a guarantee of the fulfillment of our products with all those requirements.

# Proyectos en todo el mundo

## Projects around the world

Las griferías y duchas de Ramon Soler han sido certificadas con las normativas más exigentes y sus redes comerciales se extienden a más de 40 países. Con numerosas referencias hoteleras internacionales, la firma está presente en cadenas hoteleras. Millones de usuarios utilizan diariamente nuestros productos, renovando día a día su confianza. Ramon Soler se encuentran en las instalaciones más importantes: cadenas hoteleras internacionales, grandes hospitales, transatlánticos, grandes yates, hoteles con encanto, promociones de prestigio e incluso en promociones pioneras y sensibles al ahorro de agua y al medio ambiente.

The faucets and showers of Ramon Soler have been certified with the most restrictive standards and its commercial networks span more than 40 countries. With numerous International hotel references, the firm is present in hotel chains. Millions of consumers use our products every day, constantly confirming their confidence in us. Ramon Soler systems can be found at countless leading establishments: international hotel chains, large hospitals, ocean liners, super yachts, hotels with charm and even pioneering eco-friendly developments where water saving systems are installed.

**ramonsoler.**



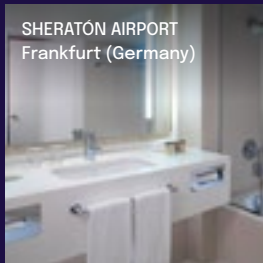

SHERATÓN AIRPORT  
Frankfurt (Germany)

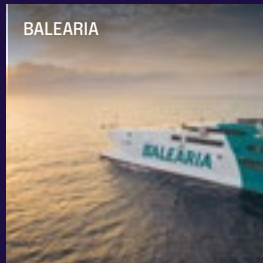

BALEARIA



POLICE HEADQUARTERS  
Frankfurt (Germany)

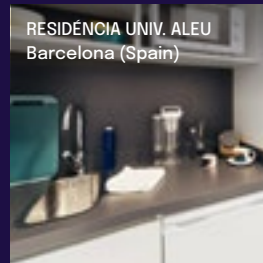

RESIDÈNCIA UNIV. ALEU  
Barcelona (Spain)



HOSPITAL ALGARVE  
Algarve (Portugal)

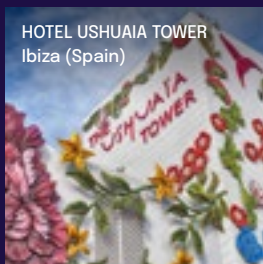

HOTEL USHUAIA TOWER  
Ibiza (Spain)



HOTEL INTERCONTINENTAL  
Tahiti (Polynesia)



HOTEL FERGUS  
Conil de la frontera (Spain)

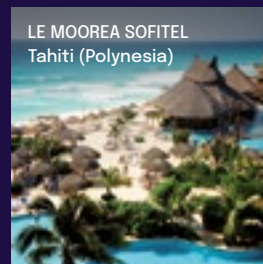

LE MOOREA SOFITEL  
Tahiti (Polynesia)



WINSTONFIELD APPARTAMENTS  
Germasogeia (Chipre)



HARD ROCK CAFE  
Ibiza (Spain)



WALDORF ASTORIA  
Dubai

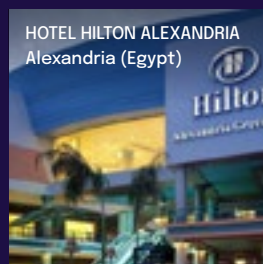

HOTEL HILTON ALEXANDRIA  
Alexandria (Egypt)

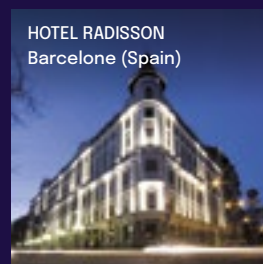

HOTEL RADISSON  
Barcelone (Spain)



BAWABAT ALSHARQ  
Abu Dhabi (UAE)

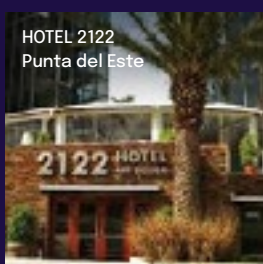

HOTEL 2122  
Punta del Este



GRAND PALLADIUM  
Lucea (Jamaica)

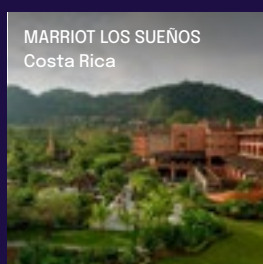

MARRIOTT LOS SUEÑOS  
Costa Rica

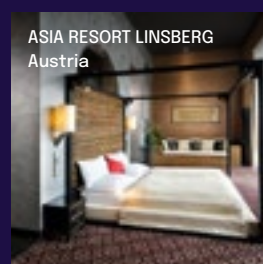

ASIA RESORT LINSBERG  
Austria



LE STADE DES LUMIÈRES  
Lyon (France)



DIAGONAL 640  
Barcelona (Spain)



SEDE CUATRECASAS  
Barcelone (Spain)

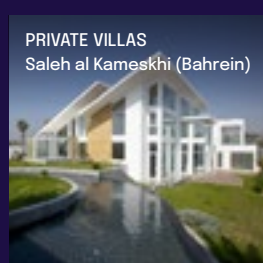

PRIVATE VILLAS  
Saleh al Kameskhi (Bahrein)



SERENADE PUNTA CANA  
República Dominicana

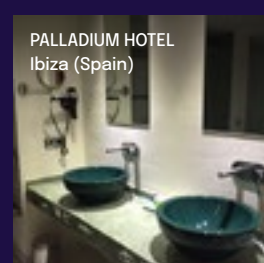

PALLADIUM HOTEL  
Ibiza (Spain)

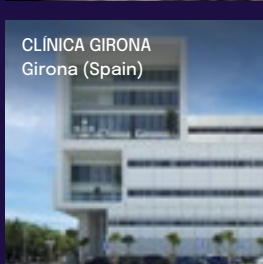

CLÍNICA GIRONA  
Girona (Spain)

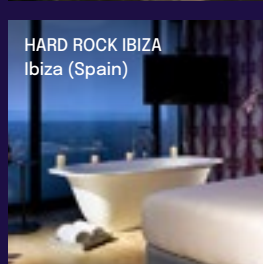

HARD ROCK IBIZA  
Ibiza (Spain)

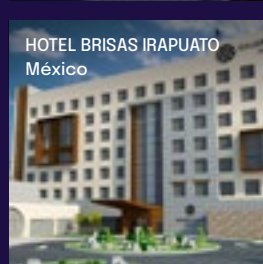

HOTEL BRISAS IRAPUATO  
México

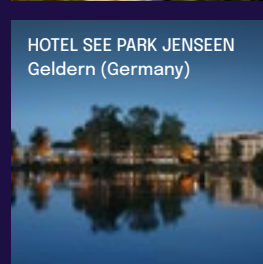

HOTEL SEE PARK JENSEN  
Geldern (Germany)



CITEÉ INTERNATIONAL LYON  
Lyon (France)





**NOVUM BY THE SEA**  
RUMANIA



**HOTEL FERGUS**  
JEREZ DE LA FRONTERA

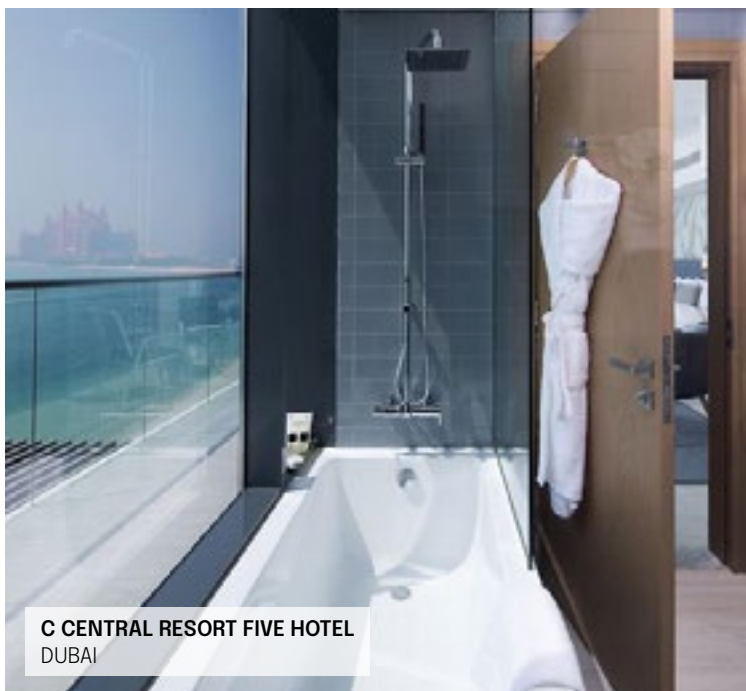

**C CENTRAL RESORT FIVE HOTEL**  
DUBAI



**THE USUAÏA TOWER**  
IBIZA

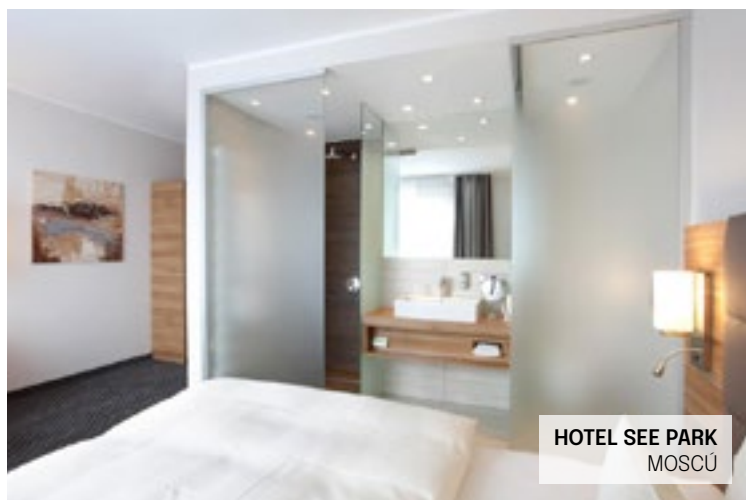

**HOTEL SEE PARK**  
MOSCÚ



**GRAN PALLADIUM RESORT&SPA**  
JAMAICA



**SERENADE BEACH&SPA RESORT**  
PUNTA CANA

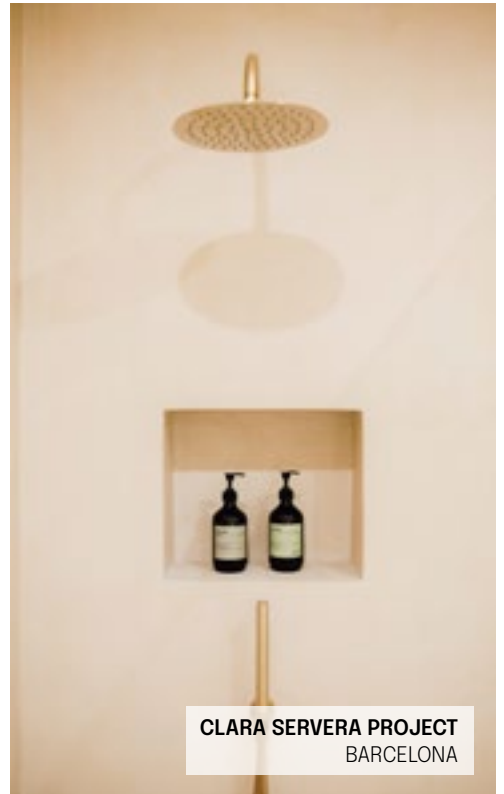

**CLARA SERVERA PROJECT**  
BARCELONA



**HOTEL SHERATON**  
FRANKFURT



**HOTEL PEDRO I ARAGÓN**  
HUESCA



**NEVA TOWERS**  
MOSCÚ



**HOUSE BY SCENA INTERIORDSIGN**  
ALEMANIA

# Odisea

Colección Collection

**N** New





### Características Técnicas

- Montura ceràmica de ½".
- Cartucho termostàtico con Sistema Hot Block de seguridad antiquemaduras y Sistema Termostop de bloqueo de la temperatura a 38°.
- Nivel acústico a 3 bar < 20 dB.
- Cromado latón: 15 micras de espesor de níquel, 0,3 micras de cromo.
- Presión de uso entre 1-5 bar, recomendada 3 bar. Resiste presiones estáticas ≤ 10 bar y golpes de ariete de 25 bar.
- Temperatura recomendada de agua caliente 55°C. Temperatura máxima de uso 65°C. Máximo 1h a 90°C.
- Resistente al choque térmico y químico anti-legionela.
- Cooltouch, sistema que permite mantener la grifería templada al tacto para evitar quemaduras.

### Technical Characteristics

- Ceramic ½" frame.
- Thermostatic cartridge with Hot Block anti-burn system and Termostop temperature blocking system (to 38°C).
- Acoustic level at 3 bars: < 20 dB.
- Chrome-plated brass: 15 microns thick of nickel, 0.3 microns of chrome.
- Working pressure between 1-5 bars, recommended: 3 bars. It resists static pressures ≤ 10 bars and water hammers of 25 bars.
- Recommended temperature for the hot water: 55°C. Maximum working temperature: 65°C. Maximum: 1h at 90°C.
- Resistant to thermal and anti-Legionella chemical shocks.
- Cooltouch, a system that keeps the faucet warm to the touch to avoid burns.



### Acabados disponibles Finishing availables



**Cromo**  
Chrome



**Negro mate**  
Black matte



**Oro cepillado**  
Brushed gold



**Cobre cepillado**  
Brushed copper





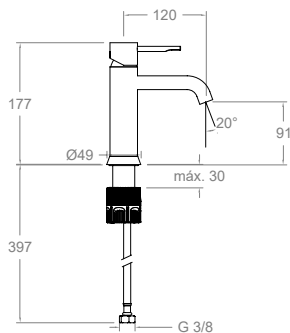

<b>390401</b> 39A307053	150,00 €	●
<b>390401NM</b> 39A307055	225,00 €	●
<b>390401OC</b> 39A307056	262,50 €	●
<b>390401CUC</b> 39A307250	262,50 €	●



Monomando de lavabo.  
Washbasin mixer.

Cartucho Cartridge: 35001-3

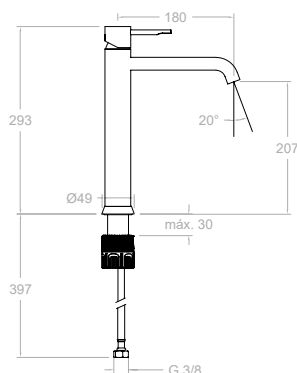

<b>390201</b> 39A307243	199,00 €	●
<b>390201NM</b> 39A307245	298,50 €	●
<b>390201OC</b> 39A307247	348,30 €	●
<b>390201CUC</b> 39A307251	348,30 €	●



Monomando de lavabo XL.  
Washbasin mixer XL.

Cartucho Cartridge: 35001-3

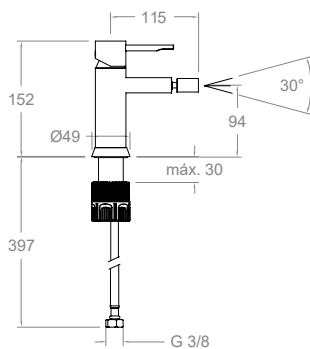

<b>390301</b> 39B307244	150,00 €	●
<b>390301NM</b> 39B307246	225,00 €	●
<b>390301OC</b> 39B307248	262,50 €	●
<b>390301CUC</b> 39B307252	262,50 €	●



Monomando de bidé.  
Bidet mixer.

Cartucho Cartridge: 35001-3

Recomendaciones Recommendations

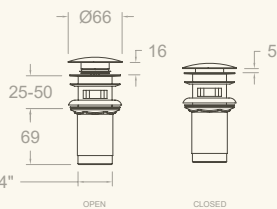
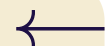

<b>1219L</b> 197106	27,40 €	●
<b>1219LNM</b> 99Z302477	41,10 €	●
<b>1219LOC</b> 99Z302478	48,30 €	●

Válvula metálica para desagüe sistema CLICK CLACK-Latón.  
Metal CLICK CLACK waste brass valve.

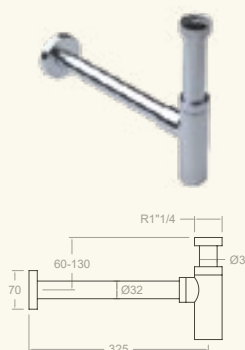

<b>3790</b> 198960	65,80 €	●
<b>3790NM</b> 99Z302332	100,90 €	●
<b>3790OC</b> 99Z302333	122,90 €	●

Sifón.  
Bottletrap.

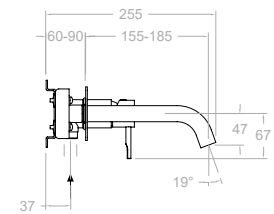
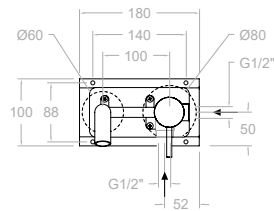

**392101** 271,20 €  
39A307430

**392101NM** 406,70 €  
39A307432

**392101OC** 474,50 €  
39A307434

**392101CUC** 474,50 €  
39A307436

Monomando de lavabo empotrado mural con caño de 19 cm.  
Wall washbasin mixer with 19 cm spout.



Cartucho Cartridge: 35100-2

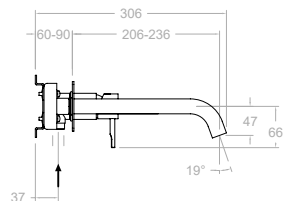
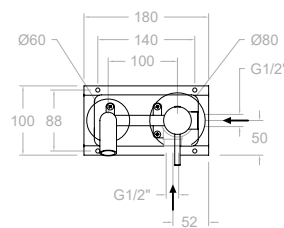

**392103** 281,30 €  
39A307431

**392103NM** 421,90 €  
39A307433

**392103OC** 492,20 €  
39A307435

**392103CUC** 492,20 €  
39A307437

Monomando de lavabo empotrado mural con caño de 24 cm.  
Wall washbasin mixer with 24 cm spout.



Cartucho Cartridge: 35100-2

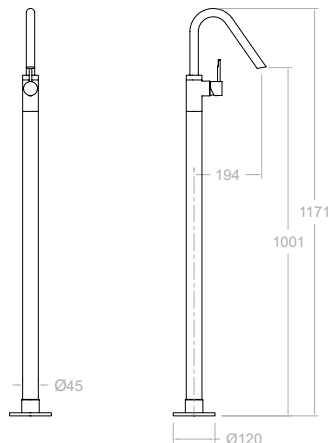

<b>397602S</b> 39A307485	924,90 €	●
<b>397602SNM</b> 39A307486	1.618,50 €	●
<b>397602SOC</b> 39A307487	1.618,50 €	●

Columna monomando de lavabo.  
Washbasin column.



Cartucho Cartridge: 35100-2

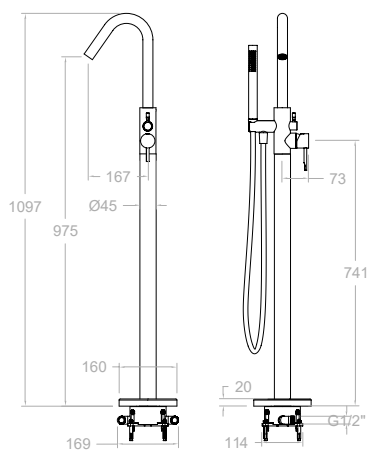

<b>398503S</b> 39C307496	1.219,00 €	●
<b>398503SNM</b> 39C307497	2.133,30 €	●
<b>398503SOC</b> 39C307498	2.133,30 €	●

Columna monomando para bañera.  
Free standing bath column.



<b>398503MO</b> 39C307489	1.282,20 €	●
<b>398503DNM</b> 39C307490	2.246,70 €	●
<b>398503DOC</b> 39C307491	2.246,70 €	●

Columna monomando para bañera con equipo de ducha.  
Free standing bath column with shower set.

XX1801	1bar	3bar	5bar
A l/min	17	26	31

Kit de ampliación - Extension set: KA1V

Cartucho Cartridge: 35100-2

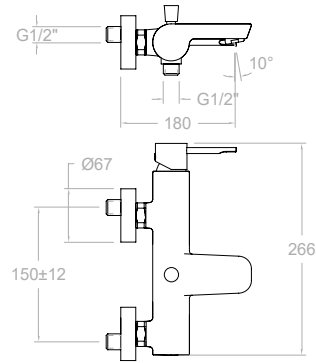

**390501S**  
39C307417

170,00 €



**390501SNM**  
39C307419

255,00 €



Monomando de baño-ducha.  
Bath and shower mixer.



Cartucho Cartridge: 35100 (6689-2)



**390501MO**  
39C307416

275,90 €



390501S+3713M+3726M+2471C

Conjunto monomando de baño-ducha con equipo de ducha.  
Bath and shower mixer with shower set.

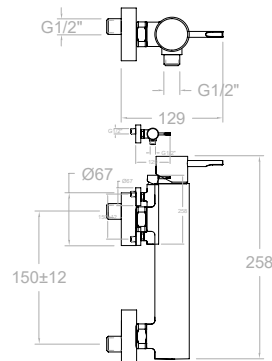

**390801S**  
39D307424

137,00 €



**390801SNM**  
39D307426

205,10 €



Monomando de ducha.  
Shower mixer.



Cartucho Cartridge: 35100-3



**390801MO**  
39D307423

242,90 €



390801S+3713M+3726M+2471C

Conjunto monomando de ducha con equipo de ducha.  
Shower mixer with shower set.



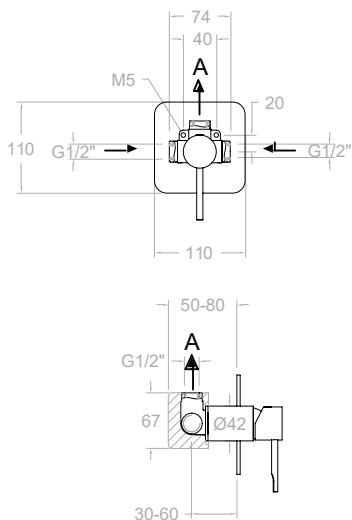

- 391801S** 113,50 €  
39D307473
- 391801SNM** 198,60 €  
39D307475
- 391801SOC** 198,60 €  
39D307476
- 391801SCUC** 198,60 €  
39D307477



**Monomando de ducha empotrado 1 vía con placa metálica.**  
Single lever concealed mixer 1 way with ultraslim metallic plate.

XX1801	1bar	3bar	5bar
A l/min	17	26	34

Kit de ampliación - Extension set: KA1V

**1 Vía/Way**

Cartucho Cartridge: 35100 (6689-2)

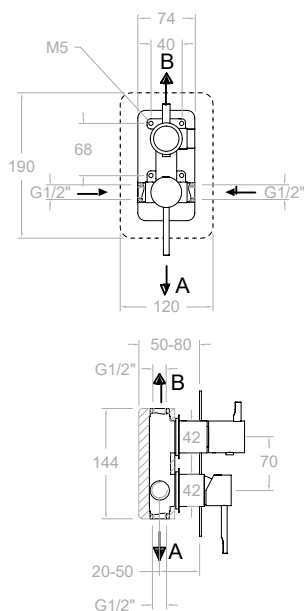

- 391512S** 206,40 €  
39D307323
- 391512SNM** 361,30 €  
39D307482
- 391512SOC** 361,30 €  
39D307324
- 391512SCUC** 361,30 €  
39D307484



**Monomando de ducha empotrado 2 vías con placa metálica.**  
Single lever concealed mixer 2 ways with ultraslim metallic plate.

XX1502	1bar	3bar	5bar
A l/min	14	24	30
B l/min	13	22	29

Kit de ampliación - Extension set: KA2V

**2 Vías/Ways**

Cartucho Cartridge: 35100 (6689-2) + 4004

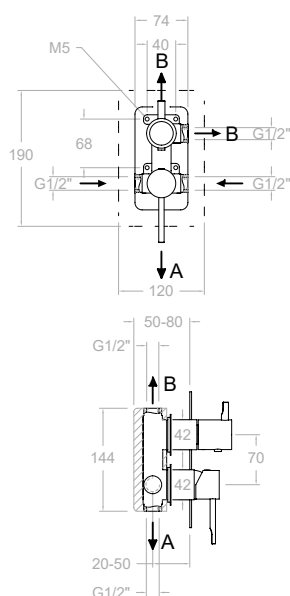

- 391513S** 227,00 €  
39D307478
- 391513SNM** 397,30 €  
39D307479
- 391513SOC** 397,30 €  
39D307480
- 391513SCUC** 397,30 €  
39D307481



**Monomando de ducha empotrado 3 vías con placa metálica.**  
Single lever concealed mixer 3 ways with ultraslim metallic plate.

XX1503	1bar	3bar	5bar
A l/min	14	24	30
B l/min	13	22	29
B l/min	13	21	26

Kit de ampliación - Extension set: KA3V

**3 Vías/Ways**

Cartucho Cartridge: 35100 (6689-2) + 4003





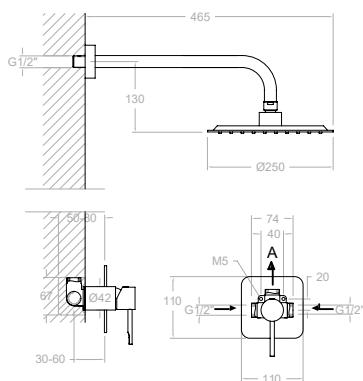

- K3918012** 338,40 €  
 39D307500  
 391801S-BHRM250
- K3918012NM** 592,20 €  
 39D307502  
 391801SNM-BHRM250NM
- K3918012OC** 592,20 €  
 39D307503  
 391801SOC-BHRM250OC
- K3918012CUC** 592,20 €  
 39D307504  
 391801SCUC-BHRM250CUC



Conjunto monomando empotrado 1 vía con rociador metálico Ø 250 mm.  
 Shower set with concealed single lever 1 way mixer, metallic headshower Ø 250 mm.

1 Vía/Way

XX1801	1bar	3bar	5bar
A l/min	17	26	34

Kit de ampliación - Extension set: KA1V

Cartucho Cartridge: 35100 (6689-2)

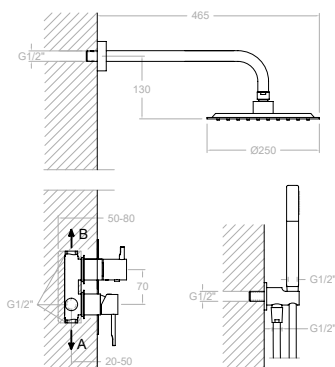

- K3915021** 538,60 €  
 39D307505  
 391512S-BHRM250+3713M+3796+2471C
- K3915021NM** 942,60 €  
 39D307506  
 391512SNM-BHRM250NM+3714NM+3796NM+2475CNM
- K3915021OC** 942,60 €  
 39D307507  
 391512SOC-BHRM250OC+3714OC+3796OC+2475COC
- K3915021CUC** 942,60 €  
 39D307508  
 391512SCUC-BHRM250CUC+3714CUC+3796CUC+2475CCUC



Conjunto monomando empotrado 2 vías con rociador metálico Ø 250 mm.  
 Shower set with concealed single lever 2 ways mixer, water outlet, handshower, metallic headshower Ø 250 mm.

2 Vias/Ways

XX1801	1bar	3bar	5bar
A l/min	17	26	34

Kit de ampliación - Extension set: KA1V

Cartucho Cartridge: 35100 (6689-2)





1 Vía/Way

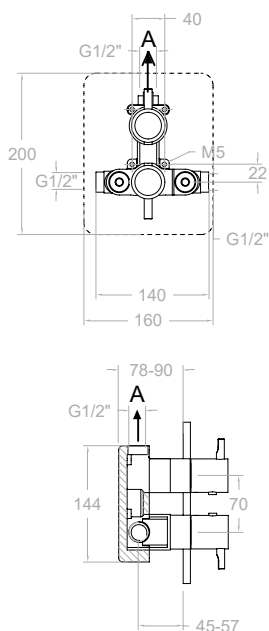

- 392421S** 193,80 €  
 39D307592  
 XX2421+KTX1+395000+395000
- 392421SNM** 339,20 €  
 39D307593  
 XX2421NM+KTX1NM+395000NM+395000NM
- 392421SOC** 339,20 €  
 39D307594  
 XX2421OC+KTX1OC+395000OC+395000OC
- 392421SCUC** 339,20 €  
 39D307595  
 XX2421CUC+KTX1CUC+395000CUC+395000CUC

Termostático de ducha empotrado 1 vía con placa metálica.  
Thermostatic shower mixer with shower set.

XX2411S	1bar	3bar	5bar
A l/min	17	26	31

Kit de ampliación - Extension set: KAETI04



Cartucho Cartridge: 1703T + 1700C3/4"



2 Vías/Ways

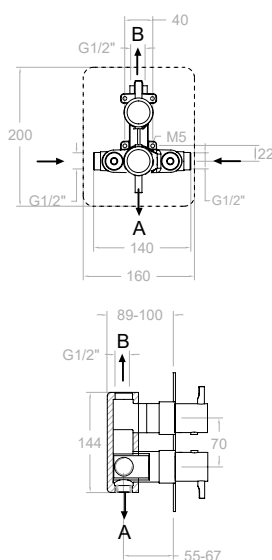

- 398722S** 271,20 €  
 39D307596  
 XX8722+KTX2+395000+395000
- 398722SNM** 474,60 €  
 39D307597  
 XX8722SNM+KTX2NM+395000NM+395000NM
- 398722SOC** 474,60 €  
 39D307598  
 XX8722SOC+KTX2OC+395000OC+395000OC
- 398722SCUC** 474,60 €  
 39D307599  
 XX8722SCUC+KTX2CUC+395000CUC+395000CUC

Termostático de ducha empotrado 2 vías con placa metálica.  
Thermostatic concealed mixer 2 ways with ultraslim metallic plate.

XX8712	1bar	3bar	5bar
A l/min	14	24	30
B l/min	13	22	28

Kit de ampliación - Extension set: KAETI03



Cartucho Cartridge: 1703T + 4000

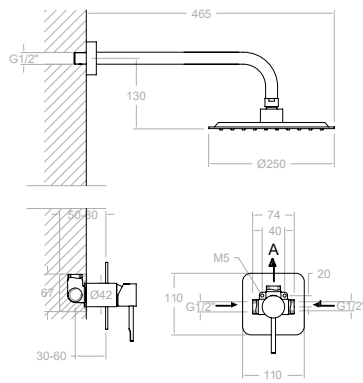

<b>K3924012</b> 39D307601 392421S+BHRM250	418,70 €	
<b>K3924012NM</b> 39D307602 392421SNM+BHRM250NM	732,80 €	
<b>K3924012OC</b> 39D307603 392421SOC+BHRM250OC	732,80 €	
<b>K3924012CUC</b> 39D307604 392411SCUC+BHRM250CUC	732,80 €	



**Conjunto monomando empotrado 1 vía con rociador metálico Ø 250 mm.**  
Shower set with concealed single lever 1 way mixer, metallic headshower Ø 250 mm.

**1 Vía/Way**

XX1801	1bar	3bar	5bar
A l/min	17	26	34
Kit de ampliación - Extension set: KAIV			

Cartucho Cartridge: 35100 (6689-2)



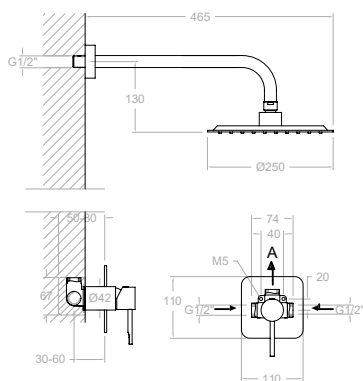

**K3987011** 603,40 €

39D307605  
398722S+BHRM250+3713M+3796+2472C ●

**K3987011NM** 1.056,00 €

39D307606  
398722SNM+BHRM250NM+3714NM+3796NM+2475CNM ●

**K3987011OC** 1.056,00 €

39D307607  
398722SOC+BHRM250OC+3714OC+3796OC+2475COC ●

**K3987011CUC** 1.056,00 €

39D307608  
398712SCUC+BHRM250CUC+3714CUC+3796CUC+2475CCUC ●

Conjunto monomando empotrado 2 vías con rociador metálico Ø 250 mm.

Shower set with concealed single lever 2 ways mixer, metallic headshower Ø 250 mm.

XX1801	1bar	3bar	5bar
A l/min	17	26	34

Kit de ampliación - Extension set: KA1V



2 Vías/Ways

Cartucho Cartridge: 35100 (6689-2)

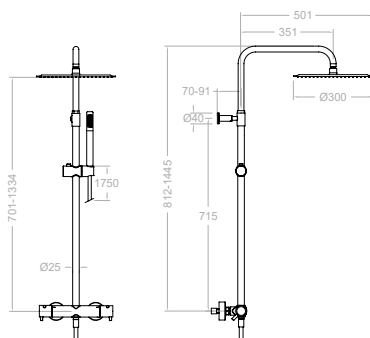

**395401RM300** 722,80 €

39D307610  
391202S+DN132D+RM300+3713M+2472C ●

**395401RM300NM** 1.264,80 €

39D307611  
391202SNM+DN132DNM+RM300NM+3714NM+2475CNM ●

**395401RM300OC** 1.264,80 €

39D307612  
391202SOC+DN132DOC+RM300OC+3714OC+2475COC ●

**395401RM300CUC** 1.264,80 €

39D307613  
391202SCUC+DN132DCUC+RM300CUC+3714CUC+2475CCUC ●

Columna telescópica termostática con ducha de mano y rociador metálico Ø 300 mm.

Thermostatic shower telescopic column, metallic round headshower Ø 300 mm and metallic accessories.

XX1801	1bar	3bar	5bar
A l/min	17	26	34

Kit de ampliación - Extension set: KA1V



Cartucho Cartridge: 35100 (6689-2)



## Odisea Joya

Espíritu innovador en una colección de griferías con historia.  
The spirit of innovation in a historic tapware collection.

Odisea Joya presenta un diseño excepcional, un cuerpo cilíndrico con una base en forma de faldón y un caño cilíndrico y fino, con una singular inclinación para una salida del agua más precisa y controlada. El mando es uno de sus elementos más característicos, gracias a sus dimensiones controladas y a su manecilla redondeada con una muesca en su extremo.

El cuerpo de Odisea Joya expresan movimiento y dinamismo, cualidades propias de la arquitectura contemporánea que recuerdan a obras como el "Edificio Chrysler" en Manhattan, de William Van Alen, o la torre "30 St Mary Axe" en Londres, de Norman Foster. Un diseño inspirado en la reconocida serie Joya, creada en 1968 por el mismo Ramon Soler Roger, fundador de Ramon Soler.

Odisea Joya has an exceptional design consisting of a cylindrical body with a flared base and a slim, cylindrical shaft with a singular inclination for a more precise, controlled water flow. The handle is one of its most characteristic elements, thanks to its controlled dimensions and its rounded lever with a notch at the end.

The body of the Odisea Joya express movement and dynamism, qualities of modern architecture that remind us of structures such as the "Chrysler Building" in Manhattan, by William Van Alen, or the "30 St Mary Axe" Tower in London, by Norman Foster. It has a rhomboid design, inspired by the famous Joya series created in 1968 by Ramon Soler Roger, the founder of Ramon Soler.





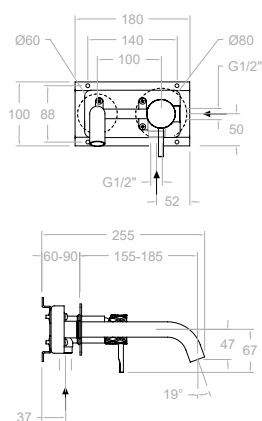

<b>592101</b> 59A307439	338,90 €	●
<b>592101OC</b> 59A307441	593,10 €	●
<b>592101CUC</b> 59A307443	593,10 €	●

Monomando de lavabo empotrado mural con caño de 19 cm.  
Wall washbasin mixer with 19 cm spout.

1805S + 655501 D1 (3524D1+3544+1128C)

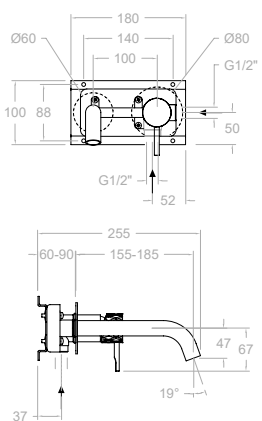

<b>592103</b> 59A307440	351,60 €	●
<b>592103OC</b> 59A307442	615,30 €	●
<b>592103CUC</b> 59A307444	615,30 €	●

Monomando de lavabo empotrado mural con caño de 24 cm.  
Wall washbasin mixer with 24 cm spout.

Cartucho Cartridge: 40200-2



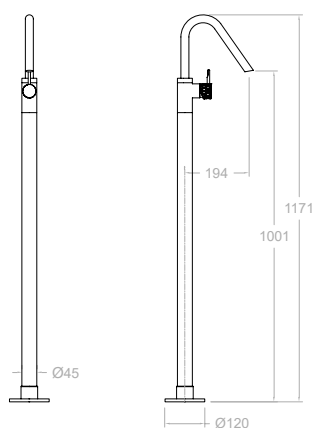

**597602S** 1.156,10 €

59A307694 ●

**597602SOC** 2.023,10 €

59A307695 ●

Columna monomando de lavabo.  
Washbasin column.



Montura Head: 1701C1/2 + 1702C1/2

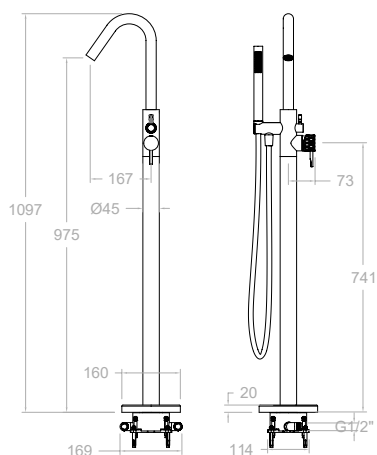

**598503S** 1.523,80 €

59C307701 ●

**598503SOC** 2.666,60 €

59C307702 ●

Columna monomando para bañera.  
Free standing bath column.



Montura Head: 1701C1/2 + 1702C1/2

**598503MO** 1.587,00 €

59C307697 ●

Columna monomando para bañera con equipo de ducha.  
Free standing bath column with shower set.



**598503DOC** 2.780,00 €

59C307699 ●

Columna monomando para bañera con equipo de ducha.  
Free standing bath column with shower set.

Montura Head: 1701C1/2 + 1702C1/2



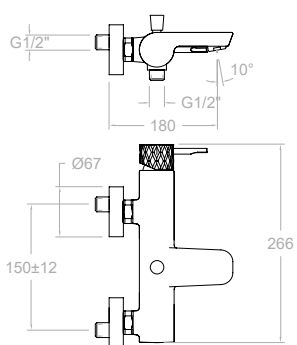

**590501S**

59C307422

212,50 €

Monomando de baño-ducha.  
Bath and shower mixer.



Cartucho Cartridge: 35100 (6689-2)



MO

**590501MO**

59C307421

318,40 €

Conjunto monomando de baño-ducha con equipo de ducha.  
Bath and shower mixer with shower set.



590501S-3713M+3726M+2471C

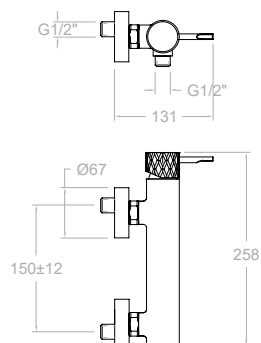

**590801S**

59D307428

171,30 €

Monomando de ducha.  
Shower mixer.



Cartucho Cartridge: 35100-3



MO

**590801MO**

59D307427

277,20 €

Conjunto monomando de ducha con equipo de ducha.  
Shower mixer with shower set.

1805S+351502+3544+1128C



1 Vía/Way

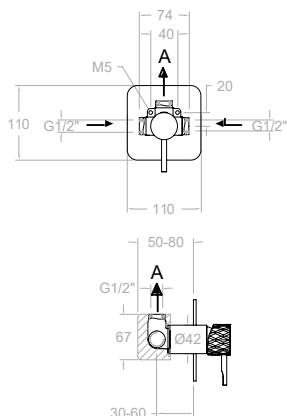

- 591801S** 59D307685 141,90 € ●
- 591801SOC** 59D307686 248,30 € ●
- 591801SCUC** 59D307687 248,30 € ●

Monomando de ducha empotrado 1 vía con placa metálica.  
Single lever concealed mixer 1 way with ultraslim metallic plate.

XX1801	1bar	3bar	5bar
A l/min	17	26	34

Kit de ampliación - Extension set: KA1V



Cartucho Cartridge: 35100 (6689-2)



2 Vías/Ways

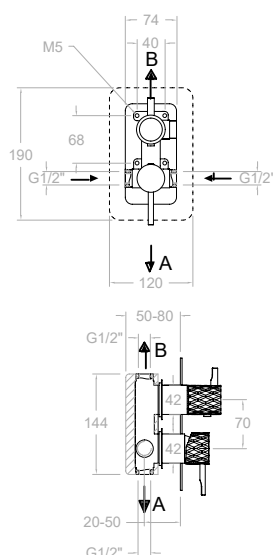

- 591512S** 59D307688 258,00 € ●
- 591512SOC** 59D307689 451,60 € ●
- 591512SCUC** 59D307690 451,60 € ●

Monomando de ducha empotrado 2 vías con placa metálica.  
Single lever concealed mixer 2 ways with ultraslim metallic plate.

XX1502	1bar	3bar	5bar
A l/min	14	24	30
B l/min	13	22	29

Kit de ampliación - Extension set: KA2V



Cartucho Cartridge: 35100 (6689-2) + 4004



3 Vías/Ways

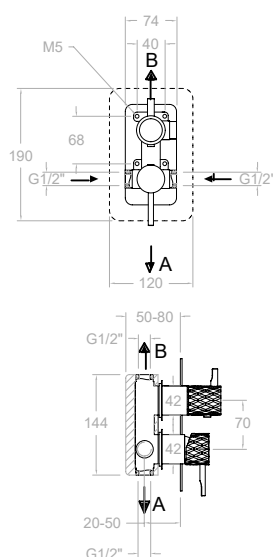

- 591513S** 59D307691 283,80 € ●
- 591513SOC** 59D307692 496,60 € ●
- 591513SCUC** 59D307693 496,60 € ●

Monomando de ducha empotrado 3 vías con placa metálica.  
Single lever concealed mixer 3 ways with ultraslim metallic plate.

XX1502	1bar	3bar	5bar
A l/min	14	22	28
B l/min	13	21	26
B l/min	13	21	26

Kit de ampliación - Extension set: KA3V



Cartucho Cartridge: 35100 (6689-2) + 4003

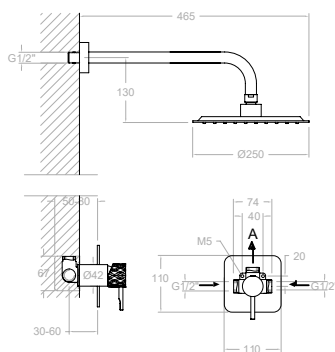

**K5918012** 373,50 €  
 59D307704  
 591801S-BHRM250

**K5918012OC** 665,10 €  
 59D307705  
 591801SOC-BHRM250OC

**K5918012CUC** 665,10 €  
 59D307706  
 591801SCUC-BHRM250CUC

Conjunto monomando empotrado 1 vía con rociador metálico Ø 250 mm.  
 Shower set with concealed single lever 1 way mixer, metallic headshower Ø 250 mm.



**1 Vía/Way**

XX1801	1bar	3bar	5bar
A l/min	17	26	34

Kit de ampliación - Extension set: KA1V

Cartucho Cartridge: 35100 (6689-2)

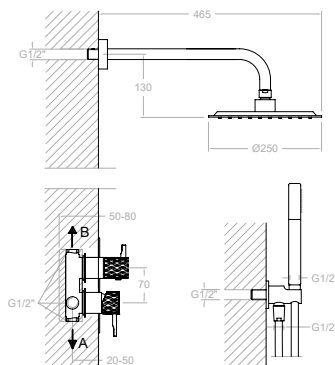

**K5915021** 600,20 €  
 59D307707  
 591512S+BHRM250+3713M+3796+2471C

**K5915021OC** 1.067,20 €  
 59D307708  
 591512SOC-BHRM250OC+3714OC+3796OC+2475COC

**K5915021CUC** 1.067,20 €  
 59D307709  
 591512SCUC-BHRM250CUC+3714CUC+3796CUC+2475CCUC

Conjunto monomando empotrado 2 vías con rociador metálico Ø 250 mm.  
 Shower set with concealed single lever 2 ways mixer, water outlet, handshower, metallic headshower Ø 250 mm.



XX1502	1bar	3bar	5bar
A l/min	14	24	30
B l/min	13	22	29

Kit de ampliación - Extension set: ka2v

Cartucho Cartridge: 35100 (6689-2)+4004

**2 Vias/Ways**

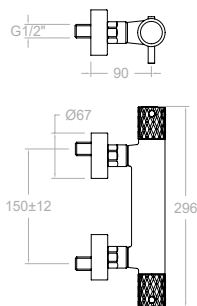

MO



D



**593401S** 322,10 €  
59D307710 ●

**593401SOC** 563,70 €  
59D307711 ●

**593401SCUC** 563,70 €  
59D307712 ●

Termostático de ducha.  
Thermostatic shower mixer.

**593401MO** 428,00 €  
59D307713 ●

**593401DOC** 754,00 €  
59D307714 ●

**593401DCUC** 754,00 €  
59D307715 ●

Termostático de ducha con equipo de ducha.  
Thermostatic shower mixer with shower set.

Cartucho Cartridge: 35100-3

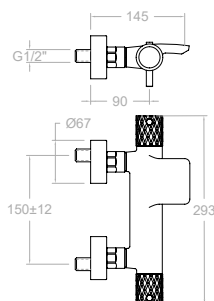

MO



D



**593901S** 391,90 €  
59C307716 ●

**593901SOC** 685,90 €  
59C307717 ●

**593901SCUC** 685,90 €  
59C307718 ●

Termostático de bañera.  
Thermostatic bath and shower mixer.

**593901MO** 497,80 €  
59C307719 ●

590501S-3713M+3726M+2471C

**593901DOC** 876,20 €  
59C307720 ●

**593901DCUC** 876,20 €  
59C307721 ●

Termostático de bañera con equipo de ducha.  
Thermostatic bath and shower mixer with shower set.

1805S-351502+3544+2450C

Cartucho Cartridge: 35100-3



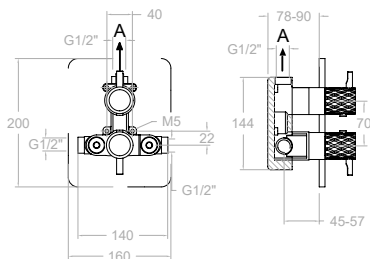

<b>592421S</b> 59D307722 XX2421+KTX1+595000+595000	242,30 €	●
<b>592421SOC</b> 59D307723 XX2421OC+KTX1OC+595000OC+595000OC	424,00 €	●
<b>592421SCUC</b> 59D307724 XX2421CUC+KTX1CUC+595000CUC+595000CUC	424,00 €	●



Termostático de ducha empotrado 1 vía con placa metálica cromado.  
Thermostatic concealed mixer 1 way with ultraslim metallic plate.

1 Vía/Way

1805S + 655501 D1 (3524D1+3544+1128C)

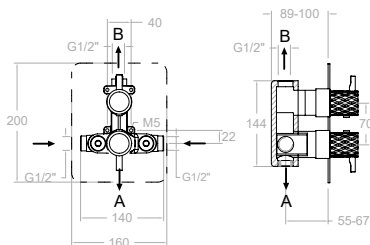

<b>598722S</b> 59D307725 XX8722+KTX2+595000+595000	339,00 €	●
<b>598722SOC</b> 59D307726 XX8722SOC+KTX2OC+595000OC+595000OC	593,30 €	●
<b>598722SCUC</b> 59D307727 XX8722SCUC+KTX2CUC+595000CUC+595000CUC	593,30 €	●



Termostático de ducha empotrado 2 vías con placa metálica cromado.  
Thermostatic concealed mixer 2 ways with ultraslim metallic plate.

2 Vías/Ways

1805S + 655501 D1 (3524D1+3544+1128C)



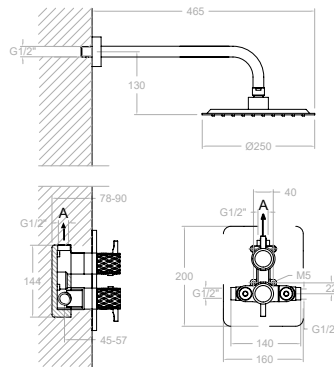

<b>K5924012</b> 59D307728 592421S+BHRM250	473,90 €	●
<b>K5924012OC</b> 59D307729 592421SOC+BHRM250OC	840,80 €	●
<b>K5924012CUC</b> 59D307730 592421SCUC+BHRM250CUC	840,80 €	●



Conjunto termostático empotrado 1 vía con rociador metálico Ø 250 mm.  
Shower set with concealed thermostatic 1 way mixer, metallic headshower Ø 250 mm.

1 Vía/Way

XX1801	1bar	3bar	5bar
A l/min	17	26	34

Kit de ampliación - Extension set: KAIV

Cartucho Cartridge: 35100 (6689-2)

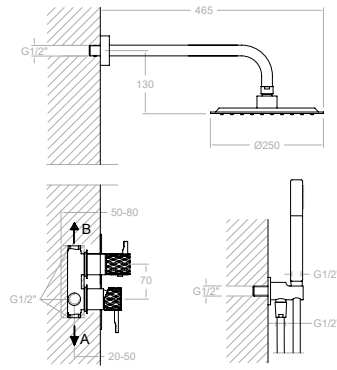

**K5987011** 681,20 €

59D307731  
598722S-BHRM250+3713M+3796+2472C

**K5987011OC** 1.208,90 €

59D307732  
598722SOC+BHRM250OC+3714OC+3796OC+2475COC

**K5987011CUC** 1.208,90 €

59D307733  
598722SCUC+BHRM250CUC+3714CUC+3796CUC+2475CCUC

Conjunto termostático empotrado 2 vías con ducha de mano y rociador metálico Ø 250 mm.

Shower set with concealed thermostatic 2 ways mixer, water outlet, handshower, metallic headshower Ø 250 mm.

XX1502	1bar	3bar	5bar
A l/min	14	24	30
B l/min	13	22	29

Kit de ampliación - Extension set: ka2v



**2 Vías/Ways**

Cartucho Cartridge: 35100 (6689-2)+4004

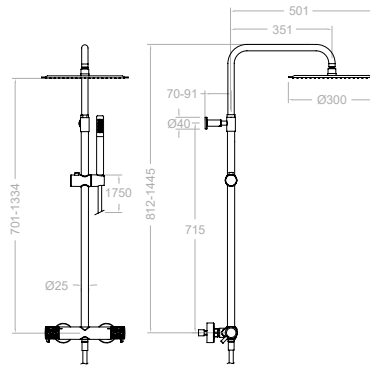

**595401RM300** 903,50 €

59D307734  
591202S+DN132D+RM300+3713M+2472C

**595401RM300OC** 1.581,00€

59D307736  
591202SOC+DN132DOC+RM300OC+3714OC+2475COC

**595401RM300CUC** 1.581,00€

59D307737  
591202SCUC+DN132DCUC+RM300CUC+3714CUC+2475CCUC

Columna telescópica termostática con ducha de mano y rociador metálico Ø 300 mm.

Thermostatic shower telescopic column, metallic round headshower Ø300mm and metallic accessories.



Cartucho Cartridge: 35100 (6689-2)+4004



# Adagio

Colección Collection



VER VIDEO  
WATCH VIDEO



## Características Técnicas

- Montura bimando cerámica de ½" de abertura 90°.
- Cartucho termostático con Sistema Hot Block de seguridad antiquemaduras y Sistema Termostop de bloqueo de la temperatura a 38°.
- Caudal a 3 bar: Lavabo, Bidet y Fregadero (de 9 a 12 l/min). Ducha (de 12 a 16 l/min). Baño (≥20 l/min).
- Nivel acústico a 3 bar < 20 dB.
- Cromado latón: 15 micras de espesor de níquel, 0,3 micras de cromo.
- Presión de uso entre 1-5 bar, recomendada 3 bar. Resiste presiones estáticas ≤ 10 bar y golpes de ariete de 25 bar.
- Temperatura recomendada de agua caliente 55°C. Temperatura máxima de uso 65°C. Máximo 1h a 90°C.
- Resistente al choque térmico y químico anti-legionela.
- Cooltouch, sistema que permite mantener la grifería templada al tacto para evitar quemaduras.

## Technical Characteristics

- Ceramic twin handle ½" frame opening 90°.
- Thermostatic cartridge with Hot Block anti-burn system and Termostop temperature blocking system (to 38°C).
- Flow rate at 3 bars: Washbasin, bidet and sink (from 9 to 12 l/min.); Shower (from 12 to 16 l/min.); and Bath (≥20 l/min.).
- Acoustic level at 3 bars: < 20 dB.
- Chrome-plated brass: 15 microns thick of nickel, 0.3 microns of chrome.
- Working pressure between 1-5 bars, recommended: 3 bars. It resists static pressures ≤ 10 bars and water hammers of 25 bars.
- Recommended temperature for the hot water: 55°C. Maximum working temperature: 65°C. Maximum: 1h at 90°C.
- Resistant to thermal and anti-Legionella chemical shocks.
- Cooltouch, a system that keeps the faucet warm to the touch to avoid burns.



## Acabados disponibles / Finishing availables



Cromo  
Chrome



Negro mate  
Black matte



Oro cepillado  
Brushed gold







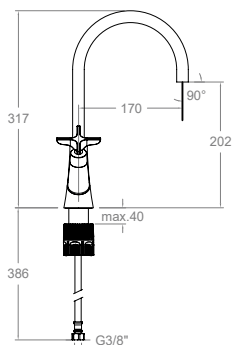

<b>910101</b> 91A306076	245,80 €	●
<b>910101NM</b> 91A306109	368,50 €	●
<b>910101OC</b> 91A306126	430,00 €	●



Bimando de lavabo con caño 170 mm giratorio.  
Two handle washbasin mixer with swivel spout 170 mm.

Montura Head: 1701C1/2 + 1702C1/2

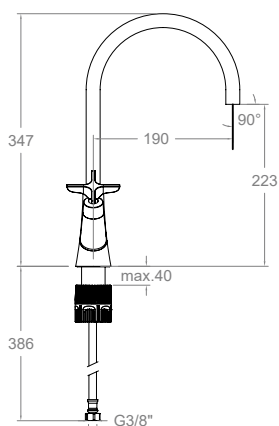

<b>910102</b> 91A306078	256,70 €	●
<b>910102NM</b> 91A306110	385,00 €	●
<b>910102OC</b> 91A306127	449,20 €	●



Bimando de lavabo con caño 190 mm giratorio.  
Two handle washbasin mixer with swivel spout 190 mm.

Montura Head: 1701C1/2 + 1702C1/2

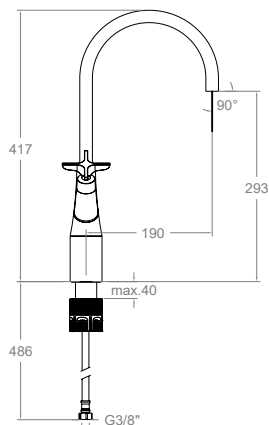

<b>911001</b> 91A306094	380,70 €	●
<b>911001NM</b> 91A306111	570,90 €	●
<b>911001OC</b> 91A306128	666,20 €	●



Bimando de lavabo alto con caño 190 mm giratorio.  
Two handle high washbasin mixer with swivel spout 190 mm.

Montura Head: 1701C1/2 + 1702C1/2

Recomendaciones Recommendations

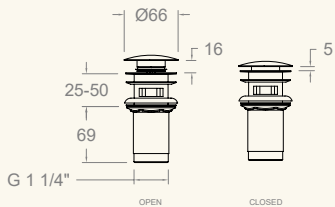

<b>1219L</b> 197106	27,40 €	●
<b>1219LNM</b> 99Z302477	41,10 €	●
<b>1219LOC</b> 99Z302478	48,30 €	●

Válvula metálica para desagüe sistema CLICK CLACK-Latón.  
Metal CLICK CLACK waste brass valve.

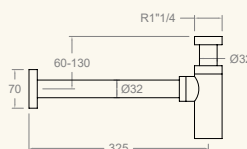

<b>3790</b> 198960	65,80 €	●
<b>3790NM</b> 99Z302332	100,90 €	●
<b>3790OC</b> 99Z302333	122,90 €	●

Sifón  
Bottletrap

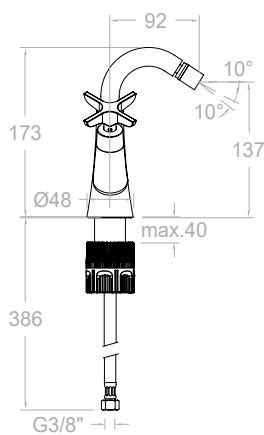

<b>910301</b> 91B307902	230,70 €	<b>N</b>
<b>910301NM</b> 91B307903	346,10 €	<b>N</b>
<b>910301OC</b> 91B307904	403,80 €	<b>N</b>

Bimando de bidé.  
Bidet mixer.



Disponibile en Mayo  
Available to May

Montura Head: 1701C1/2 + 1702C1/2

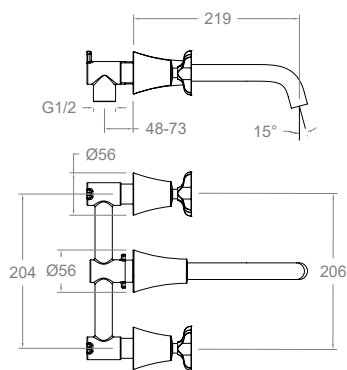

<b>912001</b> 91A306096	307,10 €	●
<b>912001NM</b> 91A306113	460,70 €	●
<b>912001OC</b> 91A306130	537,60 €	●

Bimando de lavabo empotrado mural.  
Concealed washbasin two handle mixer.



Montura Head: 1701C1/2 + 1702C1/2

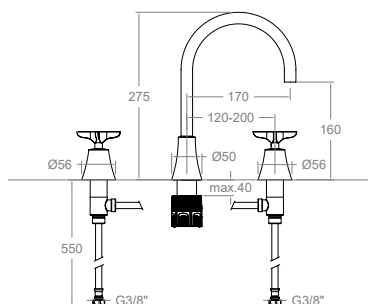

<b>914201</b> 91A306098	356,50 €	●
<b>914201NM</b> 91A306115	534,80 €	●
<b>914201OC</b> 91A306132	624,00 €	●

Bimando de lavabo para repisa. Caño giratorio de 170 mm.  
Washbasin 3 hole mixer spout 170 mm.



Montura Head: 1701C1/2 + 1702C1/2

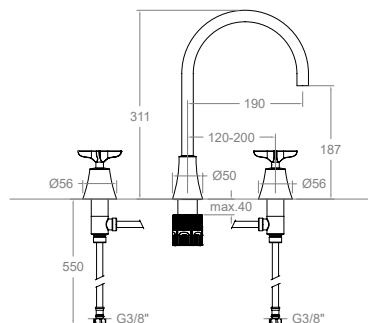

<b>914202</b> 91A306099	367,50 €	●
<b>914202NM</b> 91A306116	551,30 €	●
<b>914202OC</b> 91A306133	643,10 €	●

Bimando de lavabo para repisa. Caño giratorio de 190 mm.  
Washbasin 3 hole mixer spout 190 mm.



Montura Head: 1701C1/2 + 1702C1/2

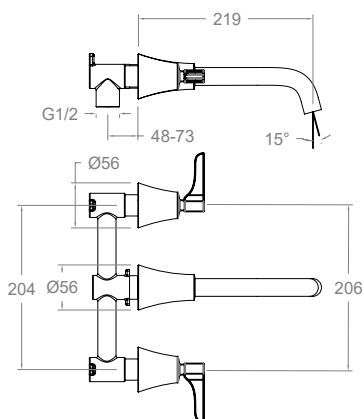

<b>912001ML</b> 91A306097	307,10 €	●
<b>912001MLNM</b> 91A306114	460,70 €	●
<b>912001MLOC</b> 91A306131	537,60 €	●

Bimando de lavabo empotrado mural maneta Adagietto.  
Concealed washbasin two Adagietto handle mixer.



Montura Head: 1701C1/2 + 1702C1/2

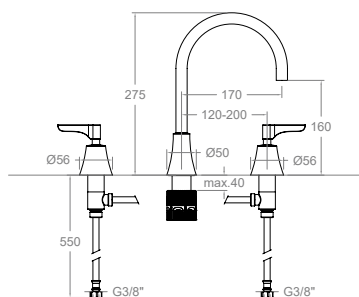

<b>914201ML</b> 91A306100	356,50 €	●
<b>914201MLNM</b> 91A306117	534,80 €	●
<b>914201MLOC</b> 91A306134	624,00 €	●

Bimando de lavabo para repisa maneta Adagietto. Caño giratorio de 170 mm.  
Washbasin 3 hole mixer Adagietto handle, spout 170 mm.



Montura Head: 1701C1/2 + 1702C1/2

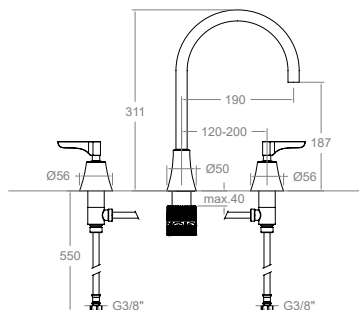

<b>914202ML</b> 91A306101	367,50 €	●
<b>914202MLNM</b> 91A306118	551,30 €	●
<b>914202MLOC</b> 91A306135	643,10 €	●

Bimando de lavabo para repisa, maneta Adagietto. Caño giratorio de 190 mm.  
Washbasin 3 hole mixer Adagietto handle, spout 190 mm.



Montura Head: 1701C1/2 + 1702C1/2



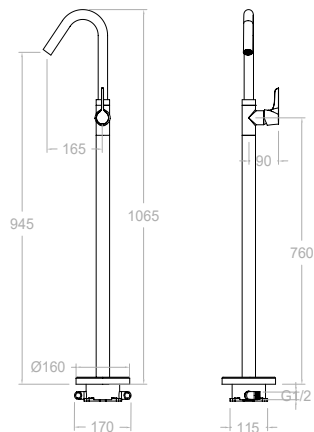

<b>917602</b> 91A306102	976,30 €	●
<b>917602NM</b> 91A306119	1.708,50 €	●
<b>917602OC</b> 91A306136	1.708,50 €	●

Monomando lavabo de columna.  
Free standing washbasin column



Cartucho Cartridge: 35100-2

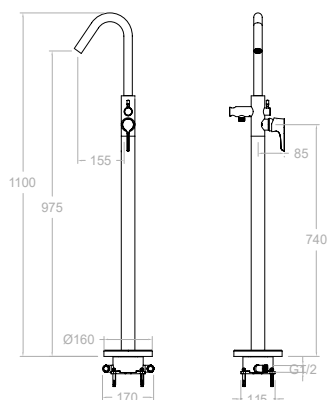

<b>918503S</b> 91C306103	1.305,40 €	●
<b>918503SNM</b> 91C306120	2.284,40 €	●
<b>918503SOC</b> 91C306137	2.284,40 €	●

Columna monomando para bañera.  
Free standing bath shower column.

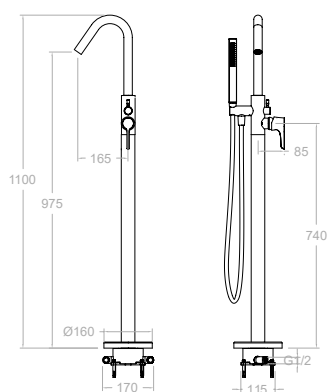

<b>918503MO</b> 91C306308 918503S+3713M+2471C	1.368,50 €	●
<b>918503DNM</b> 91C306309 918503SNM+3714NM+2475CNM	2.397,30 €	●
<b>918503DOC</b> 91C306310 918503SOC+3714OC+2475COC	2.397,30 €	●

Columna monomando para bañera con equipo de ducha.  
Free standing bath shower column with shower set.

Cartucho Cartridge: 35100-2

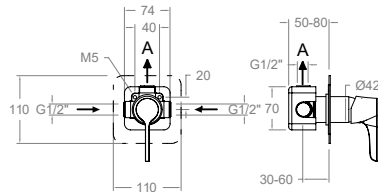

1 Vía/Way

- 911801S** 132,90 €  
 91D306101  
 XX1801+2100N-35-KU1
- 911801SNM** 236,60 €  
 91D306123  
 XX1801NM+2100N-35NM+Ku1NM
- 911801SOC** 236,60 €  
 91D306140  
 XX1801OC+2100N-35OC+Ku1OC

Monomando ducha empotrado metálico 1 vía con placa ultraslim.  
 Single lever concealed mixer 1 way with ultraslim metal plate.



XX1801	1bar	3bar	5bar
A l/min	17	26	31

Kit de ampliación - Extension set: KAIV

Cartucho Cartridge: 35100 (6689-2)

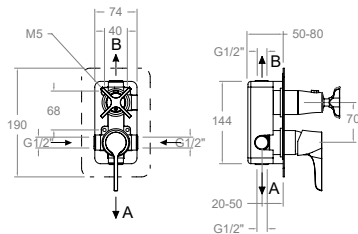

2 Vías/Ways

- 911512S** 241,40 €  
 91D306107  
 XX1502+2100N-35+215100+KU2
- 911512SNM** 430,40 €  
 91D306124  
 XX1502NM+2100N-35NM+215100NM+Ku2NM
- 911512SOC** 430,40 €  
 91D306141  
 XX1502OC+2100N-35OC+215100OC+Ku2OC

Monomando de ducha empotrado metálico 2 vías con placa ultraslim.  
 Single lever concealed mixer 2 ways with ultraslim metal plate.



XX1502	1bar	3bar	5bar
A l/min	14	24	30
B l/min	13	22	29

Kit de ampliación - Extension set: ka2v

Cartucho Cartridge: 35100 (6689-2)+4004

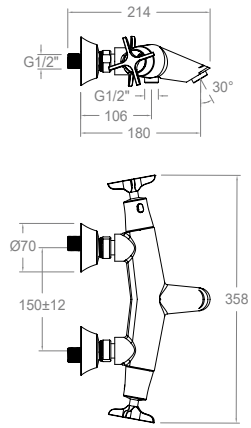

<b>913901S</b> 91C306104	405,90 €	●
<b>913901SNM</b> 91C306121	710,30 €	●
<b>913901SOC</b> 91C306138	710,30 €	●

Termostático de baño-ducha con inversor integrado.  
Thermostatic shower mixer.

Cartucho Cartridge: 1703T+4000



Adagio



MO

<b>913901MO</b> 91C306311	511,70 €	●
913901 S+3713M+3726M+2471C		
<b>913901DNM</b> 91C306312	900,60 €	●
913901SNM+3714NM+372602MNM+2475CNM		
<b>913901DOC</b> 91C306313	900,60 €	●
XX15020C+2100N-350C+2151000C+Ku20C		

Termostático de baño-ducha con equipo de ducha, inversor integrado.  
Thermostatic shower mixer with shower set.

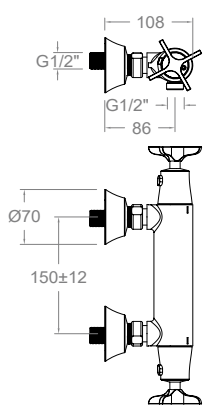

<b>913401S</b> 91D306105	301,70 €	●
<b>913401SNM</b> 91D306122	528,00 €	●
<b>913401SOC</b> 91D306139	528,00 €	●

Termostático de ducha con inversor integrado.  
Thermostatic shower mixer.

Cartucho Cartridge: 1703T+1700 1/2"



MO

<b>913401MO</b> 91D306314	407,50 €	●
913401 S+3713+3726M+2471C		
<b>913401DNM</b> 91D306315	718,30 €	●
913401SNM+3714NM+372602MNM+2475CNM		
<b>913401DOC</b> 91D306316	718,30 €	●
913401SOC+3714OC+372602MOC+2475COC		

Termostático de ducha con equipo de ducha, inversor integrado.  
Thermostatic shower mixer with shower set.





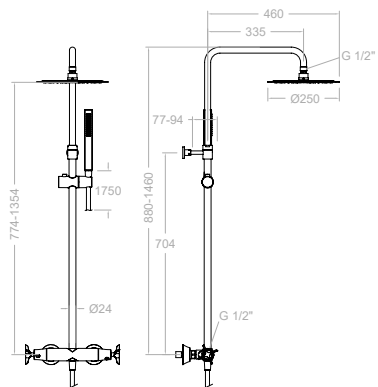

**915401RM250** 683,90 €  
 91D306317  
 911202S+DN130D+RM250+3713M+2471C ●

**915401RM250NM** 1.208,80 €  
 91D306318  
 911202SNM+DN130DNM+RM250NM+3714NM+2475CNM ●

**915401RM250OC** 1.208,80 €  
 91D306319  
 911202SOC+DN130DOC+RM250OC+3714OC+2475COC ●

Columna telescópica termostática con inversor integrado, rociador metálico Ø 250 mm.  
 Telescopic thermostatic shower column with headshower Ø 250 mm.

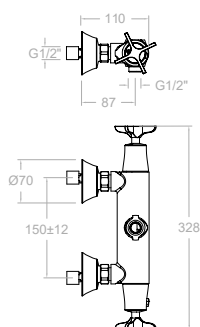

**911201S** 296,90 €  
 91D306108 ●

**911201SNM** 519,60 €  
 91D306125 ●

**911201SOC** 519,60 €  
 91D306142 ●

Grifo termostático.  
 Thermostatic mixer.

Cartucho Cartridge: 1703T + 4000

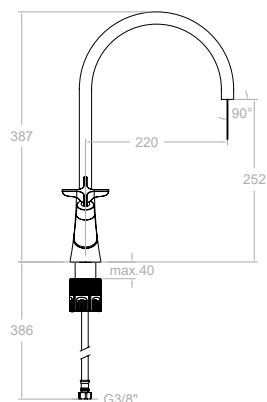

**910601** 328,00 €  
 91E306095 ●

**910601NM** 492,00 €  
 91E306112 ●

**910601OC** 574,00 €  
 91E306129 ●

Bimando de cocina.  
 Kitchen two handle mixer.



Montura Head: 1701C1/2 + 1702C1/2



# Urban Chic

Colección Collection



VER VIDEO



WATCH VIDEO





## Características Técnicas

- Cartucho monomando Ø25/Ø35 mm.
- Cartucho termostático con Sistema Hot Block de seguridad antiquemaduras y Sistema Termostop de bloqueo de la temperatura a 38°.
- Caudal a 3 bar: Lavabo y Bidé (6 l/min). Ducha (12 l/min). Baño (20 l/min).
- Nivel acústico a 3 bar: < 20 dB.
- Latón: 15 micras de espesor de níquel, 0.3 micras de cromo.
- Prestaciones de confort a nivel de fidelidad, sensibilidad y constancia en la selección de la temperatura.
- Resiste presiones estáticas ≤ 10 bar y golpes de ariete de 25 bar.
- Temperatura recomendada de agua caliente 55°C Temperatura máxima de uso 65°C. Máximo 1h a 90°C.
- Presión de uso entre 1-5 bar. Recomendada 3 bar.
- Resistente al choque térmico y químico anti-legionela.
- Sistema patentado de control de agua.
- Sistema tourbillon patentado.
- Ánodo de sacrificio anticorrosión de zinc-magnesio.
- Salida de agua cascada caudal reducido.
- Cooltouch, sistema que permite mantener la grifería templada al tacto para evitar quemaduras.

## Technical Characteristics

- Ceramic cartridge Ø25 / Ø35 mm
- Thermostatic cartridge with Hot Block System for anti-scald security and Thermostop system for temperature blocking at 38°.
- Flow at 3 bar: Washbasin. (7 l / min) Bidet (6 l / min). Shower (12 l / min). Bath (20 l / min).
- Acoustic level at 3 bar: <20 dB.
- Brass: 15 microns thick nickel, 0.3 microns chrome.
- Comfort services at the level of fidelity, sensitivity and constancy in the selection of temperature.
- Resists static pressures ≤ 10 bar and water hammers of 25 bar.
- Recommended temperature of hot water 55°C. Maximum temperature of use 65 °C. Maximum 1h at 90 °C.
- Use pressure between 1-5 bar. Recommended 3 bar.
- Resistant to thermal shock and chemical anti legionella.
- Resistant to thermal shock and chemical anti legionella.
- Patented Tourbillon System.
- Zinc-Magnesium Anti-Corrosion Sacrificial Anode.
- Cascade water outlet limited flow.
- Cooltouch, a system that allows the tap to be kept warm to the touch to avoid burns.

## Acabados disponibles Finishing availables



Cromo  
Chrome



Negro mate  
Black matte



Níquel cepillado  
Brushed nickel



Oro cepillado  
Brushed gold



Sistema Tourbillon  
Tourbillon system

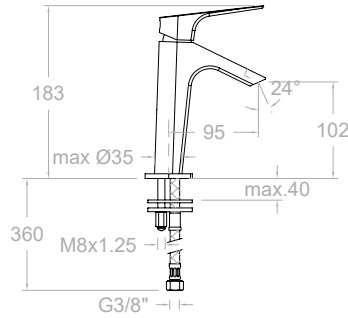

<b>210101</b> 21A302396	214,70 €	●
<b>210101NM</b> 21A303167	327,80 €	●
<b>210101NC</b> 21A303166	382,50 €	●
<b>210101OC</b> 21A303168	382,50 €	●



Monomando de lavabo salida en cascada, caudal reducido.  
Washbasin mixer with water output like a cascade.

Cartucho Cartridge: 25000-2 (4750)

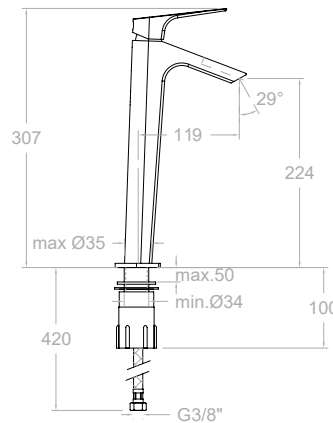

<b>211001</b> 21A302397	270,60 €	●
<b>211001NM</b> 21A303607	413,40 €	●
<b>211001NC</b> 21A303627	482,20 €	●
<b>211001OC</b> 21A303626	482,20 €	●



Monomando de lavabo xl salida en cascada, caudal reducido.  
Washbasin mixer size XL with water output like a cascade.

Cartucho Cartridge: 25000-2 (4750)

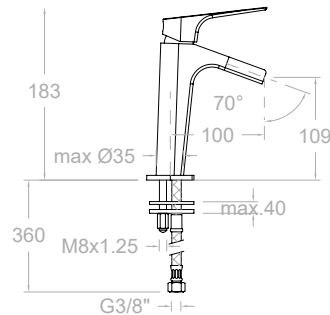

<b>213101</b> 21A302399	282,20 €	●
<b>213101NC</b> 21A303629	502,90 €	●
<b>213101OC</b> 21A303628	502,90 €	●



Monomando de lavabo con caño abierto salida cascada,  
caudal reducido.  
Washbasin mixer with cascade spout.

Cartucho Cartridge: 25000-2 (4750)

Recomendaciones Recommendations

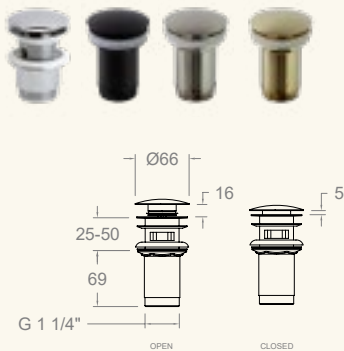

<b>1219L</b> 197106	27,40 €	●
<b>1219LNM</b> 99Z302477	41,10 €	●
<b>1219LNC</b> 99Z302476	48,30 €	●
<b>1219LOC</b> 99Z302478	48,30 €	●

Válvula metálica para desagüe sistema  
CLICK CLACK-Latón.  
Metal CLICK CLACK waste brass valve.

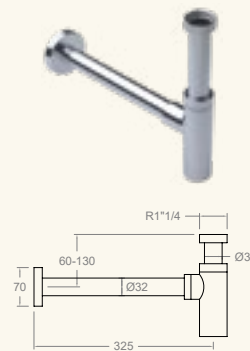

<b>3790</b> 198960	65,80 €	●
<b>3790NM</b> 99Z302332	100,90 €	●
<b>3790NC</b> 99Z302331	122,90 €	●
<b>3790OC</b> 99Z302333	122,90 €	●

Sifón.  
Bottletrap.

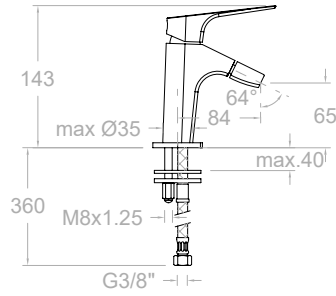

<b>210301</b> 21B302401	222,20 €	●
<b>210301NM</b> 21B303618	339,30 €	●
<b>210301NC</b> 21B303632	395,90 €	●
<b>210301OC</b> 21B303630	395,90 €	●



**Monomando para bidé salida en cascada, caudal reducido.**  
Bidet mixer with water output like a cascade.

Cartucho Cartridge: 25000-2 (4750)

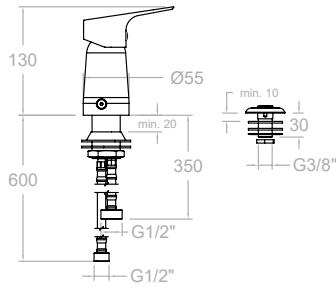

<b>SA212301</b> 21B303660	119,80 €	●
------------------------------	----------	---

**Monomando para bidé de repisa con ducha.**  
Bidet mixer deck mounted.

Cartucho Cartridge: 40100 (3388)

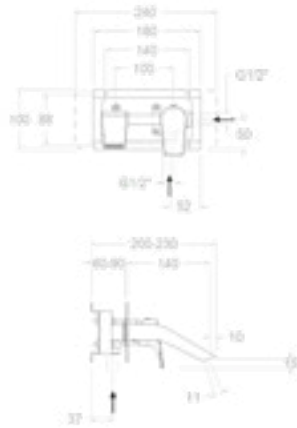

<b>212001</b> 21A302400	320,70 €	●
<b>212001NM</b> 21A303619	490,00 €	●
<b>212001NC</b> 21A303635	571,80 €	●
<b>212001OC</b> 21A303634	571,80 €	●

**Monomando de lavabo empotrado mural con salida cascada y placa metálica.**  
Wall washbasin mixer with cascade spout.

Cartucho Cartridge: 35100-2

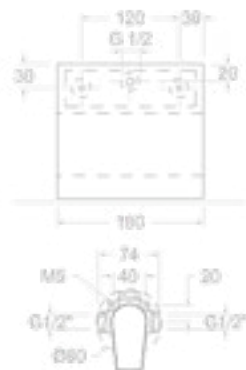

<b>211691</b> 21A302402	599,50 €	●
----------------------------	----------	---

**Monomando de lavabo empotrado mural con caño cascada extraplano.**  
Wall washbasin mixer with ultraslim cascade spout.

Cartucho Cartridge: 35100





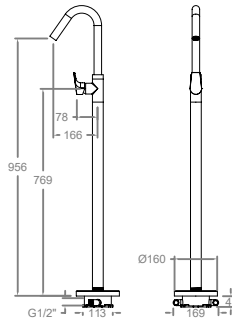

<b>217602S</b> 21A303370	952,50 €	●
<b>217602SNM</b> 21A305228	1.697,90 €	●
<b>217602SNC</b> 21A305227	1.697,90 €	●
<b>217602SOC</b> 21A305229	1.697,90 €	●



Monomando lavabo de columna.  
Free standing washbasin column.

Cartucho Cartridge: 35100-2

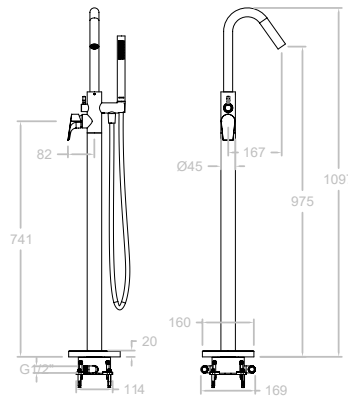

<b>218503S</b> 21C303358	1.255,60 €	●
<b>218503SNM</b> 21C305234	2.238,00 €	●
<b>218503SNC</b> 21C305233	2.238,00 €	●
<b>218503SOC</b> 21C305235	2.238,00 €	●



Columna monomando para bañera.  
Free standing bath shower column.

<b>218503MO</b> 21C303359 218503S-3713M-2471C	1.361,80 €	●
<b>218503DNM</b> 21C305231 218503SNM+3714NM+2475CNM	2.427,20 €	●
<b>218503DNC</b> 21C305230 218503SNC+3714NC+2475CNC	2.427,20 €	●
<b>218503DOC</b> 21C305232 218503SOC+3714OC+2475OC	2.427,20 €	●

Columna monomando para bañera con equipo de ducha.  
Free standing bath shower column with shower set.

Cartucho Cartridge: 35100-2

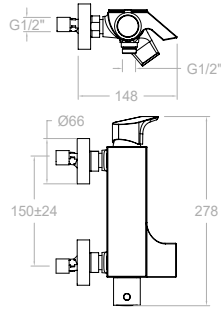

**210501S**  
21C302404

346,40 €

Monomando de baño-ducha con inversor integrado, salida cascada y repisa con vidrio de seguridad.  
Bath and shower mixer with water output like a cascade and security glass cover.



**K1**



**210501K1**  
21C302405

443,70 €

Monomando de baño-ducha con inversor integrado, salida cascada, repisa con vidrio de seguridad y equipo de ducha.  
Bath and shower mixer with water output like a cascade and security glass cover, with shower set.



210501S + 4949 K1

**K3**



**210501K3**  
21C302406

451,20 €

Monomando de baño-ducha con inversor integrado, salida cascada, repisa con vidrio de seguridad y equipo de ducha.  
Bath and shower mixer with water output like a cascade and security glass cover, with shower set.



210501S + 4950 K3

Cartucho Cartridge: 35100 + 4004

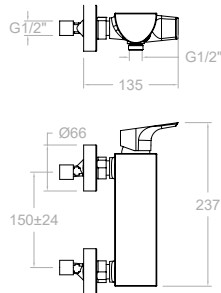

**210801S**  
21D302408

255,00 €

Monomando de ducha con repisa con vidrio de seguridad.  
Shower mixer and security glass.



**K1**



**210801K1**  
21D302409

352,40 €

Monomando de ducha con equipo de ducha y repisa con vidrio de seguridad.  
Shower mixer and security glass, with shower set.



210801S + 4949 K1

**K3**



**210801K3**  
21D302410

359,90 €

Monomando de ducha con equipo de ducha y repisa con vidrio de seguridad.  
Shower mixer and security glass, with shower set.



210801S + 4950 K3

Cartucho Cartridge: 35100-3

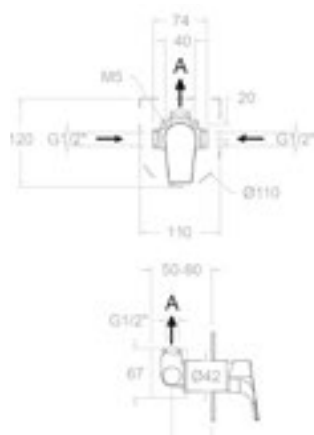

**211801S** 132,90 €  
 21D302418  
 XX1801+2100N-35+KU1

**211801SNM** 236,60 €  
 21D303620  
 XX1801NM+2100N-35NM+KU1NM

**211801SNC** 236,60 €  
 21D303637  
 XX1801NC+2100N-35NC+KU1NC

**211801SOC** 236,60 €  
 21D303636  
 XX1801OC+2100N-35OC+KU1OC



**Monomando de ducha empotrado metálico 1 vía con placa ultraslim.**  
 Single lever concealed mixer 1 way with ultraslim metal plate.

XX1801	1bar	3bar	5bar
A l/min	17	26	31

Kit de ampliación - Extension set: KA1V

1 Via/Way

Cartucho Cartridge: 35100 (6689-2)

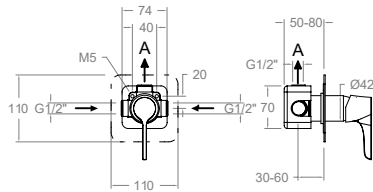

- 211502S** 241,40 €  
 21C302419  
 XX1502+2100N-35+215100+KU2
- 211502SNM** 430,40 €  
 21C303700  
 XX1502NM+2100N-35NM+215100NM+KU2NM
- 211502SNC** 430,40 €  
 21C303708  
 XX1502NC+2100N-35NC+215100NC+KU2NC
- 211502SOC** 430,40 €  
 21C303704  
 XX1502OC+2100N-35OC+215100OC+KU2OC



**Monomando de ducha empotrado metálico 2 vías con placa ultraslim.**  
 Single lever concealed mixer 2 ways with ultraslim metal plate.

XX1502	1bar	3bar	5bar
A l/min	17	24	30
B l/min	13	22	29

Kit de ampliación - Extension set: KA2V

**2 Vías/Ways**

Cartucho Cartridge: 35100 (6689-2) + 4004

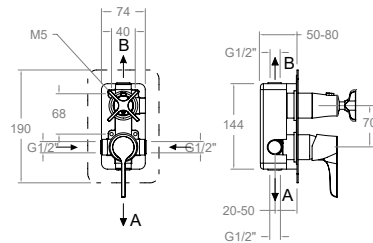

- 211503S** 283,40 €  
 21C302420  
 XX1503+2100N-35+215100+KU3
- 211503SNM** 505,10 €  
 21C303701  
 XX1503NM+2100N-35NM+215100NM+KU3NM
- 211503SNC** 505,10 €  
 21C303709  
 XX1503NC+2100N-35NC+215100NC+KU3NC
- 211503SOC** 505,10 €  
 21C303705  
 XX1503OC+2100N-35OC+215100OC+KU3OC



**3 Vías/Ways**

**Monomando de baño-ducha empotrado metálico 3 vías con placa ultraslim.**  
 Single lever concealed mixer 3 ways with ultraslim metal plate.

XX1503	1bar	3bar	5bar
A l/min	17	22	28
B l/min	13	21	26
B l/min	13	21	26

Kit de ampliación - Extension set: KA2V

Cartucho Cartridge: 35100 (6689-2) + 4003

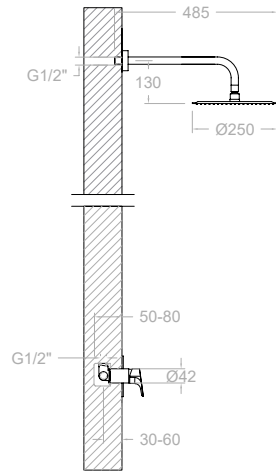

<b>K2118012</b> 21D302877 211801S+BHRM250	364,50 €	●
<b>K2118012NM</b> 21D303702 211801SNM+BHRM250NM	653,40 €	●
<b>K2118012NC</b> 21D303710 211801SNC+BHRM250NC	653,40 €	●
<b>K2118012OC</b> 21D303706 211801SOC+BHRM250OC	653,40 €	●

**Conjunto monomando empotrado metálico 1 vía con rociador metálico Ø 250 mm.**  
Shower set, single lever concealed mixer 1 way with ultraslim metal plate, metal headshower Ø 250 mm.



Cartucho Cartridge: 35100 (6689-2)

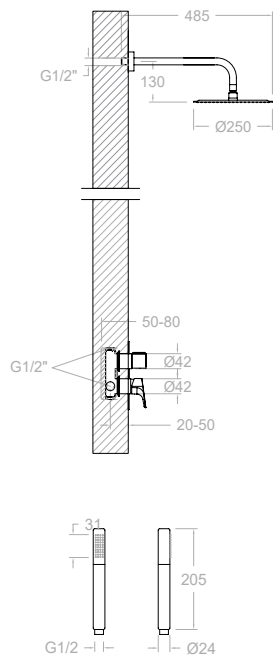

<b>K2115021</b> 21D302879 211502S+BHRM250+3713M+3796+2472C	583,70 €	●
<b>K2115021NM</b> 21C303703 211502SNM+BHRM250NM+4716MRNM+4798NM+2475CNM	1.046,10 €	●
<b>K2115021NC</b> 21C303711 211502SNC+BHRM250NC+4716MRNC+4798NC+2475CNC	1.046,10 €	●
<b>K2115021OC</b> 21C303707 211502SOC+BHRM250OC+4716MROC+4798OC+2475COC	1.046,10 €	●

**Conjunto monomando empotrado metálico 1 vía con rociador metálico ø250mm.**  
Shower set, single lever concealed mixer 1 way with ultraslim metal plate, metal headshower Ø250mm.



Cartucho Cartridge: 35100 (6689-2) - 4004



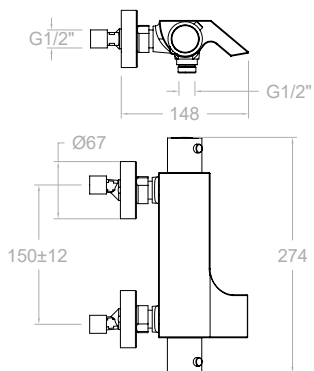

<b>213901S</b> 21C302414	463,80 €	
<b>213901SNM</b> 21C303621	826,70 €	
<b>213901SNC</b> 21C303639	826,70 €	
<b>213901SOC</b> 21C303638	826,70 €	

Termostático de baño- ducha salida cascada con inversor integrado y repisa con vidrio de seguridad.  
Thermostatic shower mixer with water output like a cascade and security glass cover.



Cartucho Cartridge: 1703T+4000



MR

<b>213901MRNM</b> 21C303779 213901SNM + 4759MRNM	1.007,10 €	
<b>213901MRNC</b> 21C303785 213901SNC+4759MRNC	1.007,10 €	
<b>213901MROC</b> 21C303782 213901SOC+4759MROC	1.007,10 €	

Termostático de baño- ducha con equipo de ducha, salida cascada, inversor integrado y repisa con vidrio de seguridad.  
Thermostatic shower mixer with water output like a cascade and security glass cover, shower set.



K3

<b>213901K3</b> 21C302417	568,70 €	
------------------------------	----------	--

Termostático de baño- ducha con equipo de ducha, salida cascada, inversor integrado y repisa con vidrio de seguridad.  
Thermostatic shower mixer with water output like a cascade and security glass cover, shower set.



213901S + 4950 K3

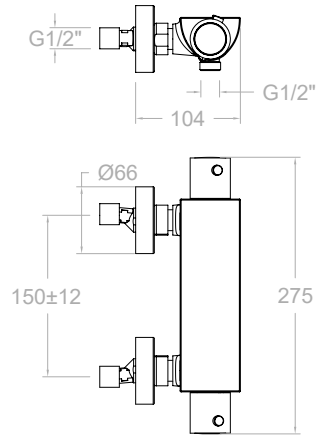

<b>213401S</b> 21D302411	377,40 €	
<b>213401SNM</b> 21D303623	672,60 €	
<b>213401SNC</b> 21D303642	672,60 €	
<b>213401SOC</b> 21D303641	672,60 €	

Termostático de ducha con repisa con vidrio de seguridad.  
Thermostatic shower mixer with security glass cover.

Cartucho Cartridge: 1703 T +1700C1/2"



MR

<b>213401MRNM</b> 21D303780 213401SNM + 4759MRNM	852,90 €	
<b>213401MRNC</b> 21D303786 213401SNC+4759MRNC	852,90 €	
<b>213401MROC</b> 21D303783 213401SOC+4759MROC	852,90 €	

Termostático de ducha con equipo de ducha, y repisa con vidrio de seguridad.  
Thermostatic shower mixer with security glass cover, shower set.



K3

<b>213401K3</b> 21D302413	482,20 €	
------------------------------	----------	--

Termostático de ducha con equipo de ducha y repisa con vidrio de seguridad.  
Thermostatic shower mixer with security glass cover, shower set.

213401S + 4950 K3

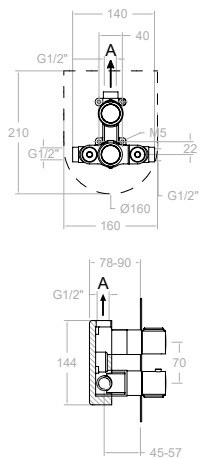

- 212411S** 228,50 €  
21D302536  
XX2411-KTU1+215100+215000
- 212411SNM** 407,40 €  
21D303625  
XX2411NM-KTU1NM+215100NM+215000NM
- 212411SNC** 407,40 €  
21D303644  
XX2411NC-KTU1NC+215100NC+215000NC
- 212411SOC** 407,40 €  
21D303643  
XX2411OC-KTU1OC+215100OC+215000OC



Termostático de ducha empotrado metálico 1 vía con placa ultraslim.  
Thermostatic concealed mixer 1 way with ultraslim metal plate.

1 Vía/Way

XX2411S	1bar	3bar	5bar
A l/min	17	26	31

Kit de ampliación - Extension set: KAET104

Cartucho Cartridge: 1703T + 1700C3/4



- 218712S** 306,80 €  
21D302544  
XX8712-KTU2+215100+215000
- 218712SNM** 541,90 €  
21D303781  
XX8712NM-KTU2NM+215100NM+215000NM
- 218712SNC** 541,90 €  
21D303787  
XX8712NC-KTU2NC+215100NC+215000NC
- 218712SOC** 541,90 €  
21D303784  
XX8712OC-KTU2OC+215100OC+215000OC



Termostático de ducha empotrado metálico 2 vías con placa ultraslim.  
Thermostatic concealed mixer 2 ways with ultraslim metal plate.

2 Vías/Ways

XX8712S	1bar	3bar	5bar
A l/min	17	26	31
B l/min	13	22	28

Kit de ampliación - Extension set: KAET103

Cartucho Cartridge: 1703T + 4000

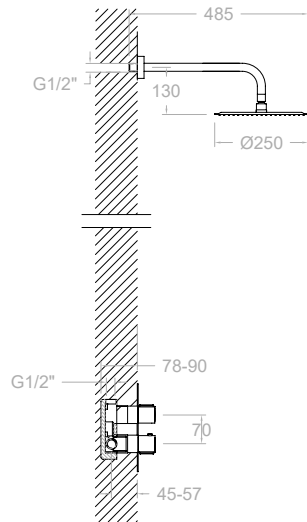

<b>K2124012</b> 21D302752 212411S-BHRM250	460,20 €	●
<b>K2124012NM</b> 21D305237 212411SNM-BHRM250NM	824,20 €	●
<b>K2124012NC</b> 21D305236 212411SNC-BHRM250NC	824,20 €	●
<b>K2124012OC</b> 21D305238 212411SOC-BHRM250OC	824,20 €	●

**Conjunto termostático empotrado metálico 1 vía con rociador metálico Ø 250 mm.**  
Shower set, thermostatic concealed mixer 1 way with ultraslim metal plate, metal headshower Ø 250 mm.

Cartucho Cartridge: 1703 T + 1700C3/4

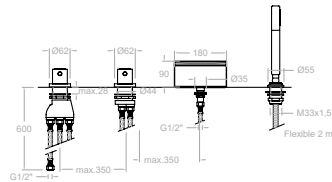

<b>213303TM</b> 21C302429	1403,60 €	●
------------------------------	-----------	---

**Termostático de repisa para bañera con caño cascada, inversor integrado y equipo de ducha metálico.**  
Thermostatic deck-mounted bathtub mixer, cascade spout and metal shower set.

Cartucho Cartridge: 1700 TE + 4000

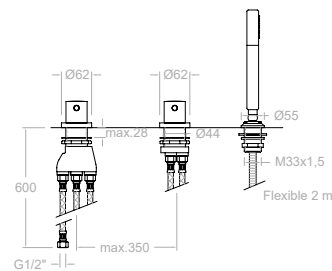

<b>213303TSCAM</b> 21C302430	640,80 €	●
---------------------------------	----------	---

**Termostático de repisa para bañera con inversor integrado y equipo de ducha metálico.**  
Thermostatic deck-mounted bathtub mixer with metal shower set.

Cartucho Cartridge: 1700 TE + 4000



Recomendaciones Recommendations

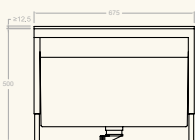

<b>100502</b> AAZ302174	699,00 €	●
----------------------------	----------	---

**Repisa extraíble con depósito para el agua de conjunto baño.**  
Mounting block with heightadjustable panel and tube box for bath deck (included).

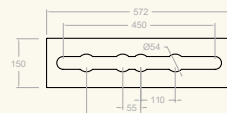

<b>100502R</b> AAZ302626	204,70 €	●
-----------------------------	----------	---

**Repisa soporte para conjunto baño.**  
Mounting plate for bath deck.



**SK2187011** 437,00 €  
 21D302763  
 218712S+3713M+3796+2472C

+

**RIKS** 911,00 €  
 99Z300707

Bimando de lavabo para repisa. Caño giratorio de 170mm.  
 Washbasin 3 hole mixer spout 170mm.



**SK2187011** 437,00 €  
 21D302763  
 218712S+3713M+3796+2472C

+

**RR** 746,40 €  
 99Z300711

Bimando de lavabo para repisa. Caño giratorio de 170mm.  
 Washbasin 3 hole mixer spout 170mm.



**SK2187011** 437,00 €  
 21D302763  
 218712S+3713M+3796+2472C

+

**RIR** 673,00 €  
 99Z300702

Bimando de lavabo para repisa. Caño giratorio de 170mm.  
 Washbasin 3 hole mixer spout 170mm.





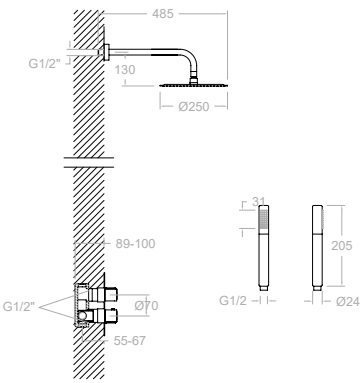

**K2187011** 649,00 €  
 21D302757  
 218712S+BHRM250+3713M+3796+2472C

**K2187011NM** 1.157,50 €  
 21D305240  
 218712SNM+BHRM250NM+4716MRNM+4798NM+2475CNM

Conjunto termostático empotrado metálico 2 vías con soporte, toma de agua, teleducha y rociador metálico ø 250 mm.

**K2187011NC** 1.157,50 €  
 21D305239  
 218712SNC+BHRM250NC+4716 RNC+4798NC+2475CNC

**K2187011OC** 1.157,50 €  
 21D305241  
 218712SOC+BHRM250OC+4716 ROC+4798OC+2475COC

Shower set, thermostatic concealed mixer 2 ways with ultraslim metal plate, water outlet, metal handshower, metal headshower Ø 250 mm.



Cartucho Cartridge: 1703T + 4000

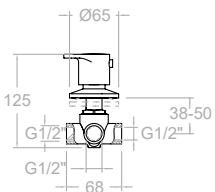

**9437** 157,50 €  
 94F305436

**9437NM** 275,60 €  
 94F305437

**9437NC** 275,60 €  
 94F305439

**9437OC** 275,60 €  
 94F305438

Inversor de 3 vías, mural.  
 3 way diverter.

Cartucho Cartridge: 1000 I

**94071/2X1** 94,90 €  
 94F305427

**94071/2X1NM** 166,00 €  
 94F305429

**94071/2X1NC** 166,00 €  
 94F305432

**94071/2X1OC** 166,00 €  
 94F305430

Llave de paso de 1/2\"/>
 1/2" angle valve.

Montura Head: 5000

**94073/4X1** 124,60 €  
 94F305428

**94073/4X1NM** 217,90 €  
 94F305433

**94073/4X1NC** 217,90 €  
 94F305435

**94073/4X1OC** 217,90 €  
 94F305434

Llave de paso de 3/4\"/>
 3/4" angle valve.

Montura Head: 6000

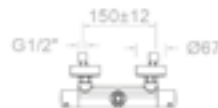
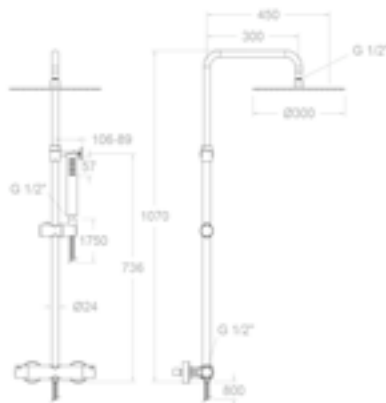
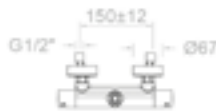
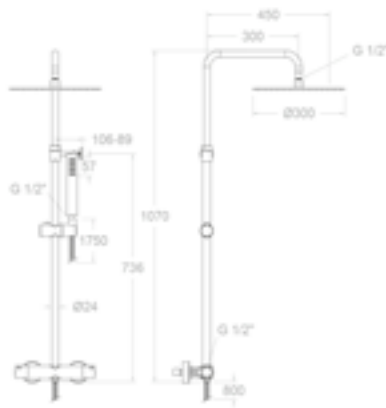

**215401RK300N** 987,30 €  
21D302428

**215401RK300NM** 1.760,10 €  
21D305221

**215401RK300NC** 1.760,10 €  
21D305220

**215401RK300OC** 1.760,10 €  
21D305222

Columna telescópica termostática con inversor integrado, rociador cuadrado metálico Ø 300 mm.  
Telescopic thermostatic shower column with square metal headshower Ø 300 mm.

**211201S** 320,70 €  
21D302426

**211201SNM** 571,80 €  
21D305211

**211201SNC** 571,80 €  
21D305210

**211201SOC** 571,80 €  
21D305212

Cuerpo termostático de columna.  
Thermostatic body.

Cartucho Cartridge: 1703T + 4000

**215401RM300** 942,20 €  
21D302427

**215401RM300NM** 1.679,60 €  
21D305225

**215401RM300NC** 1.679,60 €  
21D305223

**215401RM300OC** 1.679,60 €  
21D305226

Columna telescópica termostática con inversor integrado, rociador metálico Ø 300 mm.  
Telescopic thermostatic shower column with round headshower Ø 300 mm.

Cartucho Cartridge: 1703T + 4000

**211201S** 320,70 €  
21D302426

**211201SNM** 571,80 €  
21D305211

**211201SNC** 571,80 €  
21D305210

**211201SOC** 571,80 €  
21D305212

Cuerpo termostático de columna.  
Thermostatic body.



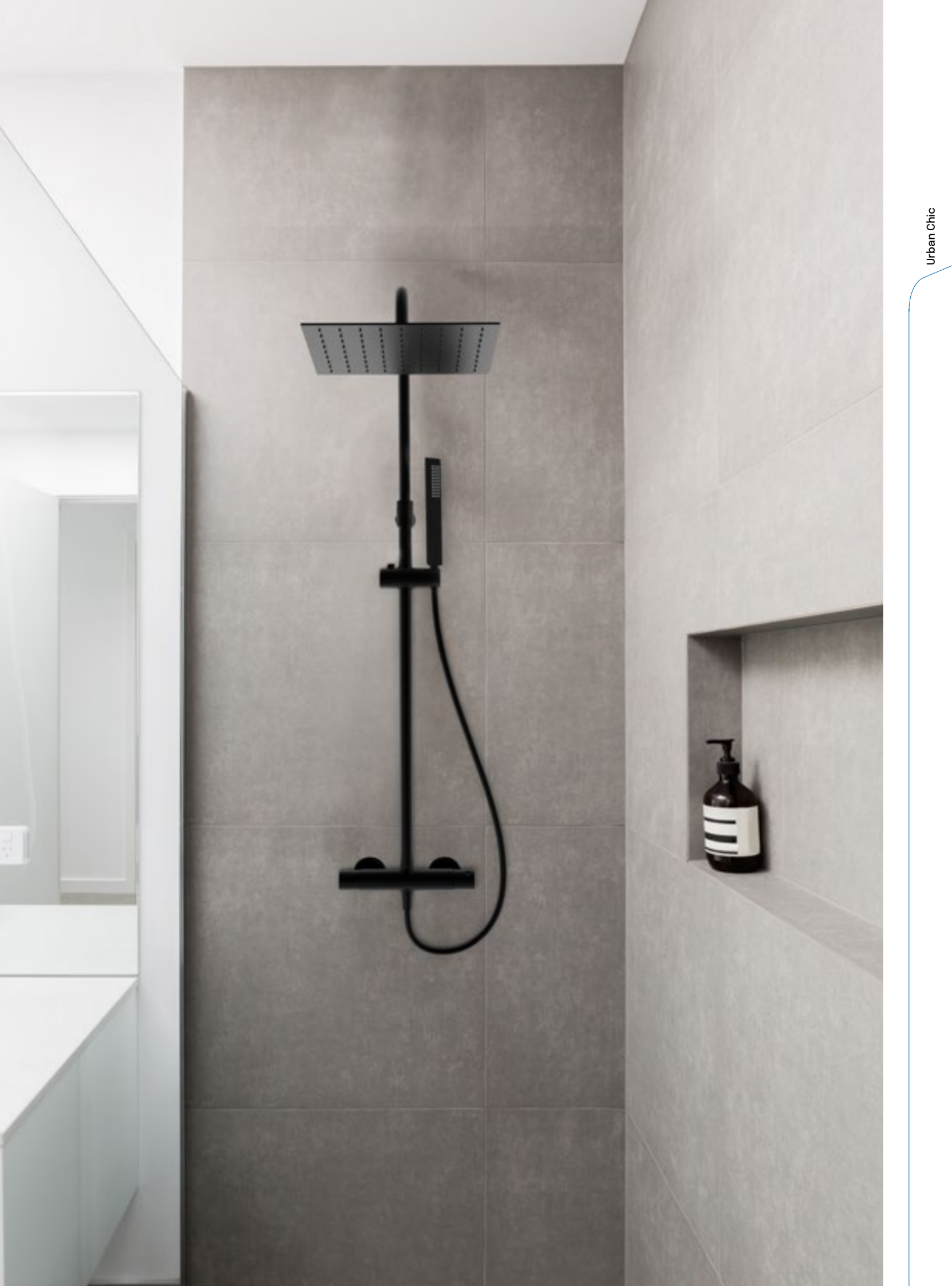

# Alexia

Colección Collection



## Características Técnicas

- Cartucho cerámico Ø35 mm.
- Cartuchos monomando con Sistema Termostop Block de limitación de la temperatura máxima del agua caliente y Sistema de ahorro de agua S2 (disponible C2 en algunos modelos) mediante la apertura de la manecilla en dos fases.
- Cartucho termostático con Sistema Hot Block de seguridad antiquemaduras y Sistema Termostop de bloqueo de la temperatura a 38°C.
- Caudal a 3 bar: Lavabo y Fregadero (de 11 l/min). Bidé (5 l/min). Ducha (12 l/min). Baño (20 l/min).
- Nivel acústico a 3 bar: < 20 dB.
- Cromado latón: 15 micras de espesor de níquel, 0.3 micras de cromo.
- Prestaciones de confort a nivel de fidelidad, sensibilidad y constancia en la selección de la temperatura.
- Resiste presiones estáticas ≤ 10 bar y golpes de ariete de 25 bar.
- Temperatura recomendada de agua caliente 55°C. Temperatura máxima de uso 65°C. Máximo 1h a 90°C.
- Presión de uso entre 1-5 bar. Recomendada 3 bar.
- Resistente al choque térmico y químico anti legionela.
- Ánodo de sacrificio anticorrosión de zinc-magnesio
- Cooltouch, sistema que permite mantener la grifería templada al tacto para evitar quemaduras.

## Technical Characteristics

- Ceramic cartridge Ø35 mm.
- Single lever cartridges with Termostop Block System for limiting the maximum hot water temperature and S2 water Saving System (C2 available on some models) by opening the handle in two phases.
- Thermostatic cartridge with hot block anti-burn Safety System and Termostop Temperature blocking System at 38 ° C.
- Flow rate at 3 bar: Washbasin and sink (11l/min). Bidet (5l/min). Shower (12l/min). Bathroom (20l/min).
- Acoustic level at 3 bar: <20 dB.
- Chromed brass: 15 microns thick nickel, 0.3 microns chrome.
- Comfort services at the level of fidelity, sensitivity and constancy in the selection of temperature.
- Resists static pressures ≤ 10 bar and water hammers of 25 bar.
- Recommended temperature of hot water 55°C. Maximum temperature of use 65 ° C. Maximum 1h at 90 ° C.
- Use pressure between 1-5 bar. Recommended 3 bar.
- Resistant to thermal shock and chemical anti legionella.
- Zinc-magnesium anti-corrosion sacrificial anode.
- Cooltouch, a system that keeps the faucet warm to the touch to avoid burns.

## Acabados disponibles Finishing availables



● Cromo  
Chrome



● Negro mate  
Black matte



● Níquel cepillado  
Brushed nickel



● Oro cepillado  
Brushed gold







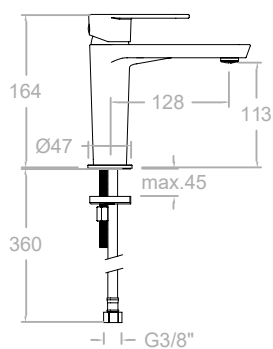

**3604** 114,10 €  
36A300352 ●



**3604NM** 177,70 €  
36A300617 ●

**3604NC** 207,30 €  
36A302177 ●

**3604OC** 207,30 €  
36A302281 ●

Monomando de lavabo (M).  
High washbasin mixer (M).



Cartucho Cartridge: 35100-3



**Ahorro de energía**  
**Apertura en frío**

Energy saving  
Cold opening



**360403** 119,40 €  
36A301875 ●

**360403NM** 182,20 €  
36A305380 ●

Monomando de lavabo, apertura en frío (M).  
Washbasin mixer, cold opening (M).



Cartucho Cartridge: 35300-3

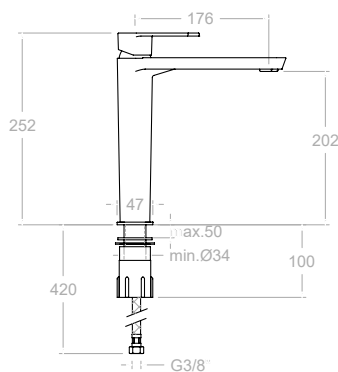

**3610** 147,40 €  
36A300353 ●

**3610NM** 229,50 €  
36A300620 ●

Monomando de lavabo (L).  
High washbasin mixer (L).



Cartucho Cartridge: 35100-3

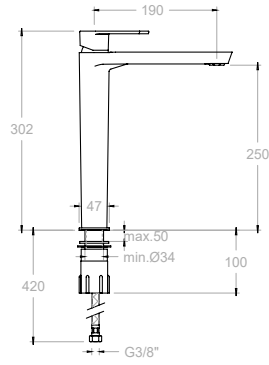

<b>3602</b> 36A300506	187,90 €	●
<b>3602NM</b> 36A302271	292,70 €	●
<b>3602NC</b> 36A302238	341,40 €	●
<b>3602OC</b> 36A302273	341,40 €	●

**Monomando de lavabo (XL).**  
High washbasin mixer (XL).



Cartucho Cartridge: 35100-3



**Ahorro de energía**  
**Apertura en frío**

Energy saving  
Cold opening



<b>360203</b> 36A305388	218,80 €	●
----------------------------	----------	---

**Monomando de lavabo, apertura en frío (XL).**  
Washbasin mixer, cold opening (XL).



Cartucho Cartridge: 35300-3

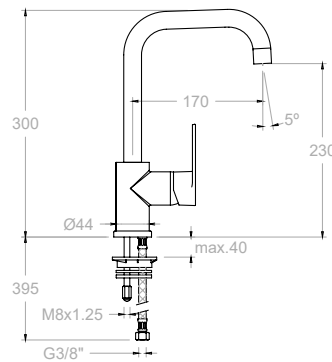

<b>3611</b> 36A300354	107,70 €	●
--------------------------	----------	---

**Monomando de lavabo con caño giratorio.**  
Washbasin mixer with swivel spout.

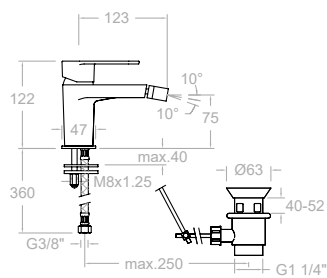

Cartucho Cartridge: 35200 (6689C2)

**360302**

36B303692

93,40 €

**3603NM**

36B302276

145,50 €

**3603NC**

36B302275

169,70 €

**3603OC**

36B302277

169,70 €

Monomando de bidé.

Bidet mixer.

**360302VA9065**

36B303690

104,50 €

Monomando de bidé con válvula automática 1 1/4".

Bidet Mixer with pop-up waste 1 1/4".

Ref. 9065 ABS

**360302VA1169**

36B303689

112,90 €

Monomando de bidé con válvula automática 1 1/4".

Bidet Mixer with pop-up waste 1 1/4".

Ref. 1169 INOX

Cartucho Cartridge: 35100-3

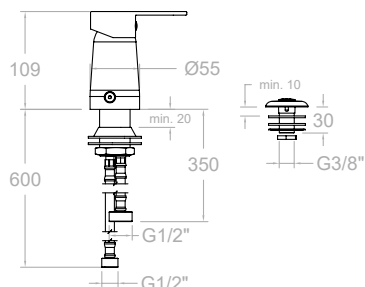
**SA362302**

36B303661

111,20 €

**SA362302NM**

36B306753

166,90 €

Monomando para bidé de repisa con ducha.

Deck mounted bidet.

Cartucho Cartridge: 40100 (3388)



Venta en el  
Continente Americano  
Available in North, Central  
& South America

## Recomendaciones Recommendations

**1219L**

197106

27,40 €

**1219LNM**

99Z302477

41,10 €

**1219LNC**

99Z302476

48,30 €

**1219LOC**

99Z302478

48,30 €

Válvula metálica para desagüe  
sistema CLICK CLACK-Latón.  
Metal CLICK CLACK waste brass valve.

**121602P**

AAZ303592

16,50 €

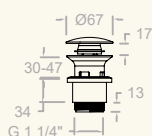
Sistema CLICK CLACK lavabo  
en PVC-Inox.CLICK CLACK wash PVC-Inox  
system.**3790**

198960

65,80 €

**3790NM**

99Z302332

100,90 €

**3790NC**

99Z302331

122,90 €

**3790OC**

99Z302333

122,90 €

Sifón.  
Bottletrap.

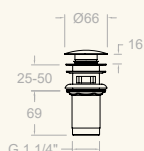
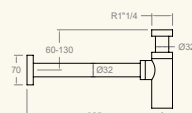



KIT DE AMPLIACIÓN - EXTENSION SET: KAB

- XX20CT+3600N-35-CLET24-R 21H+RB21S
- XX20CTNM+3600N-35NM+CLET24 M+RB21HNM+RB21SNM
- XX20CTNC+3600N-35NC+CLET24NC RB21HNC+RB21SNC
- XX20CTOC+3600N-35OC+CLET24OC+RB21HOC+RB21SOC

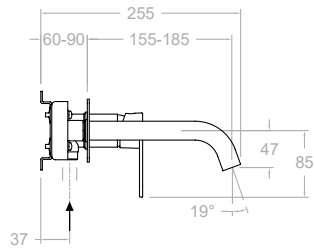
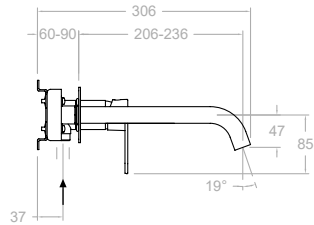
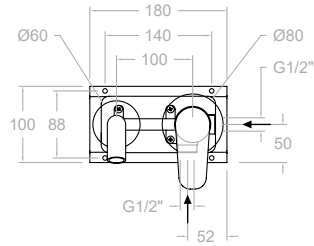

<b>362103</b> 36A301455	242,70 €	●
<b>362103NM</b> 36A302124	377,90 €	●
<b>362103NC</b> 36A302306	440,70 €	●
<b>362103OC</b> 36A302307	440,70 €	●

Monomando de lavabo empotrado mural con caño de 24 cm.  
Concealed washbasin mixer with 24 cm spout.

<b>362101</b> 36A300359	233,50 €	●
<b>362101NM</b> 36A302899	363,60 €	●
<b>362101NC</b> 36A302902	424,30 €	●
<b>362101OC</b> 36A302900	424,30 €	●

Monomando de lavabo empotrado mural con caño de 19 cm.  
Concealed washbasin mixer with 19 cm spout.

Cartucho Cartridge: 35100-2



KIT DE AMPLIACIÓN - EXTENSION SET: KAB

- XX20CF+3600N-35-CLEA+RB21H+KXB20
- XX20CFNM+3600N-35NM+CLEANM+KXB20NM
- XX20CFNC+3600N-35NC+CLEANC+KXB20NC
- XX20CFOC+3600N-35OC+CLEAOC+KXB20OC

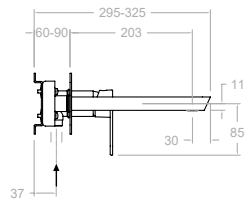
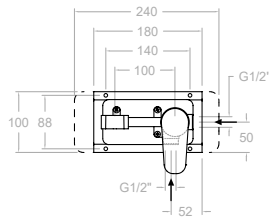

<b>3620</b> 36A300588	299,30 €	●
<b>3620NM</b> 36A302303	466,20 €	●
<b>3620NC</b> 36A302302	544,00 €	●
<b>3620OC</b> 36A302304	544,00 €	●

Monomando de lavabo empotrado mural con placa.  
Single lever concealed washbasin with plate.

Cartucho Cartridge: 35100-2

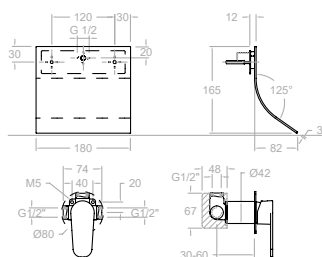

<b>36169</b> 36A300912	547,30 €	●
---------------------------	----------	---

Monomando de lavabo empotrado mural con caño cascada extraplano.  
Wall washbasin mixer with ultraslim cascade spout.

Cartucho Cartridge: 35100



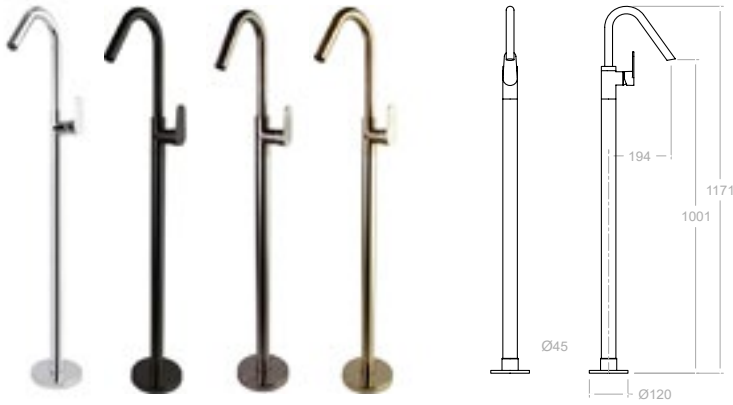

<b>367602S</b> 36A303368	865,80 €	●
<b>367602SNM</b> 36A303582	1.573,20 €	●
<b>367602SNC</b> 36A303608	1.573,20 €	●
<b>367602SOC</b> 36A303862	1.573,20 €	●

Monomando lavabo de columna.  
Washbasin column mixer.



Cartucho Cartridge: 35001-2



<b>368503S</b> 36C303354	1.176,70 €	●
<b>368503SNM</b> 36C303375	2.138,00 €	●
<b>368503SNC</b> 36C303377	2.138,00 €	●
<b>368503SOC</b> 36C303376	2.138,00 €	●

Columna monomando para bañera.  
Free standing bath shower column.



<b>368503MO</b> 36C303355 368503S+3713M+2471C	1.239,80 €	●
<b>368503DNM</b> 36C303380 368503SNM+3714NM+2475CNM	2.251,40 €	●
<b>368503DNC</b> 36C303382 368503SNC+3714NC+2475CNC	2.251,40 €	●
<b>368503DOC</b> 36C303381 368503SOC+3714OC+2475COC	2.251,40 €	●

Columna monomando para bañera con equipo de ducha.  
Free standing bath shower column with shower set.

Cartucho Cartridge: 35001-2

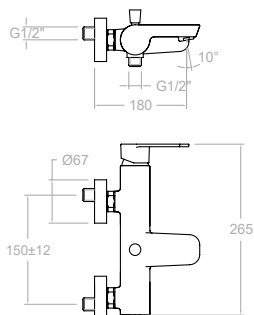

**3605S**  
36C300356

141,10 €



**360501SNM**  
36C303662

211,70 €



**360501SNC**  
36C307765

246,90 €



**360501SOC**  
36C307764

246,90 €



Monomando de baño-ducha sin equipo de ducha.  
Bath and shower mixer without shower set.

T1



**3605TR**  
36C300628

240,90 €

Conjunto monomando de baño-ducha con equipo de ducha.  
Bath and shower mixer with shower set.

3605S+2877TR+3726M+2472C



TR



**3605T1**  
36C300627

185,00 €

Conjunto monomando de baño-ducha con equipo de ducha.  
Bath and shower mixer with shower set.

3605 S + 3520 T1 + 3726M + 2472C



Acabados especiales disponibles en Junio  
Special finishings available in June

Cartucho Cartridge: 35100 (6689-2)



BT

**360501BTNM**  
36C303666

360,80 €

Conjunto monomando de baño-ducha con equipo de ducha.  
Bath and shower mixer with shower set.

360501SNM + 2876BTNM + 372602NM + 2475CNM



Q3



**360501Q3NC**  
36C307766

408,90 €



360501SNC+4914Q3NC+372602NC+2475CNC



**360501Q3OC**  
36C307767

408,90 €



360501SOC+4914Q3OC+372602OC+2475COC



Conjunto monomando de baño-ducha con equipo de ducha.  
Bath and shower mixer with shower set.



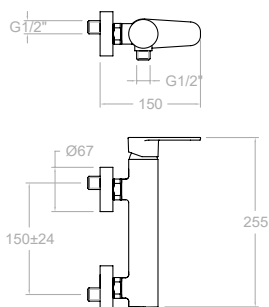

**3608S**  
36D300357

114,10 €



**360801SNM**  
36D303663

171,20 €



**360801SNC**  
36D307761

199,70 €

N



**360801SOC**  
36D307760

199,70 €

N



Monomando de ducha sin equipo de ducha.  
Shower mixer without shower set.

T1



**3608TR**  
36D300632

213,90 €

Conjunto monomando de baño-z ducha con equipo de ducha.  
Bath and shower mixer with shower set.

3608 S + 3520 TR + 3726M + 2472C



TR



**3608T1**  
36D300631

158,00 €

Conjunto monomando de ducha con equipo de ducha.  
Shower mixer with shower set.

3608 S + 3520 T1 + 3726M + 2472C



Acabados especiales  
disponibles en Junio  
Special finishings  
available in June

Cartucho Cartridge: 35100-3



BT

**360801BTNM**  
36C303668

320,30 €

Conjunto monomando de ducha con equipo de ducha.  
Shower mixer with shower set.

360801SNM + 2876BTNM + 372602NM + 2475CNM



Q3



**360801Q3NC**  
36D307762

361,70 €

N

360801SNC+4914Q3NC+372602NC+2475CNC



**360801Q3OC**  
36D307763

361,70 €

N

360801SOC+4914Q3OC+372602OC+2475COC



Conjunto monomando de ducha con equipo de ducha.  
Shower mixer with shower set.

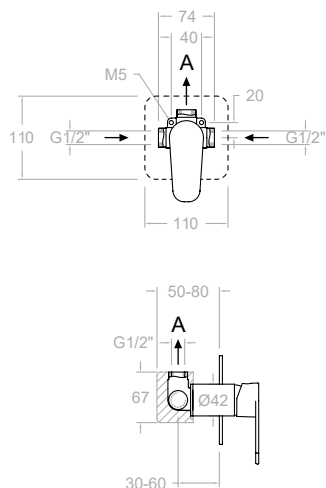

1 Vía/Way

- 361801S** 102,30 €  
36D300365  
XX1801+3600N-35+KX1
- 361801SNM** 185,70 €  
36C302298  
XX1801NM+3600N-35NM+KX1NM
- 361801SNC** 185,70 €  
36C302297  
XX1801NC+3600N-35NC+KX1NC
- 361801SOC** 185,70 €  
36C302300  
XX1801OC+3600N-35OC+KX1OC

Monomando de ducha empotrado 1 vía con placa metálica.  
Single lever concealed mixer 1 way with ultraslim metallic plate.

XX1801	1bar	3bar	5bar
A l/min	17	26	34

Kit de ampliación - Extension set: KA1V



Cartucho Cartridge: 35100 (6689-2)

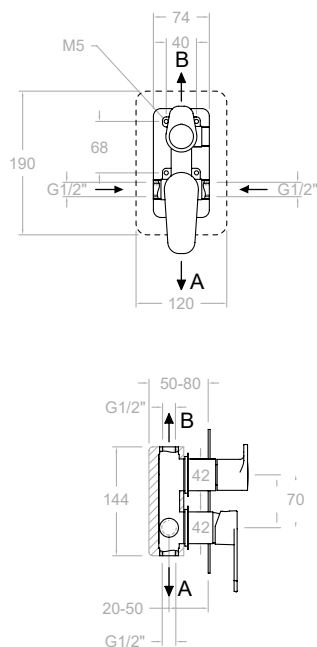

2 Vías/Ways

- 361502S** 183,60 €  
36C300363  
XX1502+3600N-35+365100+KX2
- 361502SNM** 275,40 €  
36C302116  
XX1502NM+3600N-35NM+365100NM+KX2NM
- 361502SNC** 333,90 €  
36C302291  
XX1502NC+3600N-35NC+365100NC+KX2NC
- 361502SOC** 333,90 €  
36C302292  
XX1502OC+3600N-35OC+365100OC+KX2OC

Monomando de ducha empotrado 2 vías con placa metálica.  
Single lever concealed mixer 2 ways with ultraslim metallic plate.

XX1502	1bar	3bar	5bar
A l/min	14	24	30
B l/min	13	22	29

Kit de ampliación - Extension set: ka2v



Cartucho Cartridge: 35100 (6689-2) + 4004



### 3 Vías/Ways

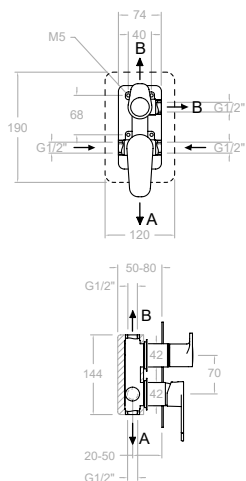

Cartucho Cartridge: 35100 (6689-2) + 4003

**361503S** 217,30 €

36C300360

XX1503+3600N-35+365100+KX3



**361503SNM** 326,00 €

36C302149

XX1503NM+3600N-35NM+365100NM+KX2NM



**361503SNC** 394,80 €

36C302294

XX1503NC+3600N-35NC+365100NC+KX2NC



**361503SOC** 394,80 €

36C302295

XX1503OC+3600N-35OC+365100OC+KX2OC



Monomando de ducha empotrado 3 vías con placa metálica.  
Single lever concealed mixer 3 ways with ultraslim metallic plate.

XX1503	1bar	3bar	5bar
A l/min	14	24	30
B l/min	13	22	29
B l/min	13	21	26

Kit de ampliación - Extension set: KA3V

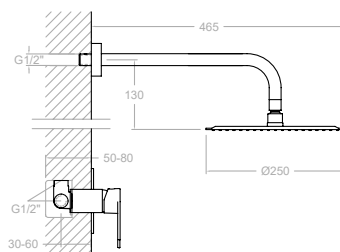

**K3618012** 333,90 €

36D301352

361801S + BHRM250



**K3618012NM** 500,90 €

36D302887

361801SNM + BHRM250NM



**K3618012NC** 602,60 €

36D302889

361801SNC + BHRM250NC



**K3618012OC** 602,60 €

36D302888

361801SOC + BHRM250OC



Conjunto monomando empotrado 1 vía con rociador metálico ø 250 mm.

Shower set with concealed single lever 1 way mixer, water outlet, metallic headshower ø 250 mm.

Cartucho Cartridge: 35100 (6689-2)

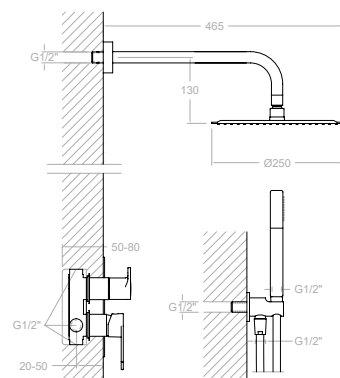

**K3615021** 525,80 €

36C301354

361502S+BHRM250+3713M+3796+2472C



**K3615021NM** 789,00 €

36D302893

361502SNM+BHRM250NM+3714NM+3796NM+2475CNC



**K3615021NC** 949,60 €

36D302895

361502SNC+BHRM250NC+3714NC+3796NC+2475CNC



**K3615021OC** 949,60 €

36D302894

361502SOC+BHRM250OC+3714OC+3796OC+2475COC



Conjunto monomando empotrado 2 vías con soporte, toma de agua, teleducha y rociador metálico ø 250 mm.

Shower set with concealed single lever 2 ways mixer, water outlet, handshower, metallic headshower ø 250 mm.

Cartucho Cartridge: 35100 (6689-2)+4004

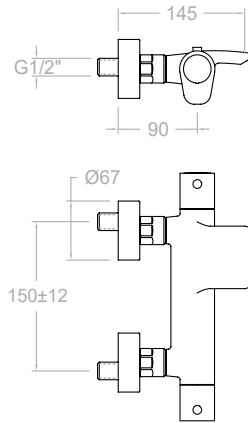

<b>363901S</b> 36C300369	251,90 €	●
<b>363901SNM</b> 36C302315	457,90 €	●
<b>363901SNC</b> 36C302314	457,90 €	●
<b>363901SOC</b> 36C302316	457,90 €	●

Termostático de baño-ducha salida cascada, sin equipo de ducha.  
Thermostatic bath shower mixer with cascade stream, without shower set.

Cartucho Cartridge: 1701 T + 4001



TR

<b>363901TR</b> 36C300641	351,70 €	●
------------------------------	----------	---

Termostático de baño-ducha salida cascada, con equipo de ducha.  
Bathtub thermostatic with cascade stream, with shower set.

363901 S + 5813TR



T1

<b>363901T1</b> 36C300640	295,80 €	●
------------------------------	----------	---

Termostático de baño-ducha salida cascada, con equipo de ducha.  
Bathtub thermostatic with cascade stream, with shower set.

363901 S + 3520 T1+3726M+2472C



D

<b>363901DNM</b> 36C302667 363901SNM+3714NM+372602NM+2475CNM	607,20 €	●
<b>363901DNC</b> 36C302666 363901SNC+3714NC+372602NC+2475CNC	607,20 €	●
<b>363901DOC</b> 36C302669 363901SOC+3714OC+372602OC+2475COC	607,20 €	●

Termostático de baño-ducha salida cascada, con equipo de ducha.  
Bathtub thermostatic with cascade stream, with shower set.



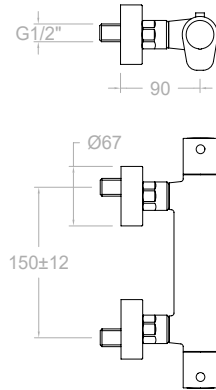

<b>363402S</b> 36D306697	220,80 €	●
<b>363402SNM</b> 36D306702	401,30 €	●
<b>363402SNC</b> 36D306703	401,30 €	●
<b>363402SOC</b> 36D306704	401,30 €	●

Termostático de ducha, sin equipo de ducha  
Thermostatic shower mixer without shower set.

Cartucho Cartridge: 1701T + 1700C 1/2"



TR

<b>363402TR</b> 36D306706	320,60 €	●
------------------------------	----------	---

Termostático de ducha, con equipo de ducha.  
Thermostatic shower mixer, with shower set.

3634 S + 5813TR



T1

<b>363402T1</b> 36D306705	264,70 €	●
------------------------------	----------	---

Termostático de ducha, con equipo de ducha.  
Thermostatic shower mixer, with shower set.

3634 S + 3520 T1 + 3726M + 2472C



D

<b>363402DNM</b> 36D306698 363402SNM+3714NM+372602NM+2475CNM	550,50 €	●
<b>363402DNC</b> 36D306699 363402SNC+3714NC+372602NC+2475CNC	550,50 €	●
<b>363402DOC</b> 36D306701 363402SOC+3714OC+372602OC+2475COC	550,50 €	●

Termostático de ducha, con equipo de ducha.  
Thermostatic shower mixer, with shower set.



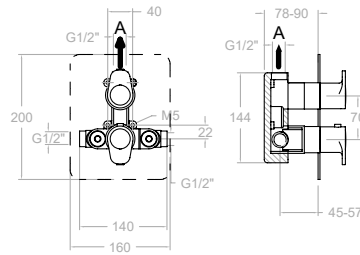

- 362411S** 182,70 €  
36D302528  
XX2411-KTX1+365000+365100
- 362411SNM** 332,30 €  
36D302468  
XX2411NM+KTX1NM+365000NM+365100NM
- 362411SNC** 332,30 €  
36D302467  
XX2401NC+KTX1NC+365000NC+365100NC
- 362411SOC** 332,30 €  
36D302469  
XX2411OC+KTX1OC+365000OC+365100OC



**1 Vía/Way**

Termostático de ducha empotrado 1 vía con placa metálica.  
Thermostatic concealed mixer 1 way with ultraslim metallic plate.

XX2411S	1bar	3bar	5bar
A l/min	17	26	31
Kit de ampliación - Extension set: KAETI04			

Cartucho Cartridge: 1703T + 1700C3/4"

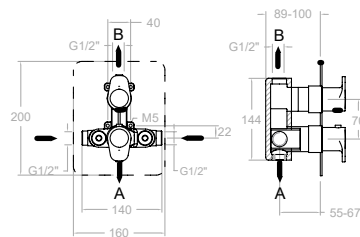

- 368712S** 255,90 €  
36D302537  
XX8712-KTX2+365000+365100
- 368712SNM** 464,70 €  
36D302473  
XX8712NM+KTX2NM+365000NM+365100NM
- 368712SNC** 464,70 €  
36D302472  
XX8712NC+KTX2NC+365000NC+365100NC
- 368712SOC** 464,70 €  
36D302474  
XX8712OC+KTX2OC+365000OC+365100OC



**2 Vías/Ways**

Termostático de ducha empotrado 2 vías con placa metálica extraplana.  
Thermostatic concealed mixer 2 ways with ultraslim metallic plate.

XX8712	1bar	3bar	5bar
A l/min	14	24	30
B l/min	13	22	28
Kit de ampliación - Extension set: KAETI03			

Cartucho Cartridge: 1703T + 4000

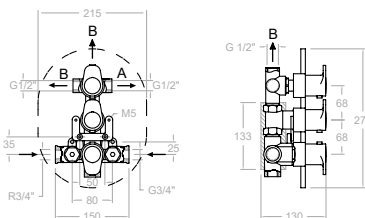

- 3627S** 720,70 €  
36D300814  
ETDI + 3651 + 3655 + 3653 + K23



Termostático de ducha empotrado 3 vías con placa metálica extraplana.  
Thermostatic concealed mixer 3 ways with ultraslim metallic plate.

ETDI	CARTUCHO GRAN CAUDAL 1700 TE		
A (Baño)	1bar	3bar	5bar
	14	24	30
B (Baño)	13	22	28
Kit de ampliación - Extension set: KAETDI			

Cartucho Cartridge: 1700TE + 1700C3/4" + 1000I



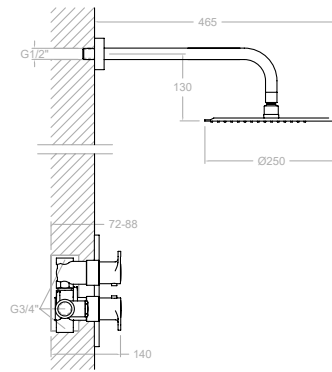

<b>K3624012</b> 36D302750 362411S-BHRM250	414,50 €	●
<b>K3624012NM</b> 36D305483 362411SNM-BHRM250NM	749,10 €	●
<b>K362401NC</b> 36D305485 362411SNC-BHRM250NC	749,10 €	●
<b>K3624012OC</b> 36D305484 362411SOC-BHRM250OC	749,10 €	●



Conjunto termostático empotrado 1 vía con rociador metálico ø 250 mm.  
Shower set with thermostatic 1 way mixer, water outlet, handshower, metallic headshower ø 250 mm.

Cartucho Cartridge: 1703T + 1700C3/4"

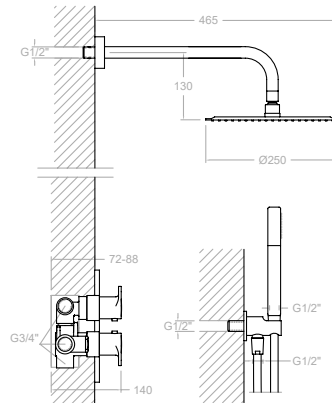

<b>K3687011</b> 36D302755 368712S-BHRM250+3713M+3796+2472C	597,90 €	●
<b>K3687011NM</b> 36D305486 368712SNM-BHRM250NM+3796NM+3714NM+2475CNC	1.080,40 €	●
<b>K3687011NC</b> 36D305488 368712SNC-BHRM250NC+3796NC+3714NC+2475CNC	1.080,40 €	●
<b>K3687011OC</b> 36D305487 368712SOC-BHRM250OC+3796OC+3714OC+2475COC	1.080,40 €	●



Conjunto termostático empotrado 2 vías con soporte, toma de agua, teleducha y rociador metálico ø 250 mm.  
Shower set with thermostatic 2 ways mixer, water outlet, handshower, metallic headshower ø 250 mm.

Cartucho Cartridge: 1703T + 4000

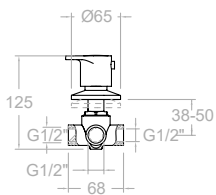

<b>9437</b> 94F305436	157,50 €	●
<b>9437NM</b> 94F305437	275,60 €	●
<b>9437NC</b> 94F305439	275,60 €	●
<b>9437OC</b> 94F305438	275,60 €	●

Inversor de 3 vías, mural.  
3 way diverter.

<b>94071/2X1</b> 94F305427	94,90 €	●
<b>94071/2X1NM</b> 94F305429	166,00 €	●
<b>94071/2X1NC</b> 94F305432	166,00 €	●
<b>94071/2X1OC</b> 94F305430	166,00 €	●

Llave de paso de 1/2".  
1/2" angle valve.

<b>94073/4X1</b> 94F305428	124,60 €	●
<b>94073/4X1NM</b> 94F305433	217,90 €	●
<b>94073/4X1NC</b> 94F305435	217,90 €	●
<b>94073/4X1OC</b> 94F305434	217,90 €	●

Llave de paso de 3/4".  
3/4" angle valve.

Cartucho Cartridge: 1000 I  
Set de ampliación Extension set: KAI3V

Montura Head: 5000  
Set de ampliación Extension set: KALLP

Montura Head: 6000  
Set de ampliación Extension set: KALLP

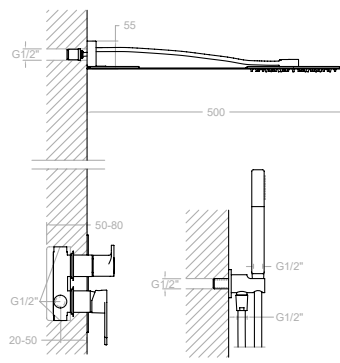
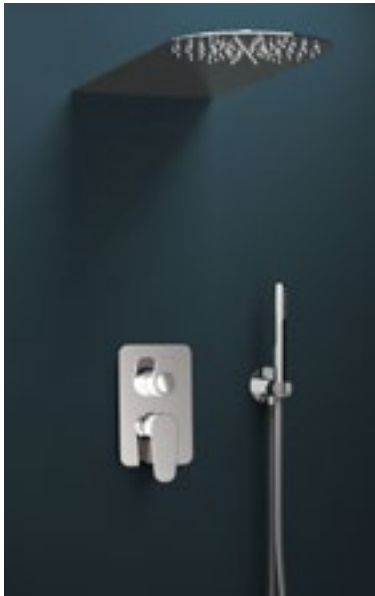

**SK3615021**

36C301400

361502S + 3713M + 2472C + 3796

294,10 €



+

**RR**

99Z300711

746,40 €

Conjunto monomando empotrado 2 vías con soporte más toma de agua, teleducha metálica y rociador de acero inoxidable extrafino de pared efecto lluvia.

Concealed single mixer lever 2 ways with metal hand shower and extra-thin stainless steel wall shower head with rain effect.

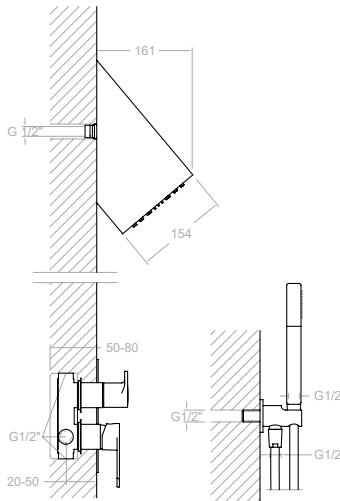

**SK3615021**

36C301400

361502S + 3713M + 2472C + 3796

294,10 €



+

**RIR**

99Z300702

673,00 €

Conjunto monomando empotrado 2 vías con soporte más toma de agua, teleducha metálica y rociador de acero inoxidable cascada de pared.

Concealed single mixer lever 2 ways with metal hand shower and stainless steel wall shower head with rain effect.

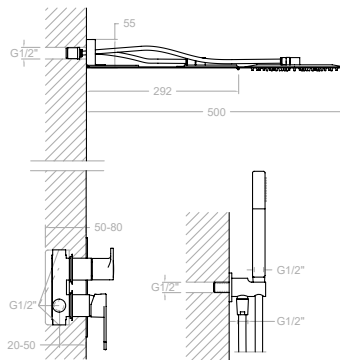

**SK3615031**

36C301401

361503S + 3713M + 2472C + 3796

327,70 €



+

**RRC**

99Z300710

978,90 €

Conjunto monomando empotrado 3 vías con soporte más toma de agua, teleducha metálica y rociador de acero inoxidable extrafino, efecto lluvia ó cascada.

Concealed single mixer lever 3 ways with metal hand shower and extra-thin stainless steel wall shower head rain or waterfall effect.

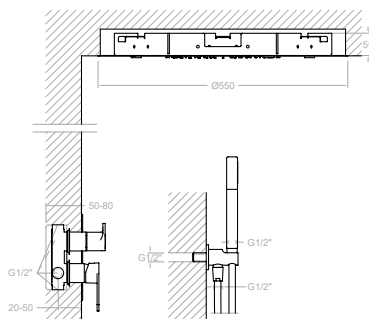

**SK3615031** 327,70 €

36C301401  
361503S + 3713M + 2472C + 3796

+

**RELN550** 1.237,00 €

99Z300722

Conjunto monomando empotrado 3 vías con soporte más toma de agua, teleducha metálica y rociador redondo de acero inoxidable extrafino, empotrado 550 mm. con lluvia ó nebulizador.

Concealed single mixer lever 3 ways with metal hand shower and concealed ceiling extra-thin stainless steel shower head, 550mm with rain or nebulizer effect.





<b>365402RM300</b> 36D303728 361202S+DN130D+RM300+3713M+2472C	868,40 €	●
<b>365402RM250NM</b> 36D303738 361202SNM+DN130DNM+RM250NM+3714NM+2475CNM	1.578,70 €	●
<b>365402RM250NC</b> 36D303736 361202SNC+DN130DNC+RM250NC+3714NC+2475CNC	1.578,70 €	●
<b>365402RM250OC</b> 36D303740 361202SOC+DN130DOC+RM250OC+3714OC+2475COC	1.578,70 €	●

Columna telescópica termostática, rociador metálico y accesorios metálicos.

Thermostatic shower telescopic column, metallic round headshower and metallic accessories.

<b>361202S</b> 36D303733	263,00 €	●
<b>361202SNM</b> 36D303745	477,70 €	●
<b>361202SNC</b> 36D303743	477,70 €	●
<b>361202SOC</b> 36D303747	477,70 €	●

Cuerpo termostático ducha.  
Thermostatic shower mixer.

Cartucho Cartridge: 1703T + 4000

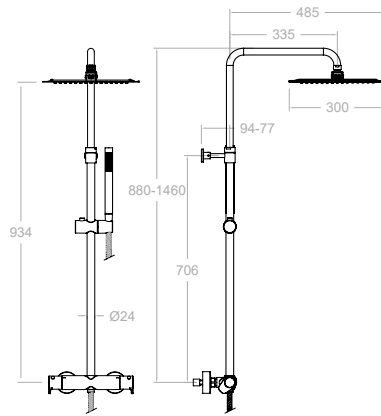

**365402RK300N**

921,30 €

36D303727

361202S+DN130D+RK300N+4713MK+2472C

Columna telescópica termostática, rociador cuadrado metálico y accesorios metálicos.

Thermostatic shower telescopic column, metallic squared headshower and metallic accessories.

Cartucho Cartridge: 1703T + 4000

**361202S**

263,00 €

36D303733

Cuerpo termostático ducha.

Thermostatic shower mixer.

Alexia

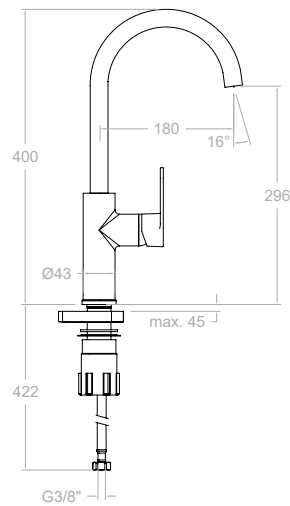
**360602**

134,40 €

36E301593

Monomando para fregadero.

Sink mixer.



Cartucho Cartridge: 35100 (6689-2)

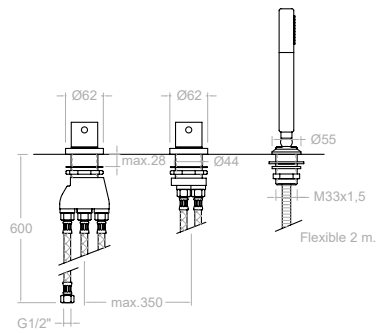

**3633TSCAM**  
36C300368

638,00 €

Termostático de ducha de repisa con equipo de ducha metálico.  
Thermostatic deck-mounted shower mixer.

Cartucho Cartridge: 1700 TE + 4000  
T3633+D3633+3713M+9989SC+2850C

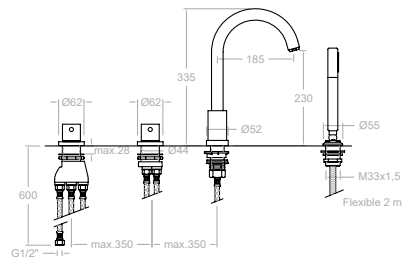

**363302TM**  
36C301648

901,70 €

Termostático de baño- ducha de repisa con caño y equipo de ducha metálico.  
Thermostatic deck-mounted bath shower mixer with metallic shower set and spout.

Cartucho Cartridge: 1700 TE + 4000  
T3633+D3633+3713M+9989SC+C623302+2850C

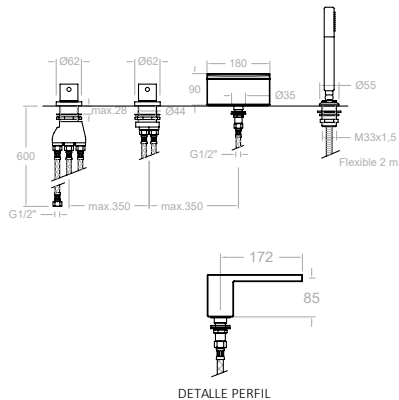

**363303TM**  
36C302908

1.386,00 €

Termostático de baño- ducha de repisa con caño cascada y equipos de ducha metálico.  
Thermostatic deck-mounted bath shower mixer with metallic shower set and cascade spout.

Cartucho Cartridge: 1700 TE + 4000  
T3633+D3633+3713M+9989SC+CR01+2850C



Recomendaciones Recommendations

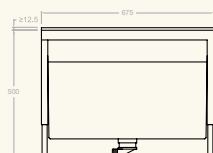

**100502**  
AAZ302174

699,00 €

Repisa extraíble con depósito para el agua de conjunto baño.  
Mounting block with heightadjustable panel and tube box for bath deck (included).

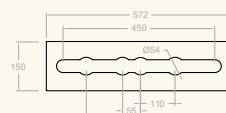

**100502R**  
AAZ302626

204,70 €

Repisa soporte para conjunto baño.  
Mounting plate for bath deck.





# Tzar

Colección Collection



## Características Técnicas

- Cartucho cerámico Ø35 mm
- Cartuchos monomando con Sistema Termostop Block de limitación de la temperatura máxima del agua caliente y Sistema de ahorro de agua S2 (disponible C2 en algunos modelos) mediante la apertura de la manecilla en dos fases.
- Cartucho termostático con Sistema Hot Block de seguridad antiquemaduras y Sistema Termostop de bloqueo de la temperatura a 38°C.
- Caudal a 3 bar: Lavabo y Fregadero (de 11 l/min). Bidé (5 l/min). Ducha (12 l/min). Baño (20 l/min).
- Nivel acústico a 3 bar: < 20 dB.
- Cromado latón: 15 micras de espesor de níquel, 0.3 micras de cromo.
- Prestaciones de confort a nivel de fidelidad, sensibilidad y constancia en la selección de la temperatura.
- Resiste presiones estáticas ≤ 10 bar y golpes de ariete de 25 bar.
- Temperatura recomendada de agua caliente 55°C. Temperatura máxima de uso 65°C. Máximo 1h a 90°C.
- Presión de uso entre 1-5 bar. Recomendada 3 bar.
- Resistente al choque térmico y químico anti legionela.
- Ánodo de sacrificio anticorrosión de zinc-magnesio
- Cooltouch, sistema que permite mantener la grifería templada al tacto para evitar quemaduras.

## Technical Characteristics

- Ceramic cartridge Ø35 mm.
- Mixer tap cartridge with Thermostop Block System to limit the maximum hot water temperature and S2 Water Saving System (C2 available in some models) using a lever that opens in two phases.
- Thermostatic cartridge with Hot Block System for protecting against burns and Thermostop System to limit the temperature to 38°.
- Water flow at 3 bar: Bathroom Sink and Kitchen Sink (11 l/min). Bidet (5 l/min). Shower (12 l/min). Bath (20 l/min).
- Sound level at 3 bar: < 20 dB.
- Chrome-plated brass: 15-micron thick nickel, 0.3 microns of chrome.
- Convenient with reliable, sensitive and consistent temperature selection.
- Withstands static pressures ≤ 10 bar and water hammer up to 25 bar.
- Recommended hot water temperature 55°C. Maximum usage temperature 65°C. Maximum 1 hour at 90°C.
- Usage pressure between 1-5 bar. Recommended 3 bar.
- Resistant to thermal shock and anti-legionella chemicals.
- Zinc-magnesium anti-corrosion sacrificial anode.
- Cooltouch, a system that allows the tap to be kept warm to the touch to avoid burns.

## Acabados disponibles Finishing availables

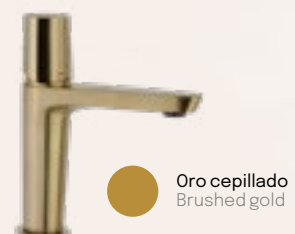
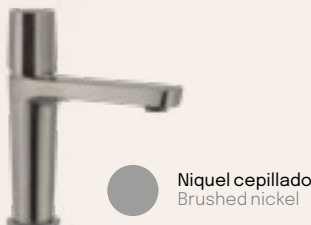



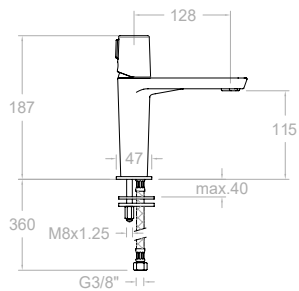

<b>340401</b> 34A302435	125,60 €	●
<b>340401NM</b> 34A302369	193,70 €	●
<b>340401NC</b> 34A302368	225,90 €	●
<b>340401OC</b> 34A302370	225,90 €	●



Monomando lavabo.  
High wash basin mixer.

Cartucho Cartridge: 35100-3

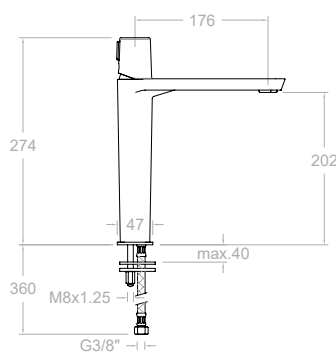

<b>341001</b> 34A302437	177,80 €	●
<b>341001NM</b> 34A302375	274,40 €	●



Monomando lavabo (L).  
High wash basin mixer (L).

Cartucho Cartridge: 35100-3

Recomendaciones Recommendations

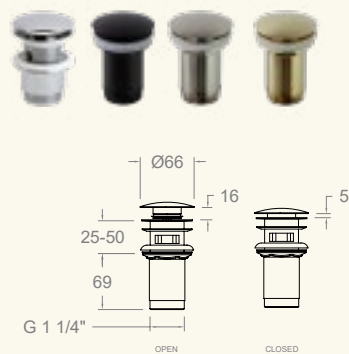

<b>1219L</b> 197106	27,40 €	●
<b>1219LNM</b> 99Z302477	41,10 €	●
<b>1219LNC</b> 99Z302476	48,30 €	●
<b>1219LOC</b> 99Z302478	48,30 €	●

Valvula metálica para desagüe sistema  
CLICK CLACK-Latón.  
Metal CLICK CLACK waste brass valve.

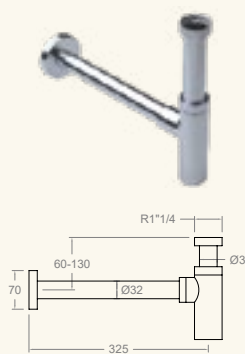

<b>3790</b> 198960	65,80 €	●
<b>3790NM</b> 99Z302332	100,90 €	●
<b>3790NC</b> 99Z302331	122,90 €	●
<b>3790OC</b> 99Z302333	122,90 €	●

Sifón.  
Bottletrap.

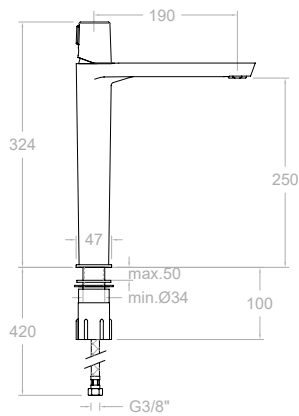

<b>340201</b> 34A302436	226,30 €	
<b>340201NM</b> 34A302352	349,20 €	
<b>340201NC</b> 34A302351	407,40 €	
<b>340201OC</b> 34A302354	407,40 €	

Monomando de lavabo (XL).  
High wash basin mixer (XL).

Cartucho Cartridge: 35100-3

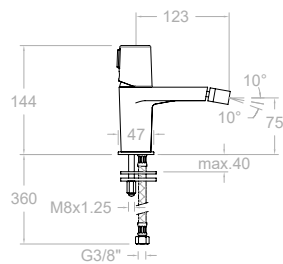

 <b>340301</b> 34B302438	112,60 €	
 <b>340301NM</b> 34B302365	173,60 €	
<b>340301NC</b> 34B302364	202,40 €	
<b>340301OC</b> 34B302366	202,40 €	

Monomando de bidé.  
Bidet mixer.

Cartucho Cartridge: 35100-3





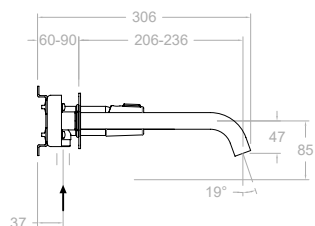
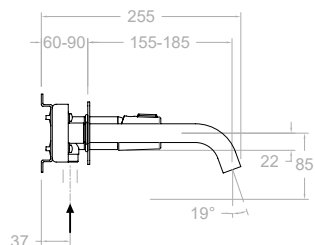
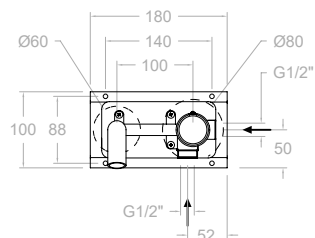

KIT DE AMPLIACIÓN - EXTENSION SET: KAB

- XX20CT+3400N-35+CLET24+RB21S+RB21H
- XX20CTNM+3400N-35NM+CLET24M+RB21SNM+RB21HNM
- XX20CTNC+3400N-35NC+CLET24NC+RB21SNC+RB21HNC
- XX20CTOC+3400N-35OC+CLT24OC+RB21SOC+RB21HOC

<b>342103</b> 34A302441	276,50 €	●
<b>342103NM</b> 34A302489	426,30 €	●
<b>342103NC</b> 34A302487	497,30 €	●
<b>342103OC</b> 34A302490	497,30 €	●

Monomando de lavabo empotrado mural con caño de 24 cm.  
Concealed wash basin mixer with 24 cm. spout.

<b>342101</b> 34A302440	265,90 €	●
<b>342101NM</b> 34A302903	410,10 €	●
<b>342101NC</b> 34A302905	478,20 €	●
<b>342101OC</b> 34A302904	478,20 €	●

Monomando de lavabo empotrado mural con caño de 19 cm.  
Concealed wash basin mixer 19 cm spout.  
Cartucho Cartridge: 35100-2

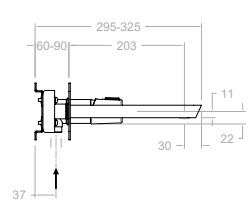
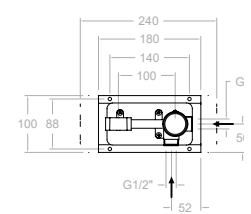

KIT DE AMPLIACIÓN - EXTENSION SET: KAB

<b>342001</b> 34A302439	306,90 €	●
<b>342001NM</b> 34A302484	473,30 €	●
<b>342001NC</b> 34A302483	552,40 €	●
<b>342001OC</b> 34A302485	552,40 €	●

Monomando de lavabo empotrado mural con placa.  
Concealed wash basin mixer.  
Cartucho Cartridge: 35100-2

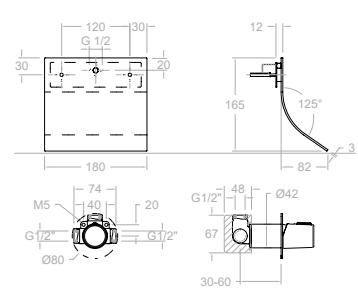

KIT DE AMPLIACIÓN - EXTENSION SET: KA1V

<b>341691</b> 34A302465	573,90 €	●
----------------------------	----------	---

Monomando de lavabo empotrado mural con caño cascada extraplano.  
Wall washbasin mixer with ultraslim cascade spout.



Cartucho Cartridge: 35100

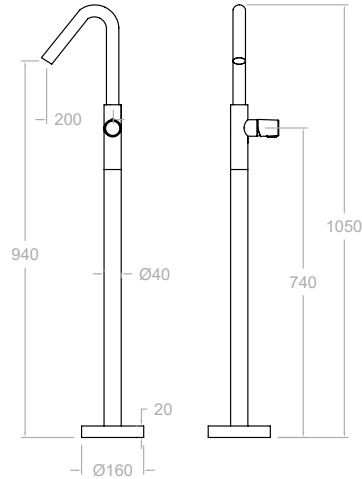

<b>347602S</b> 34A303369	897,40 €	●
<b>347602SNM</b> 34A303863	1.614,70 €	●
<b>347602SNC</b> 34A303864	1.614,70 €	●
<b>347602SOC</b> 34A303865	1.614,70 €	●

Monomando lavabo de columna.  
Washbasin column mixer.



Cartucho Cartridge: 35100-2

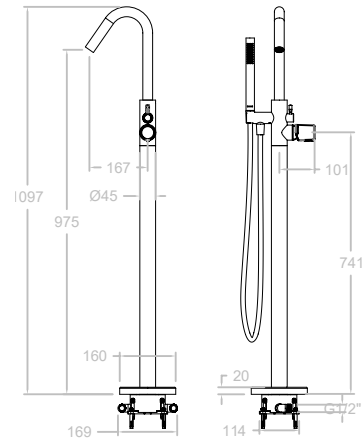

<b>348503S</b> 34C303356	1.212,80 €	●
<b>348503SNM</b> 34C303383	2.182,50 €	●
<b>348503SNC</b> 34C303386	2.182,50 €	●
<b>348503SOC</b> 34C303384	2.182,50 €	●

Columna monomando para bañera.  
Free standing bath shower column.



<b>348503MO</b> 34C303357 348501S+3713M+2471C	1.319,10 €	●
<b>348503DNM</b> 34C303387 348503SNM+3714NM+2475CNM	2.347,90 €	●
<b>348503DNC</b> 34C303389 348503SNC+3714NC+2475CNC	2.347,90 €	●
<b>348503DOC</b> 34C303388 348503SOC+3714OC+2475COC	2.347,90 €	●

Columna monomando para bañera con equipo de ducha.  
Free standing bath shower column with shower set.



Cartucho Cartridge: 35100-2

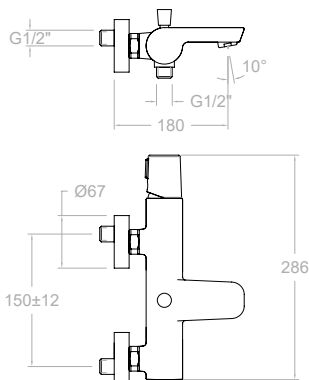

**340501S**

34C302442

167,10 €



**340501SNM**

34C303664

307,10 €



Monomando de baño - ducha sin equipo de ducha.  
Bath and shower mixer without shower set.



Cartucho Cartridge: 35100 (6689 C2)



**TR**

**340501TR**

34C302444

266,90 €



Conjunto monomando de baño- ducha con equipo de ducha.  
Bath and shower mixer with shower set.



340501 S + 5813 TR



**BT**

**340501BTNM**

34C303669

456,30 €



Conjunto monomando de baño- ducha con equipo de ducha.  
Bath and shower mixer with shower set.



372602NM + 2475CNM + 340501SNM + 2876BTNM

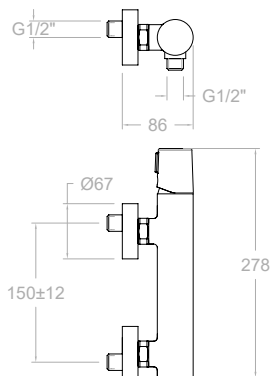

**340801S**

34D302445

130,20 €



**340801SNM**

34D303665

240,90 €



Monomando de ducha sin equipo de ducha.  
Shower mixer without shower set.



Cartucho Cartridge: 35100-3



TR

**340801TR**

34D302446

230,00 €

Conjunto monomando de ducha con equipo de ducha.  
Shower mixer with shower set.



340801S + 5813TR



BT

**340801BTNM**

34C303670

390,10 €

Conjunto monomando de ducha con equipo de ducha.  
Shower mixer with shower set.



372602NM + 2475CNM + 340801SNM + 2876BTNM

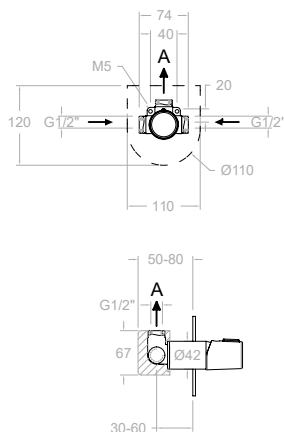

**341801S**

34D302466

XX1801-3400N-35-KU1

111,30 €

**341801SNM**

34C302393

XXX1801NM+KU1NM+3400N-35 NM

200,60 €

**341801SNC**

34C302392

XXX1801NC+KU1NC+3400N-35 NC

200,60 €

**341801SOC**

34C302481

XXX1801OC+KU1OC+3400N-35 OC

200,60 €

Monomando de ducha empotrado 1vía con placa metálica.  
Single lever concealed mixer 1 way with ultraslim metallic plate.



XX1801	1bar	3bar	5bar
A l/min	17	26	31
Kit de ampliación - Extension set: KA1V			

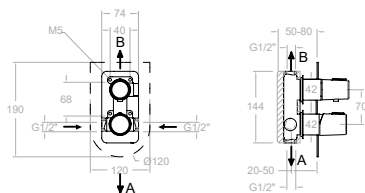

**341502S** 202,50 €

34C302454

XX1502+3400N-35+345100+KU2



**341502SNM** 364,30 €

34C302384

XXX1502NM+KU2NM+3400N-35 NM+345100NM

**341502SNC** 364,30 €

34C302383

XX1502NC+KU2NC+3400N-35 NC +345100NC

**341502SOC** 364,30 €

34C302385

XX1502OC+KU2OC+3400N-35 OC+345100OC

Monomando de baño-ducha empotrado 2 vía con placa metálica.

Single lever concealed mixer 2 way with ultraslim metallic plate.

## 2 Vías/Ways

XX1502	1bar	3bar	5bar
A l/min	14	24	30
B l/min	13	22	29

Kit de ampliación - Extension set: KA2V

Cartucho Cartridge: 35100 (6689-2) + 4004

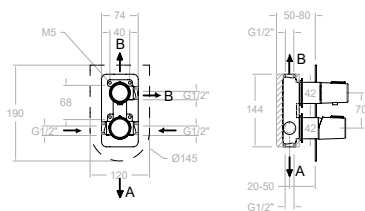

**341503S** 222,70 €

34C302525

XX1503+3400N-35+345100+KU3



**341503SNM** 400,70 €

34C302388

XXX1503NM+KU3NM+3400N-35 NM+345100NM

**341503SNC** 400,70 €

34C302387

XX1503NC+KU3NC+3400N-35 NC +345100NC

**341503SOC** 400,70 €

34C302390

XX1503OC+KU3OC+3400N-35 OC+345100OC

Monomando de ducha empotrado 3 vía con placa metálica.

Single lever concealed mixer 3 way with ultraslim metallic plate.

## 3 Vías/Ways

XX1503	1bar	3bar	5bar
A l/min	13	22	28
B l/min	13	21	26
B l/min	13	21	26

Kit de ampliación - Extension set: KA3V

Cartucho Cartridge: 35100 (6689-2) + 4003

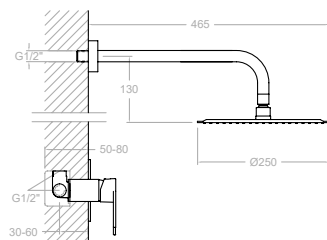

<b>K3418012</b> 34D302876 341801S+BHRM250	343,00 €	
<b>K3418012NM</b> 34D302890 341801SNM+BHRM250NM	617,50 €	
<b>K3418012NC</b> 34D302892 341801SNC+BHRM250NC	617,50 €	
<b>K3418012OC</b> 34D302891 341801SOC+BHRM250OC	617,50 €	

Conjunto monomando empotrado 1 vía con rociador metálico Ø 250 mm.

Single lever 1 way with metal wall shower head Ø 250 mm.



Cartucho Cartridge: 35100

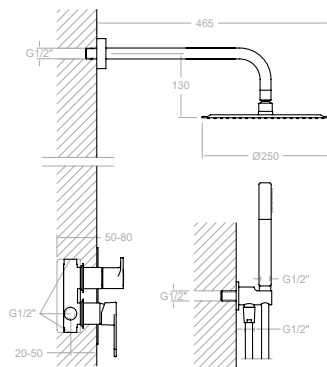
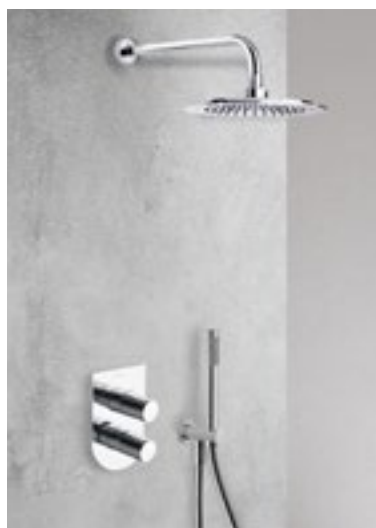

<b>K3415021</b> 34D302878 341502S+BHRM250+3713M+3796+2472C	544,70 €	
<b>K3415021NM</b> 34D302896 341502SNM+BHRM250NM+3714NM+3796NM+2475CNM	979,90 €	
<b>K3415021NC</b> 34D302898 341502SNC+BHRM250NC+3714NC+3796NC+2475CNC	979,90 €	
<b>K3415021OC</b> 34D302897 341502SOC+BHRM250OC+3714OC+3796OC+2475COC	979,90 €	

Conjunto monomando empotrado 2 vías con soporte, toma de agua, teleducha y rociador metálico mural Ø 250 mm.

Shower set with concealed single lever 2 ways mixer, water outlet, handshower, metallic headshower Ø 250 mm.



Cartucho Cartridge: 35100+4004



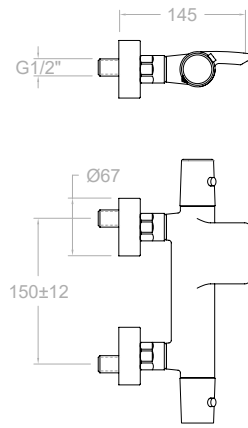

<b>343901S</b> 34C302449	307,60 €	●
<b>343901SNM</b> 34C302502	553,30 €	●
<b>343901SNC</b> 34C302501	553,30 €	●
<b>343901SOC</b> 34C302503	553,30 €	●



Termostático de baño-ducha salida cascada, sin equipo de ducha.  
Thermostatic bath shower mixer with cascade stream, without shower set.



D1

<b>343901DNM</b> 34C302680 343901SNM+3714NM+372602NM+2475CNM	743,70 €	●
<b>343901DNC</b> 34C302679 343901SNC+3714NC+372602NC+2475CNC	743,70 €	●
<b>343901DOC</b> 34C302681 343901SOC+37140C+3726020C+2475C0C	743,70 €	●



Termostático de baño-ducha salida cascada, con equipo de ducha.  
Bathtub thermostatic with cascade stream, with shower set.



TR

<b>343901TR</b> 34C302464	407,40 €	●
------------------------------	----------	---



Termostático de baño-ducha salida cascada, con equipo de ducha.  
Bathtub thermostatic with cascade stream, with shower set.

343901S + 5813TR

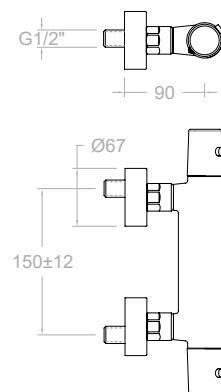

<b>343402S</b> 34D3306712	252,80 €	●
<b>343402SNM</b> 34D3306713	454,70 €	●
<b>343402SNC</b> 34D3306714	454,70 €	●
<b>343402SOC</b> 34D3306715	454,70 €	●



Termostático de ducha, sin equipo de ducha.  
Thermostatic shower mixer, without shower set.

Cartucho Cartridge: 1701 T + 1700C 1/2"



D1

**343402DNM**

645,10 €

34D306708

343402SNM+3714NM+372602NM+2475CNM



**343402DNC**

645,10 €

34D306710

343402SNC+3714NC+372602NC+2475CNC



**343402DOC**

645,10 €

34D306711

343402SOC+3714OC+372602OC+2475COC



Termostático de ducha, con equipo de ducha.

Thermostatic shower mixer, with shower set.



TR

**343402TR**

352,60 €

34D306716



Termostático de ducha, con equipo de ducha.

Thermostatic shower mixer, with shower set.



343402S + 2877TR + 3726M + 2472C

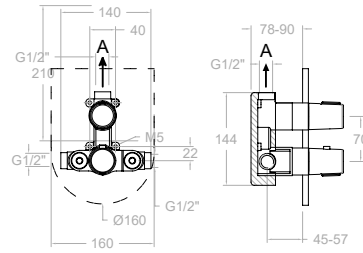

**1 Via/Way**

- 342411S** 190,10 €  
 34D302526  
 XX2411-KTU1-345000-345100
- 342411SNM** 345,60 €  
 34D302493  
 XX2411NM-KTU1NM-345000NM-345100NM
- 342411SNC** 345,60 €  
 34D302492  
 XX2411NC-KTU1NC-345000NC-345100NC
- 342411SOC** 345,60 €  
 34D302494  
 XX2411OC-KTU1OC-345000OC-345100OC



Termostático de ducha empotrado 1 vía con placa metálica.  
 Thermostatic concealed mixer 1 way with ultraslim metallic plate.

XX2411S	1bar	3bar	5bar
A l/min	17	26	31
Kit de ampliación - Extension set: KETDI04			

Cartucho Cartridge: 1703T + 1700C3/4"

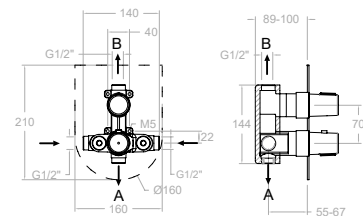

**2 Vías/Ways**

- 348712S** 266,00 €  
 34D302527  
 XX8712-KTU2-345000-345100
- 348712SNM** 483,30 €  
 34D302511  
 XX8712NM-KTU2NM-345000NM-345100NM
- 348712SNC** 483,30 €  
 34D302510  
 XX8712NC-KTU2NC-345000NC-345100NC
- 348712SOC** 483,30 €  
 34D302512  
 XX8712OC-KTU2OC-345000OC-345100OC



Termostático de baño-ducha empotrado 2 vías con placa metálica extraplana.  
 Thermostatic concealed mixer 2 ways with ultraslim metallic plate.

XX8712S	1bar	3bar	5bar
A l/min	17	26	31
B l/min	13	22	28
Kit de ampliación - Extension set: KETDI03			

Cartucho Cartridge: 1703T + 4000

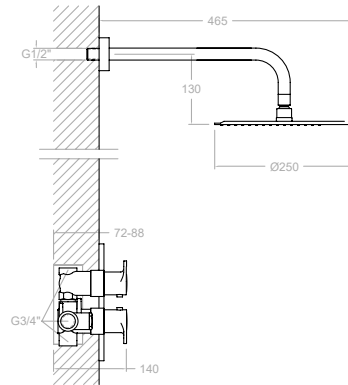

<b>K3424012</b> 34D302753 342411S-BHRM250 (B350+RM250)	421,80 €	●
<b>K3424012NM</b> 34D305477 342411SNM-BHRM250NM	762,40 €	●
<b>K3424012NC</b> 34D305479 342411SNC-BHRM250NC	762,40 €	●
<b>K3424012OC</b> 34D305478 342411SOC-BHRM250OC	762,40 €	●



Conjunto termostático empotrado 1 vía con rociador metálico ø 250 mm.  
Shower set with thermostatic 1 way mixer, metallic headshower ø 250 mm.

Cartucho Cartridge: 1703T + 1700C3/4"

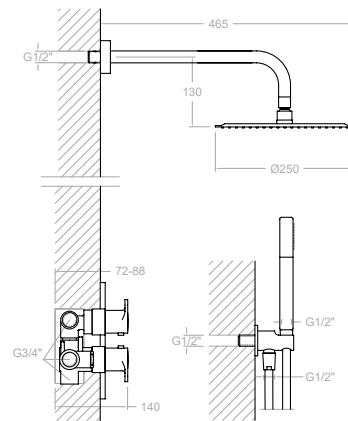

<b>K3487011</b> 34D302759 348712S-BHRM250+3713M+3796+2472C	608,10 €	●
<b>K3487011NM</b> 34D305480 348712SNM+BHRM250NM+3714NM+3796NM+2475CNM	1.098,90 €	●
<b>K3487011NC</b> 34D305482 348712SNC+BHRM250NC+3714NC+3796NC+2475CNC	1.098,90 €	●
<b>K3487011OC</b> 34D305481 348712SOC+BHRM250OC+3714OC+3796OC+2475COC	1.098,90 €	●



Conjunto termostático empotrado 2 vías con soporte, toma de agua, teleducha y rociador metálico ø 250 mm.  
Shower set with thermostatic 2 ways mixer, water outlet, handshower, metallic headshower ø 250 mm.

Cartucho Cartridge: 1703T + 4000

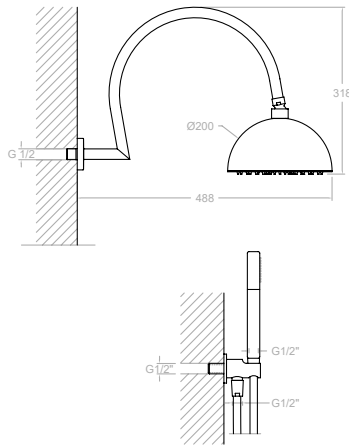
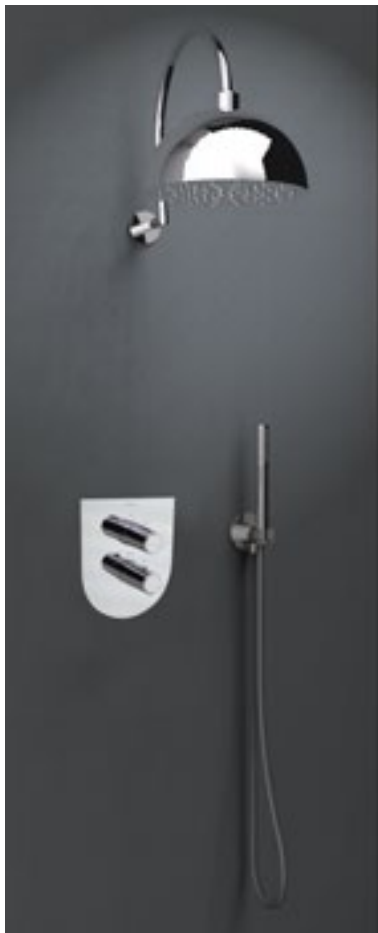

**SK3487011** 376,50 €  
 34D302764  
 348712S-3713M-3796-2472C

**RB2A390** 875,50 €  
 99H300748

**SK3487011NM** 682,10 €  
 34D305400  
 348712SNM-3714NM-3796NM-2475CNM

**RB2A390NM** 1.560,80 €  
 99H305057

**SK3487011NC** 682,10 €  
 34D305402  
 348712SNC-3714NC-3796NC-2475CNC

**RB2A390NC** 1.560,80 €  
 99H305056

Conjunto termostático empotrado 2 vías con soporte más toma de agua, teleducha metálica y rociador redondo Ø 200 mm de acero inoxidable con brazo mural.

Concealed thermostatic 2 ways with metal hand shower and round shower head Ø 200 mm stainless steel with wall arm.

Cartucho Cartridge: 1703T + 4000

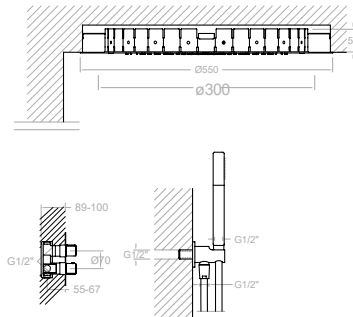
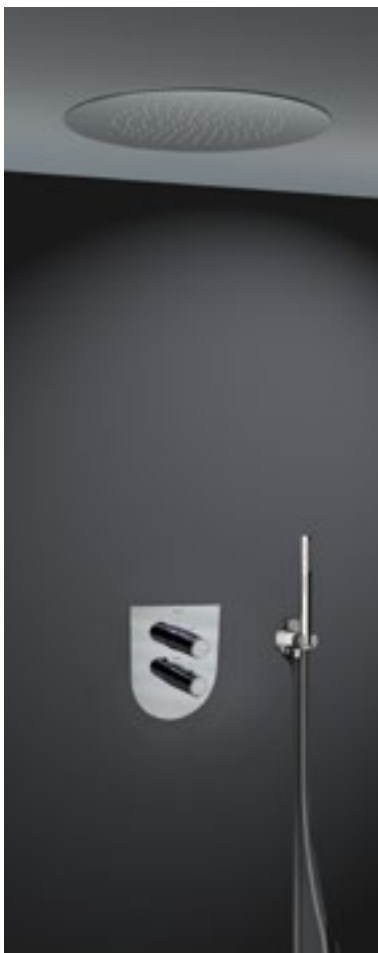

**SK3487011** 376,50 €  
 34D302764  
 218712S-3713M-3796-2472C

**RE550** 944,90 €  
 99Z300721

Conjunto termostático empotrado 2 vías con soporte más toma de agua, teleducha metálica y rociador redondo de acero inoxidable extrafino empotrado Ø 550 mm.

Concealed thermostatic 2 ways concealed with metal hand shower and round stainless steel shower head extra-thin Ø 550mm.

Cartucho Cartridge: 1703T + 4000



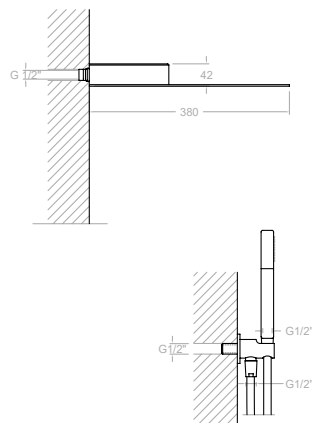

**SK3487011**

376,50 €

34D302764

348712S+3713M+3796+2472C

+

**RC**

489,60 €

99Z300698

Conjunto termostático empotrado 2 vías con soporte más toma de agua, teleducha metálica y rociador de acero inoxidable cascada de pared.

Concealed thermostatic 2 ways metal hand shower and stainless steel wall waterfall shower head.



Cartucho Cartridge: 1703T + 4000



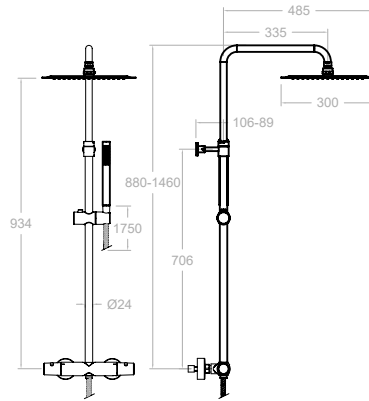

**345402RK300N**

953,80 €

34D303725

Columna telescópica termostática, rociador cuadrado metálico y accesorios metálicos.  
Thermostatic shower telescopic column, metallic squared headshower and metallic accessories.

Cartucho Cartridge: 1703T + 4000



**341202S**

285,50 €

34D303525

Cuerpo termostático ducha.  
Thermostatic shower mixer.

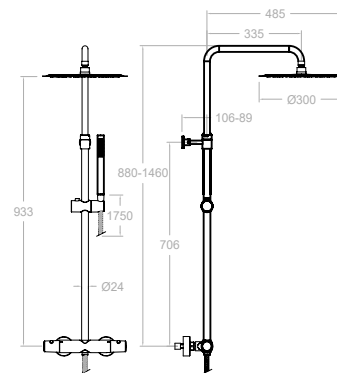

**345402RM300**

908,90 €

34D303726

341202S+DN130D+RM300+3713M+2472C

**345402RM250NM**

1.532,20 €

34D303737

341202SNM+DN130DNM+RM250NM+3714NM+2475CNM

**345402RM250NC**

1.532,20 €

34D303735

341202SNC+DN130DNC+RM250NC+3714NC+2475CNC

**345402RM250OC**

1.532,20 €

34D303739

341202SOC+DN130DOC+RM250OC+3714OC+2475COC

Columna telescópica termostática, rociador Ø 300 mm metálico y accesorios metálicos.

Thermostatic shower telescopic column, metallic round headshower Ø 300 mm and metallic accessories.



**341202S**

285,50 €

34D303525

**341202SNM**

514,00 €

34D303744

**341202SNC**

514,00 €

34D303742

**341202SOC**

514,00 €

34D303746

Cuerpo termostático ducha.  
Thermostatic shower mixer.

Cartucho Cartridge: 1701T + 4000

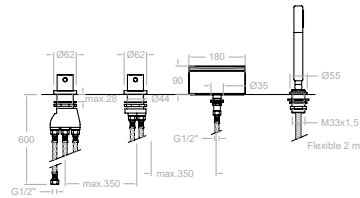

**343303TM**  
34C302458

1.417,10 €

Termostático de baño-ducha de repisa con caño cascada y equipo de ducha metálico.  
Thermostatic deck-mounted bath shower mixer with metallic shower set and cascade spout.



Cartucho Cartridge: 1700 TE + 4000

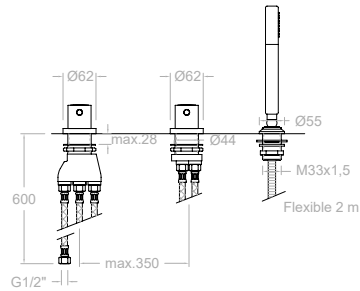

**343303TSCAM**  
34C302459

653,40 €

Termostático de ducha de repisa con equipo de ducha metálico.  
Thermostatic deck-mounted shower mixer.



Cartucho Cartridge: 1700 TE + 4000

Recomendaciones Recommendations

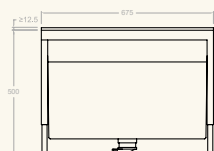

**100502**  
AAZ302174

699,00 €

Repisa extraíble con depósito para el agua de conjunto baño.  
Mounting block with heightadjustable panel and tube box for bath deck (included).

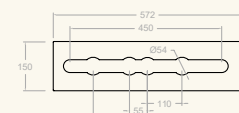

**100502R**  
AAZ302626

204,70 €

Repisa soporte para conjunto baño.  
Mounting plate for bath deck.

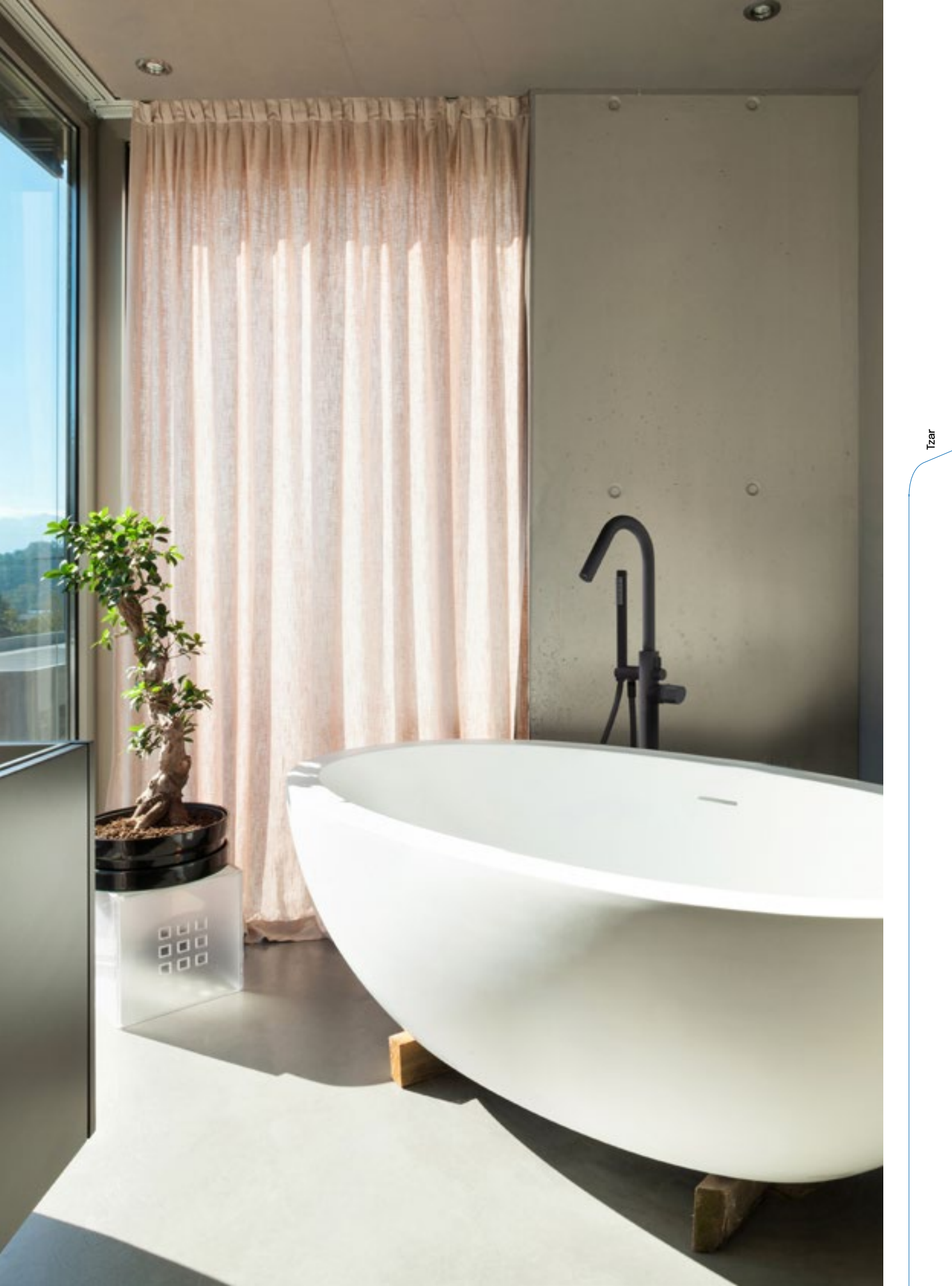

# Arola

Colección Collection



## Características Técnicas

- Cartucho cerámico monomando Ø25mm en Lavabo.
- Cartucho progresivo Ø35mm en Lavabo cascada, Bidet y Lavabo alto.
- Cartucho termostático con Sistema Hot Block de seguridad antiquemaduras y Sistema Termostop de bloqueo de la temperatura a 38°C.
- Caudal a 3 bar: Lavabo. Lavabo alto y Fregadero (9 l/min). Ducha (12 l/min). Baño (20 l/min).
- Nivel acústico a 3 bar < 20 dB.
- Latón: 15 micras de espesor de níquel, 0,3 micras de cromo.
- Presión de uso entre 1-5 bar, recomendada 3 bar. Resiste presiones estáticas ≤ 10 bar y golpes de ariete de 25 bar.
- Temperatura recomendada de agua caliente 55°C. Temperatura máxima de uso 65°C. Máximo 1h a 90°C.
- Resistente al choque térmico y químico anti-legionela.
- Salida de agua cascada caudal limitado.
- Cooltouch, sistema que permite mantener la grifería templada al tacto para evitar quemaduras.

## Technical Characteristics

- Ø25mm ceramic mixer tap cartridge.
- Ø35mm progressive cartridge for cascade taps, bidets and tall taps.
- Thermostatic cartridge with the Hot Block anti-burn system and the Termostop temperature blocking system (to 38°C).
- Flow rate at 3 bars: Washbasin; Tall tap and Sink (9 l/min.); Shower (12 l/min.) and Bath (20 l/min.).
- Acoustic level at 3 bars: < 20 dB.
- Plated brass: 15 microns thick of nickel, 0.3 microns of.
- Working pressure between 1-5 bars, recommended: 3 bars. It resists static pressures 10 bars and water hammers of 25 bars.
- Recommended temperature for the hot water: 55°C. Maximum working temperature: 65°C. Maximum: 1h at 90°C.
- Resistant to thermal and anti-Legionella chemical shocks.
- Cascade water outlet limited flow.
- Cooltouch, a system that keeps the faucet warm to the touch to avoid burns.

## Acabados disponibles Finishing availables



● Cromo  
Chrome



● Negro mate  
Black matte







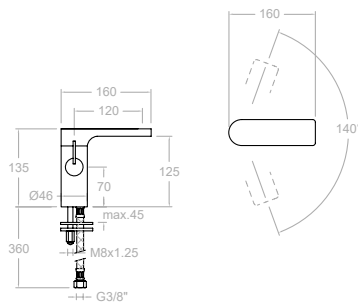

**2602**  
261777

277,20 €



Monomando de lavabo con caño giratorio y aireador.  
Washbasin single lever mixer with swivel spout and aerator.

Cartucho Cartridge: 25000

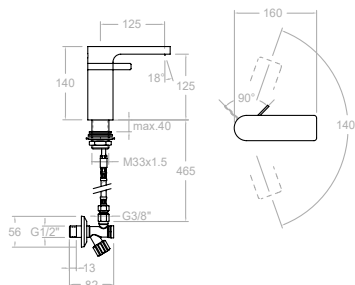

**2601**  
226428

421,50 €

**2601NM**  
26A302582

650,10 €



Monomando de lavabo con salida cascada, caño giratorio y cartucho progresivo de apertura en agua fría.  
Washbasin mixer, swivel spout and progressive cartridge with cold opening.



**3794\***  
AAZ301450

18,10 €

Llave de paso con filtro.  
Stopcock with filter.

\* INCLUIDA 3794 (x2).  
\* INCLUDED 3794 (x2)

Cartucho progresivo Progressive cartridge: 2600-P

## Recomendaciones Recommendations



**1219L**  
197106

27,40 €

**1219LNM**  
99Z302477

41,10 €

Válvula metálica para desagüe sistema CLICK CLACK-Latón.  
Metal CLICK CLACK waste brass valve.

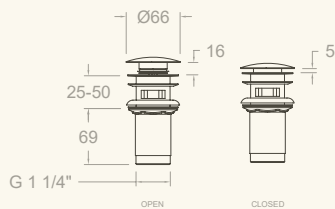

**3790**  
198960

65,80 €

**3790NM**  
99Z302332

100,90 €

Sifón  
Bottletrap

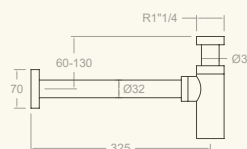

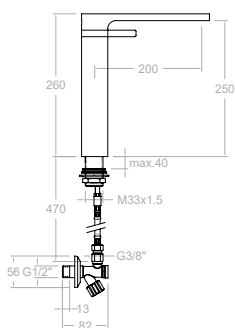

**2610** 229164 620,70 €

**2610NM** 26A302584 964,00 €

Monomando de lavabo (L) con aireador, caño giratorio y cartucho progresivo de apertura en agua fría.  
Tall washbasin mixer, swivel spout and progressive cartridge with cold opening.



**3794\*** AAZ301450 18,10 €

Llave de paso con filtro.  
Stopcock with filter.

\* INCLUIDA 3794 (x2).  
\* INCLUDED 3794 (x2)

Cartucho progresivo Progressive cartridge: 2600-P

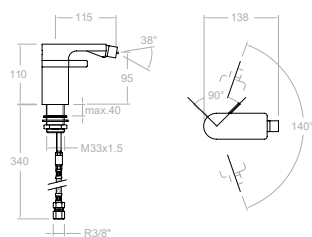

**2603** 226437 421,50 €

**2603NM** 26B302583 650,10 €

Monomando de bidé con salida de agua orientable y cartucho progresivo de apertura en agua fría.  
Bidet mixer, swivel spout and progressive cartridge with cold opening.

Cartucho progresivo Progressive cartridge: 2600-P



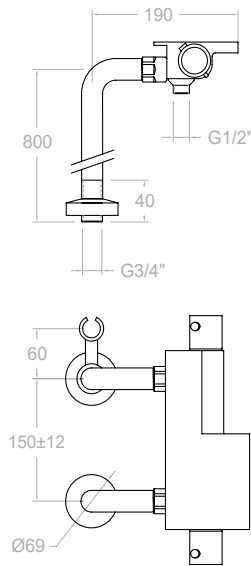

**2635S** 1.081,60 €  
226509 ●

Termostático de baño-ducha con salida cascada sobre columna.  
Thermostatic bath-shower mixer, high column with waterfall outlet, without shower set.



**2635MK** 1.188,70 €  
259017 ●

Termostático de baño-ducha con salida cascada sobre columna con equipo de ducha.  
Thermostatic bath-shower mixer, high column with waterfall outlet and complete shower set.



Cartucho Cartridge: 1700T + 4000

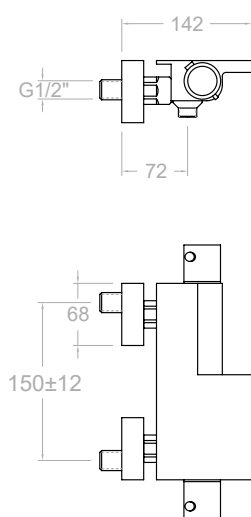

**2639S** 518,60 €  
226536 ●

**2639SNM** 800,00 €  
26C302586 ●

Termostático de baño-ducha con salida cascada.  
Thermostatic bath-shower mixer with waterfall outlet.



Cartucho Cartridge: 1700T + 4000



MK

**2639MK** 625,10 €  
 258891  
 2639 S+4713MK+4726M+2471C

**2639KNM** 980,50 €  
 26C302585  
 2639SNM+4714KNM+472602NM+2475CNM



Termostático de baño-ducha salida cascada con equipo de ducha.  
 Thermostatic bath-shower mixer, with waterfall outlet, and shower set.

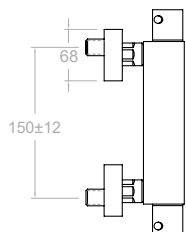
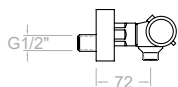

**263402S** 352,90 €  
 261873

**263402SNM** 544,50 €  
 261875



Termostático de ducha.  
 Thermostatic shower mixer without shower kit.

Cartucho Cartridge:1701T + 1700C1/2



MK

**263402MK** 459,40 €  
 261876  
 263402 S+4713MK+4726M+2471C

**263402KNM** 724,90 €  
 261878  
 263402SNM+4714KNM+472602NM+2475CNM



Termostático de ducha.  
 Thermostatic shower mixer without shower kit.

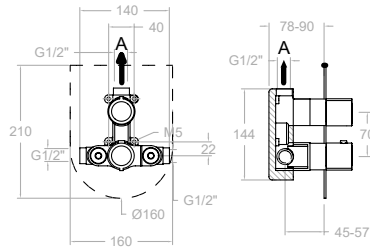

**262411S** 228,50 €

26D302529

**262411SNM** 352,50 €

26D304973

Termostático de ducha empotrado metálico 1 vía con placa ultraslim.

Thermostatic concealed shower 1 way with ultraslim plate.

XX2411	1bar	3bar	5bar
A l/min	17	26	31

Kit de ampliación - Extension set: KAETDI04



1 Vía/Way

Cartucho Cartridge: 1703T + 1700C3/4"

XX2411+KTU1+265000+265100

XX2411NM+KTU1NM+265000NM+265100NM

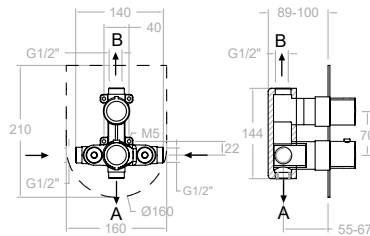

**268712S** 306,80 €

26D302538

**268712SNM** 473,30 €

26D304974

Termostático de baño-ducha empotrado metálico 2 vías con placa ultraslim.

Thermostatic concealed shower 2 ways.

XX8712S	1bar	3bar	5bar
A l/min	17	26	31
B l/min	13	22	28

Kit de ampliación - Extension set: KAETDI03



2 Vías/Ways

Cartucho Cartridge: 1703T + 4000

XX8712+KTU2+265000+265100

XX8712NM+KTU2NM+265000NM+265100NM

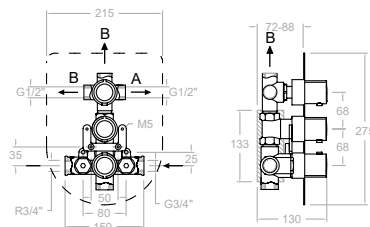

**2627S** 760,60 €

229533

Termostático de baño-ducha empotrado metálico 3 vías con placa ultraslim.

Thermostatic concealed bathshower mixer 3 ways with ultraslim plate.

XX8712S	CARTUCHO GRAN CAUDAL 1700 TE		
	1bar	3bar	5bar
A	13,5	23,3	30,2
B	9,3	15,5	19,2

Kit de ampliación - Extension set: KAETDI



3 Vías/Ways

Cartucho Cartridge: 1700TE + 1700C3/4 + 1000I

ETDI+KL23+2651+2655+2653

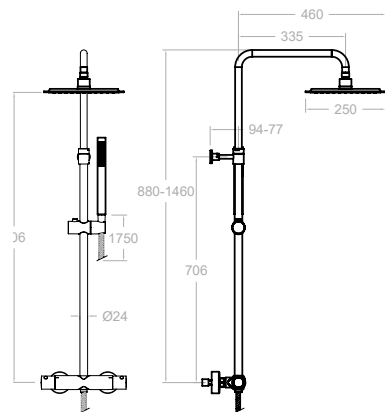

**265403RK250** 912,30 €

26D303718 ●

**265403RK250NM** 1.407,20 €

26D304975 ●

Columna de ducha telescópica termostática rociador metálico cuadrado 250mm.

Thermostatic shower column with telescopic bar.



**261203S** 320,70 €

26D303731 ●

**261203SNM** 494,60 €

26D304977 ●

Termostático de columna.

Thermostatic shower.

Cartucho Cartridge: 1703T + 4000

261203S+DN130D+RK250+4713MK+2471C

261203SNM+DN130DNM+RK250NM+4714KNM+2475CNM

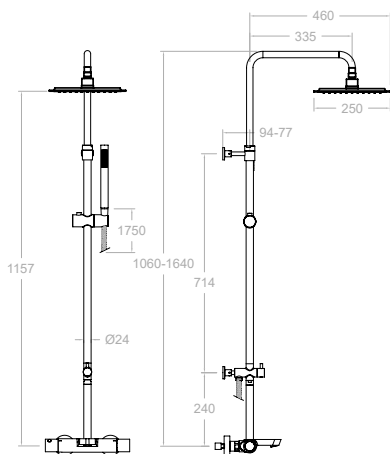

**265602RK250** 1.152,60 €

26C303798 ●

**265602RK250NM** 1.777,80 €

26C304976 ●

Columna de baño-ducha telescópica termostática rociador metálico cuadrado 250 mm.

Thermostatic bath-shower column with telescopic bar.



**264612S** 446,60 €

26C303808 ●

**264612SNM** 688,90 €

26C304978 ●

Termostático de baño-ducha.

Thermostatic bath-shower mixer

Cartucho Cartridge: 1701T + 4000

264612S+DN130D+T18+IPD16+RK250+4716PR+2471C

264612SNM+DN130DNM+T18NM+IPD16NM+RK250NM+4714KNM+2475CNM



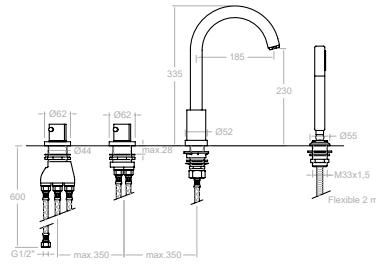

**263303TM**  
26C301649

922,70 €

Termostático de repisa para bañera con equipo de ducha metálico.  
Deck mounted thermostatic bathub set with shower kit.

Cartucho Cartridge:1700 TE + 4000  
T2633+D2633+3713M+9989SC+C623302+2850C

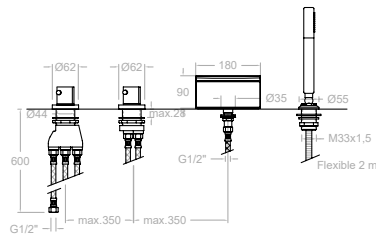

**263304TM**  
26C302909

1.415,10 €

Termostático de repisa para bañera con caño cascada y equipo de ducha metálico.  
Deck mounted thermostatic bathub set with waterfall and shower kit.

Cartucho Cartridge:1700 TE + 4000  
T2633+D2633+3713M+9989SC+CR01+2850C

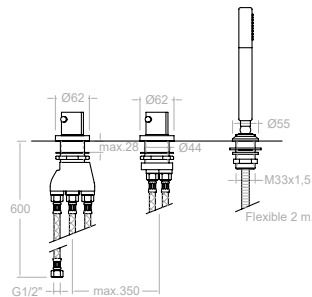

**2633TSCAM**  
255867

652,20 €

Termostático de repisa para bañera sin caño y con equipo de ducha metálico.  
Deck mounted thermostatic bathtub with shower kit, without bath spout.

Cartucho Cartridge: 1700 TE + 4000  
T2633+D2633+3713M+9989SC+2850C



Recomendaciones Recommendations

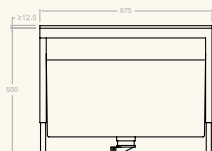

**100502**  
AAZ302174

699,00 €

Repisa extraíble con depósito para el agua de conjunto baño.  
Mounting block with heightadjustable panel and tube box for bath deck (included).

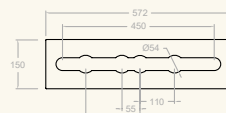

**100502R**  
AAZ302626

204,70 €

Repisa soporte para conjunto baño.  
Mounting plate for bath deck.

# Kuatro

Colección Collection

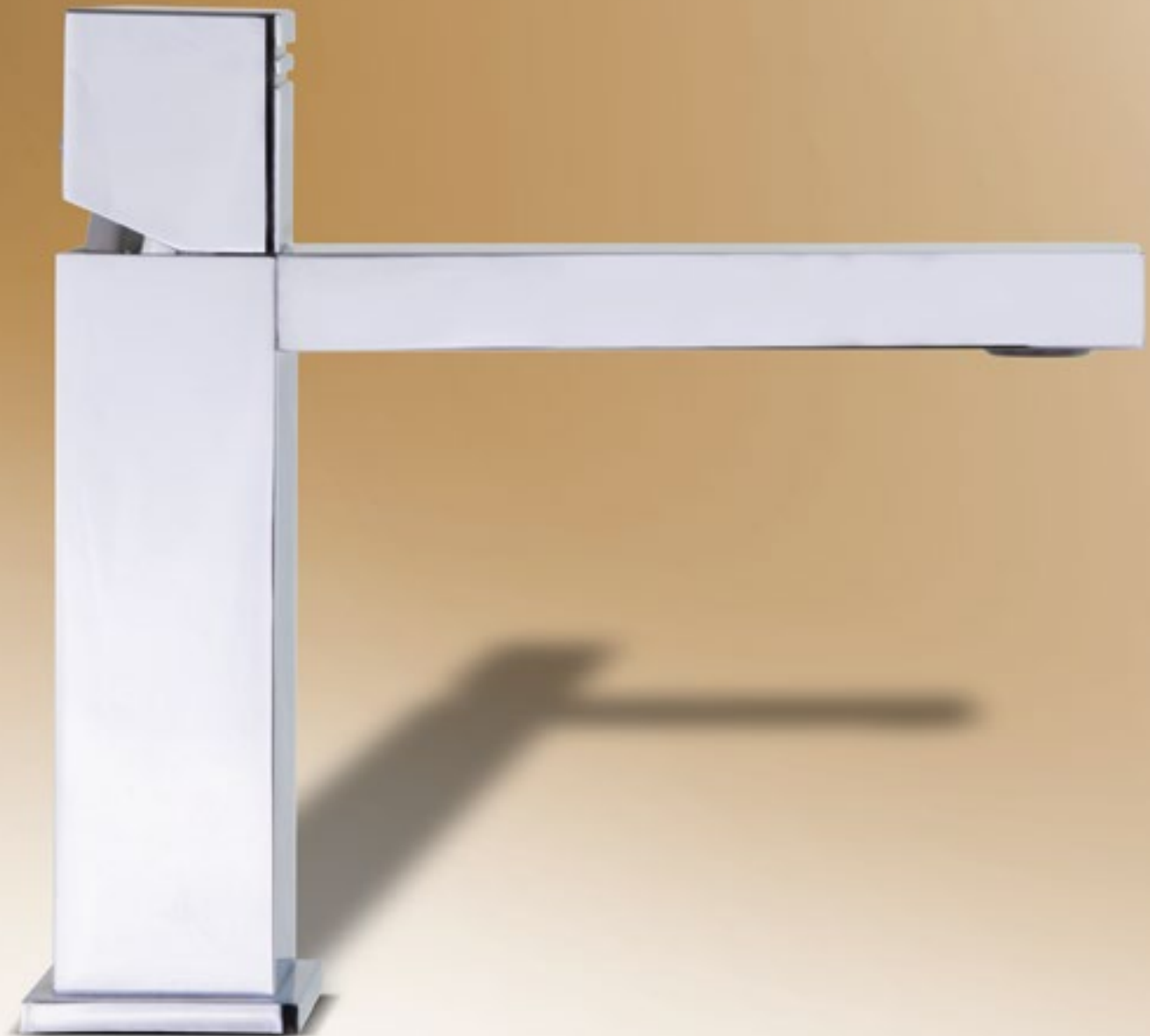

## Características Técnicas

- Cartuchos cerámicos monomando: Ø25mm en Lavabos, Bidet y Fregadero gran cocina, Ø35mm en Baño-Ducha y Ducha, Ø35mm en tanto visto como en empotrado, conjunto monomando repisa y columna baño.
- Cartucho termostático con Sistema Hot Block de seguridad antiquemaduras y Sistema Termostop de bloqueo de la temperatura a 38°.
- Caudal a 3 bar: Lavabo (9 l/min). Ducha (10 l/min). Baño-ducha (12 l/min).
- Prestaciones de confort a nivel de fidelidad, sensibilidad y constancia en la selección de la temperatura.
- Nivel acústico a 3 bar < 20 dB.
- Cromado latón: 15 micras de espesor de níquel, 0,3 micras de cromo.
- Presión de uso entre 1-5 bar, recomendada 3 bar. Resiste presiones estáticas ≤ 10 bar y golpes de ariete de 25 bar.
- Temperatura recomendada de agua caliente 55°C. Temperatura máxima de uso 65°C. Máximo 1h a 90°C.
- Resistente al choque térmico y químico anti-legionela.

## Technical Characteristics

- Ceramic mixer tap cartridge: Ø25mm for washbasins, bidets and sinks in large kitchens, Ø35mm for baths-showers and showers embedded baths-showers, embedded showers, Ø35mm for shelf mixer tap set
- Thermostatic cartridge with Hot Block anti-burn system and Termostop temperature blocking system (to 38°C).
- Flow rate at 3 bars: Washbasin (9 l/min.); Shower (10 l/min.) and; Bath-shower (12 l/min.).
- Comfortable performance as regards reliability, sensitivity and steadiness in the temperature selection.
- Acoustic level at 3 bars: < 20 dB.
- Chrome-plated brass: 15 microns thick of nickel, 0.3 microns of chrome.
- Working pressure between 1-5 bars, recommended: 3 bars. It resists static pressures ≤ 10 bars and water hammers of 25 bars.
- Recommended temperature for the hot water: 55°C. Maximum working temperature: 65°C. Maximum: 1h at 90°C.
- Resistant to thermal and anti-Legionella chemical shocks.

## Acabados disponibles Finishing availables





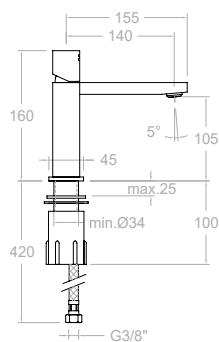

**4702**

241152

187,70 €



**Monomando de lavabo.**  
Wash basin mixer.

Cartucho Cartridge: 25000-2 (4750)

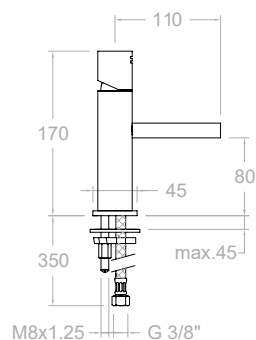

**4731**

229497

394,20 €



**Monomando de lavabo, con caño abierto salida cascada, caudal limitado 4 l/min.**  
Wash basin mixer with cascade stream flow limited 4 l/min.



**3794\***

AAZ301450

18,10 €

**Llave de paso con filtro.**  
Stopcock with filter.

\* INCLUIDA 3794 (x2).

\* INCLUDED 3794 (x2)

Cartucho Cartridge: 25000-2 (4750)

Kuatro  
Kuatro NK

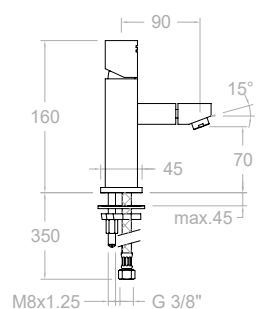

**4703**

212010

222,20 €



**Monomando de bidé.**  
Bidet mixer.

Cartucho Cartridge: 25000-2 (4750)

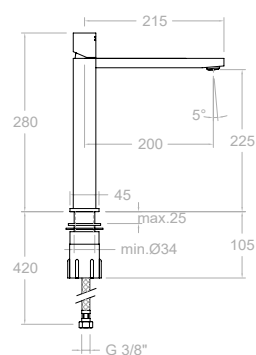

**4710N**

241179

232,50 €



**Monomando de lavabo (L).**  
High wash basin mixer (L).

Cartucho Cartridge: 25000-2 (4750)

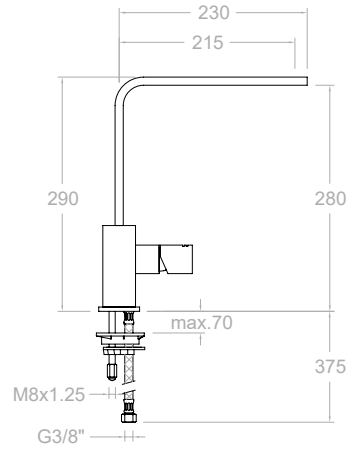

**4729**  
222270

376,30 €



Monomando de lavabo o fregadero con caño giratorio.  
Washbasin or sink mixer with swivel spout.

Cartucho Cartridge: 25000-2 (4750)

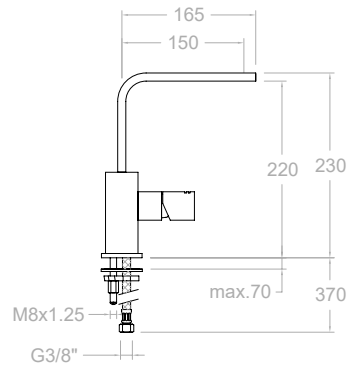

**4721**  
222297

366,80 €



Monomando para lavabo, de caño alto giratorio.  
Wash basin mixer with high swivel spout.

Cartucho Cartridge: 25000-2 (4750)

Recomendaciones Recommendations



**4719L**  
213477

35,30 €

Valvula de latón para desague sistema CLICK CLACK.  
CLICK CLACK waste brass.

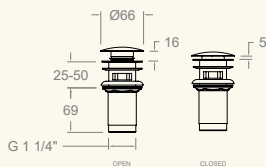

**4790**  
212118

298,10 €

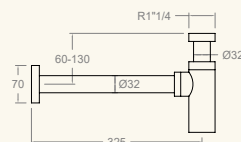

**4788**  
212109

49,60 €

Llave de paso.  
Angle valve.

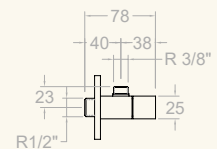



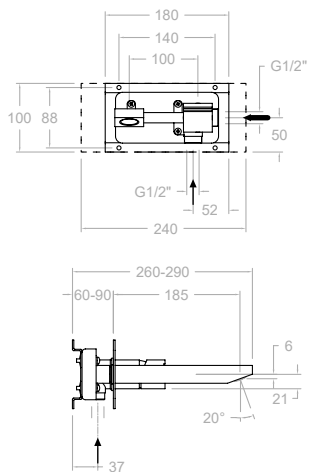
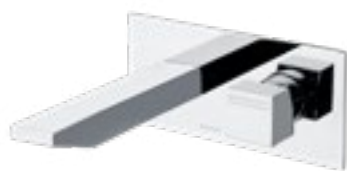

**4720**  
47A300682

334,10 €

Monomando de lavabo empotrado mural con placa.  
Concealed wash basin mixer.



Cartucho Cartridge: 35100-2

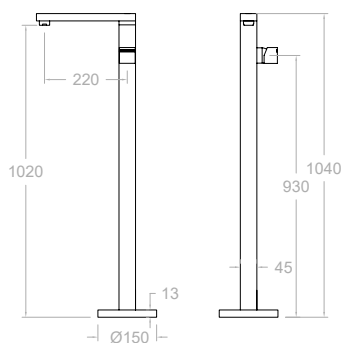

**477602S**  
47A303373

1.418,90 €

Monomando lavabo de columna.  
Washbasin column mixer.



Cartucho Cartridge: 35000-2

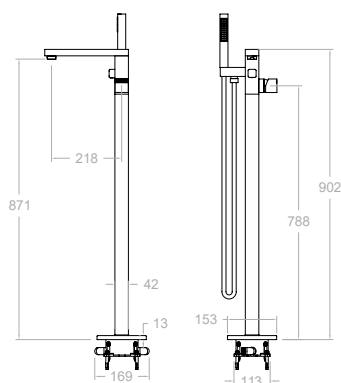

**478502S**  
47C303364

1.734,30 €

Columna monomando para bañera.  
Free standing bath shower column.



**478502MK**  
47C303365

1.841,30 €

Columna monomando para bañera con equipo de ducha.  
Free standing bath shower column with shower set.

478502S + 4713MK + 2471C

Cartucho Cartridge: 35000-2

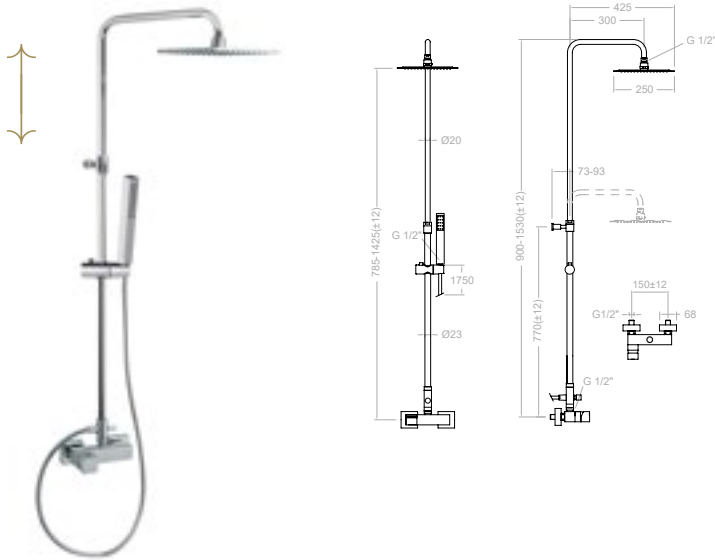

**4758RK250**  
257235

802,30 €

Columna de ducha monomando, telescópica con equipo de ducha metálico.

Single-lever shower column with metallic shower kit.



Cartucho Cartridge: 35000-2 (3760)

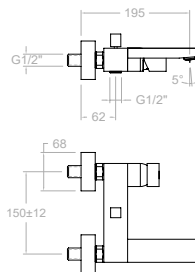

**4725S**  
241197

277,50 €

Monomando de baño-ducha sin equipo de ducha.

Bath and shower mixer without shower kit.



Cartucho Cartridge: 35000-2 (3760)



**4725MK**  
257172

384,10 €

4725 S+4713MK+4726M+2471C

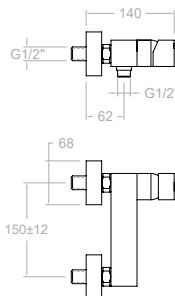

**4728S**  
241215

225,20 €

Monomando de ducha sin equipo de ducha.

Shower mixer without shower kit.



Cartucho Cartridge: 35000-2 (3760)



**4728MK**  
257181

331,80 €

Monomando de ducha con equipo de ducha metálico.

Shower mixer with shower kit.



4725 S+4713MK+4726M+2471C







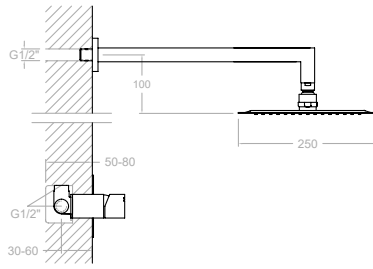

**K4718012**  
47D301359

442,80 €

Conjunto monomando empotrado 1 vía con rociador metálico 250x250 mm.  
Shower set with concealed single lever 1 way mixer, metallic headshower 250x250 mm.



Cartucho Cartridge: 35100 (6689-2)

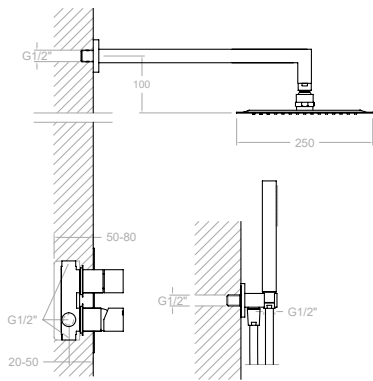

**K4715021**  
47C301360

670,70 €

Conjunto monomando empotrado 2 vías con soporte, toma de agua, teleducha y rociador metálico mura 250x250 mm.  
Shower set with concealed single lever 2 ways mixer, water outlet, handshower, metallic headshower 250x250 mm.



Cartucho Cartridge: 35100 (6689-2)+4004



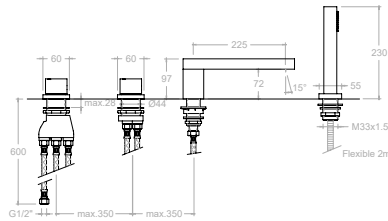

**4733TMK**  
256065

1.629,90 €

Termostático de baño- ducha de repisa con equipo de ducha metálico.  
Thermostatic deck-mounted bath shower mixer with metallic shower set.



Cartucho Cartridge: 1700 TE + 4000

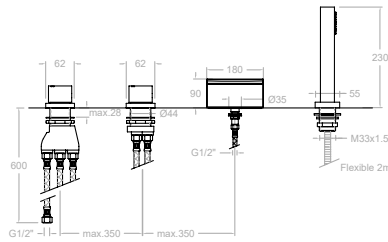

**473303TMK**  
47C302911

1.877,70 €

Termostático de baño- ducha de repisa con caño cascada y equipo de ducha metálico.  
Thermostatic deck-mounted bath shower mixer with metallic shower set and cascade spout.



Cartucho Cartridge: 1700 TE + 4000

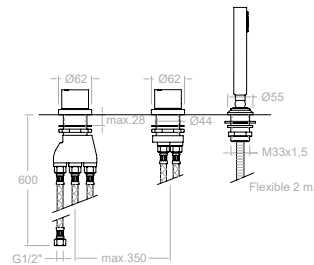

**4733TSCAMK**  
256074

1.114,90 €

Termostático de ducha de repisa con equipo de ducha metálico.  
Thermostatic deck-mounted shower mixer.



Cartucho Cartridge: 1700 TE + 4000

Recomendaciones Recommendations

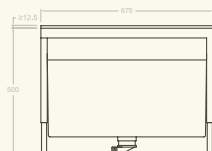

**100502**  
AAZ302174

699,00 €

Repisa extraíble con depósito para el agua de conjunto baño.  
Mounting block with heightadjustable panel and tube box for bath deck (included).

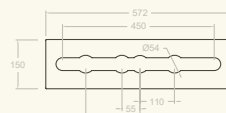

**100502R**  
AAZ302626

204,70 €

Repisa soporte para conjunto baño.  
Mounting plate for bath deck.



**4736S**

539,30 €

215304



Termostático de baño-ducha, sin equipo de ducha.  
Thermostatic bath and shower mixer without a shower set.

Cartucho Cartridge: 4760T + 1700 C1/2"



**MK**

**4736MK**

645,80 €

257280



Termostático de baño-ducha, con equipo de ducha metálico.  
Thermostatic bath and shower with metal shower set.

4736 S+4713MK+4726M+2471C



**4734S**

439,20 €

215295



Termostático de ducha sin equipo de ducha.  
Thermostatic shower mixer without shower kit.

Cartucho Cartridge: 4760T + 1700 C1/2"



**MK**

**4734MK**

545,30 €

257271



Termostático de ducha con equipo de ducha metálico.  
Thermostatic shower mixer with metal shower set.

4734 S+4713MK+4726M+2471C



**4754RK250**

1.086,00 €

257289



Conjunto termostático gran ducha con columna telescópica accesorios metálicos.

Thermostatic shower column, adjustable height.

Cartucho Cartridge: 4760T + 1700 C1/2"

**4742S**

508,90 €

225168



Termostático para gran ducha sin equipo ducha.

Thermostatic mixer without shower kit.

Cartucho Cartridge: 4760T + 1700 C1/2"

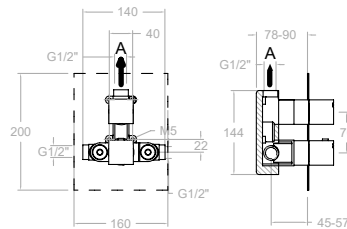

**472411S**  
47D302531

201,00 €

Termostático de ducha empotrado 1 vía con placa metálica.  
Thermostatic concealed mixer 1 way with ultraslim metallic plate.



**1 Vía/Way**

XX1801	1bar	3bar	5bar
A l/min	17	26	34
Kit de ampliación - Extension set: KAET104			

Cartucho Cartridge: 1703T + 1700C3/4"

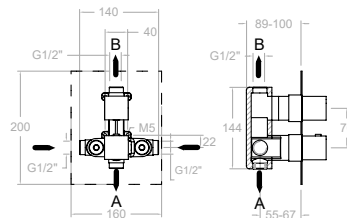

**478712S**  
47D302540

281,30 €

Termostático de baño-ducha empotrado 2 vías con placa metálica extraplana.  
Thermostatic concealed mixer 2 ways with ultraslim metallic plate.



**2 Vías/Ways**

XX1801	1bar	3bar	5bar
A l/min	17	26	34
B l/min	13	22	28
Kit de ampliación - Extension set: KAET103			

Cartucho Cartridge: 1703T + 4000

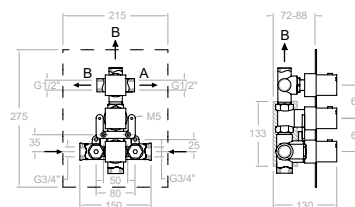

**4723S**  
227706

986,00 €

Termostático de baño-ducha empotrado 3 vías con placa metálica extraplana.  
Thermostatic concealed mixer 3 ways with ultraslim metallic plate.



**3 Vías/Ways**

ETDI	CARTUCHO GRAN CAUDAL 1700 TE		
	1bar	3bar	5bar
A l/min	13,5	23,3	30,2
B l/min	9,3	15,5	19,2
Kit de ampliación - Extension set: KAETDI			

Cartucho Cartridge: 1700TE + 1700C3/4" + 1000I

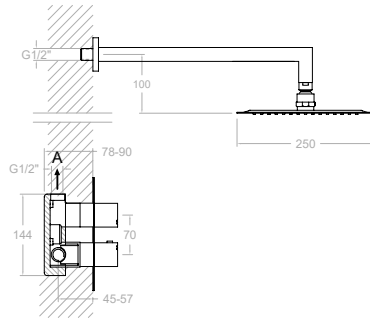

**K4724012**  
47D302765

514,80 €

Conjunto termostático empotrado 1 vía con rociador metálico ø 250 mm.  
Shower set with thermostatic 1 way mixer, water outlet, handshower, metallic headshower ø 250 mm.



Cartucho Cartridge: 1703TE + 1700C3/4"

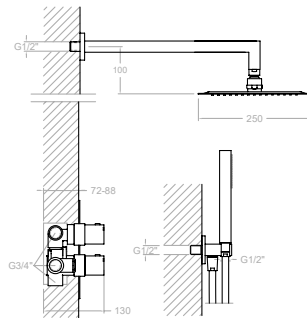

**K4787011**  
47D302766

717,40 €

Conjunto termostático empotrado 2 vías con soporte, toma de agua, teleducha y rociador metálico ø 250 mm.  
Shower set with thermostatic 2 ways mixer, water outlet, handshower, metallic headshower ø 250 mm.



Cartucho Cartridge: 1703T+4000

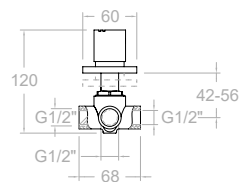

**4737**  
212145

276,80 €

Inversor de 3 vías, mural.  
3 way diverter.  
Cartucho Cartridge: 1000 I

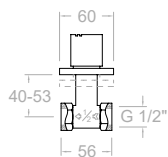

**47071/2X1**  
214539

160,60 €

Llave de paso de 1/2\".  
1/2" angle valve.  
Montura Head: 5000

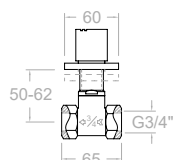

**47073/4X1**  
214593

183,00 €

Llave de paso de 3/4\".  
3/4" angle valve.  
Montura Head: 6000

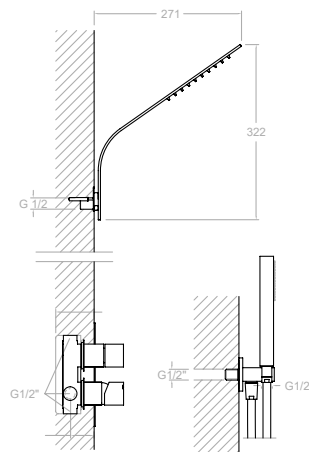
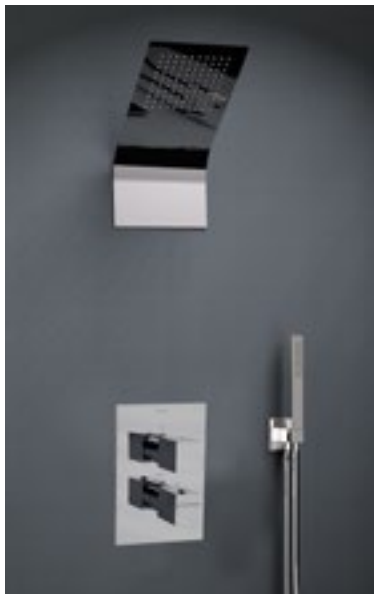

**SK4787011** 403,60 €  
 47D302767  
 478712S + 4713MK + 2471C + 4796

+

**RIKS** 911,00 €  
 99Z300707

Conjunto termostático empotrado 2 vías con rociador metálico mural, soporte más toma de agua y teleducha metálica.  
 Concealed thermostatic 2 ways with metal wall shower head and metal hand shower.

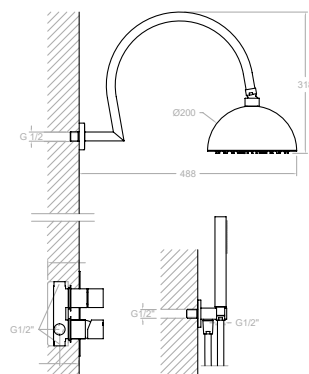
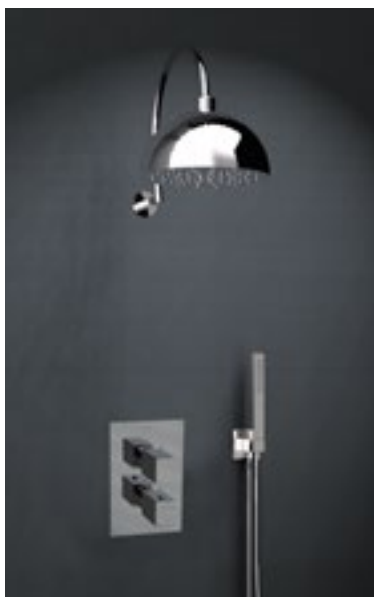

**SK4787011** 403,60 €  
 47D302767  
 478712S+4713MK+4796+2471C

+

**RB2A390** 875,50 €  
 99H300748

Conjunto termostático empotrado 2 vías con soporte más toma de agua, teleducha metálica y rociador redondo Ø 200 mm de acero inoxidable con brazo mural.  
 Concealed thermostatic 2 ways with metal hand shower and round stainless steel shower head Ø 200 mm with wall arm.

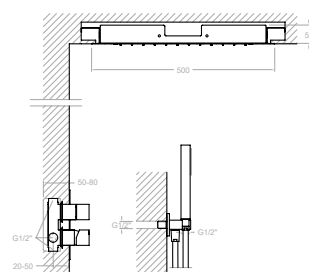
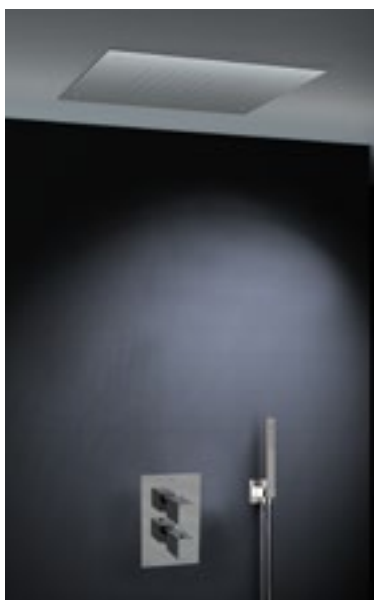

**SK4787011** 403,60 €  
 47D302767  
 478712S + 4713MK + 2471C + 4796

+

**REK500** 1.033,20 €  
 99Z300714

Conjunto termostático empotrado 2 vías con rociador metálico empotrado, soporte más toma de agua y teleducha metálica.  
 Concealed thermostatic 2 ways with concealed ceiling metal shower head, support plus water intake and metal hand shower.





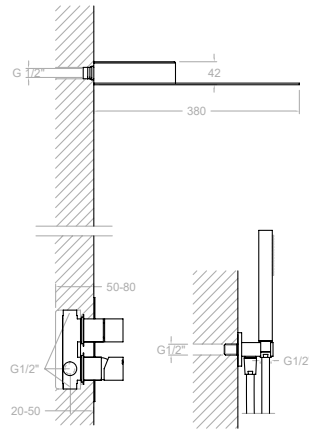

**SK4787011**

47D302767

478712S + 4713MK + 2471C + 4796

403,60 €

+

**RC**

99Z300698

489,60 €

Conjunto termostático empotrado 2 vías con rociador metálico mural salida cascada, soporte más toma de agua y teleducha metálica.

Concealed thermostatic 2 ways with concealed ceiling metal shower head, support plus water intake and metal hand shower.

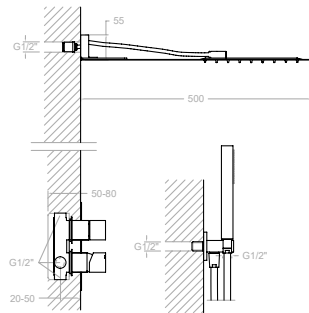

**SK4787011**

47D302767

478712S + 4713MK + 2471C + 4796

403,60 €

+

**RRK**

99Z300709

791,20 €

Conjunto termostático empotrado 2 vías con rociador metálico mural, soporte más toma de agua y teleducha metálica.

Concealed thermostatic 2 ways with concealed ceiling metal shower head, support plus water intake and metal hand shower.

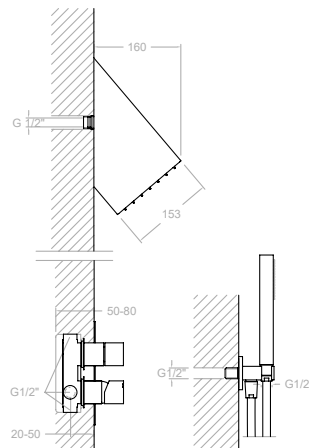
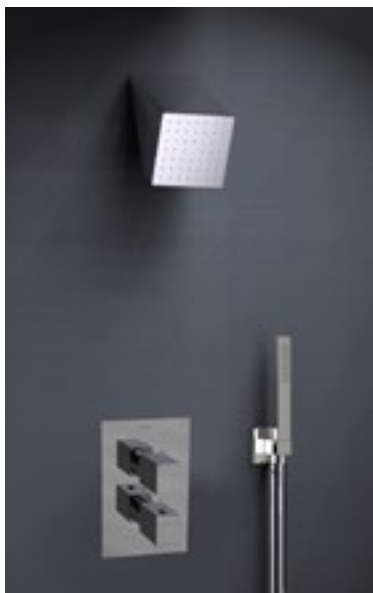

**SK4787011**

47D302767

478712S + 4713MK + 2471C + 4796

403,60 €

+

**RIK**

99Z300703

740,80 €

Conjunto termostático empotrado 2 vías con rociador metálico mural.

Concealed thermostatic 2 ways with metal wall shower head and metal hand shower.



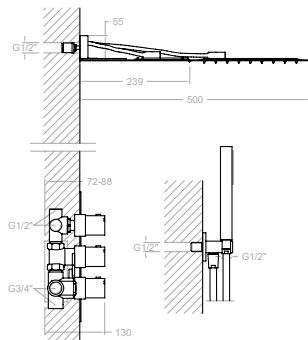
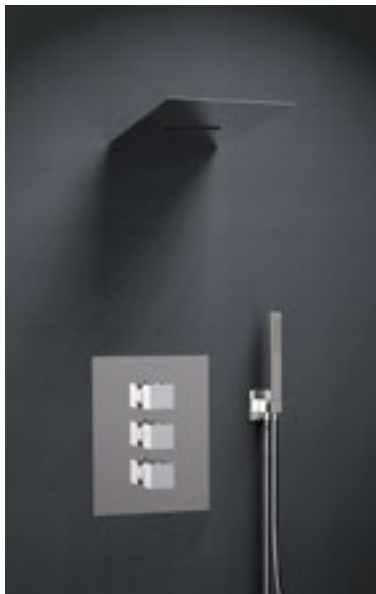

**SK4723001**

47C301412

4723S + 4713MK + 2471C + 4796

1.108,40 €



+

**RCRK**

99Z300708

1.044,30 €



Conjunto termostático empotrado 3 vías con rociador metálico mural salida lluvia ó cascada, soporte más toma de agua y teleducha metálica.

Concealed thermostatic 3 ways with metal wall shower head rain or waterfall effect and metal hand shower.

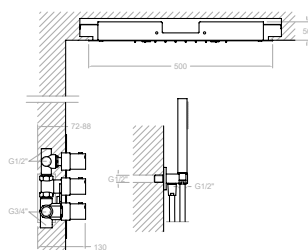
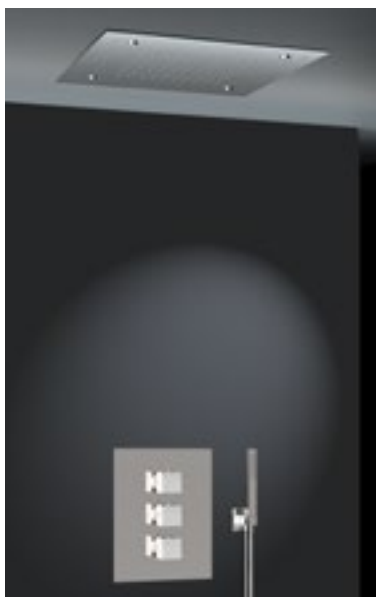

**SK4723001**

47C301412

4723S + 4713MK + 2471C + 4796

1.108,40 €



+

**RELNK500**

99Z300715

1.291,60 €



Conjunto termostático empotrado 2 vías con rociador metálico empotrado con salida lluvia ó nebulizador, soporte más toma de agua y teleducha metálica.

Concealed thermostatic 2 ways with concealed ceiling metal shower head with rain or nebulizer effect and metal hand shower.

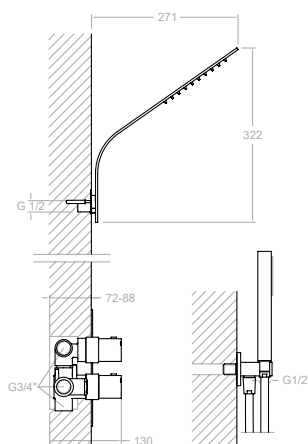
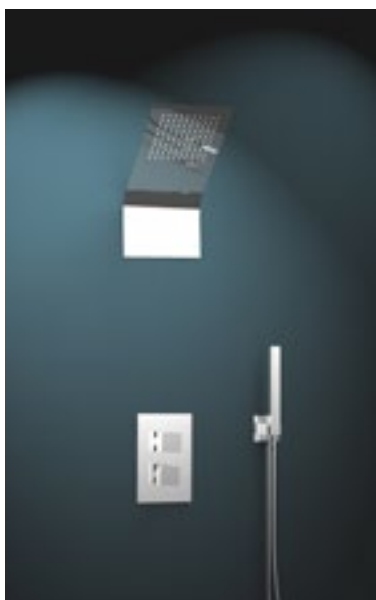

**SK4715021**

47C301406

471502S + 4713MK + 2471C + 4796

357,00 €



+

**RIKS**

99Z300707

911,00 €



Conjunto monomando empotrado 2 vías con rociador metálico mural, soporte más toma de agua y teleducha metálica.

Concealed single mixer lever 2 ways with metal wall shower head, wall elbow hand shower support and metal hand shower.



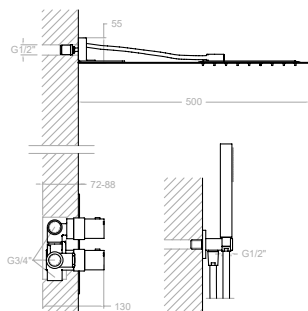
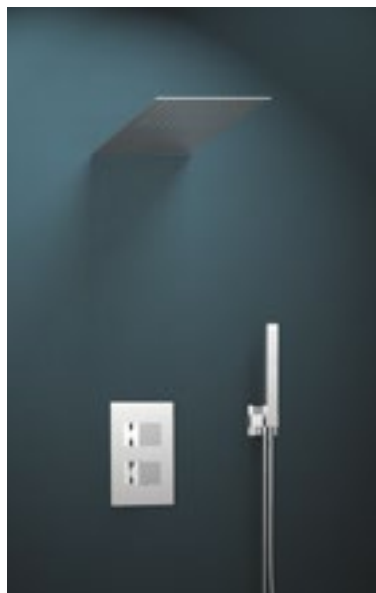

**SK4715021** 357,00 €  
 47C301406  
 471502S + 4713MK + 2471C + 4796

+

**RRK** 791,20 €  
 99Z300709

Conjunto monomando empotrado 2 vías con rociador metálico mural, soporte más toma de agua y teleducha metálica.  
 Single lever 2 ways concealed with metal wall shower head, support plus water intake and metal hand shower.

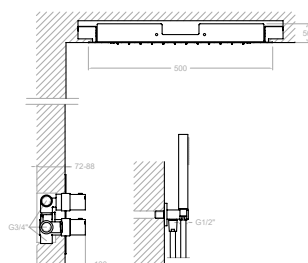
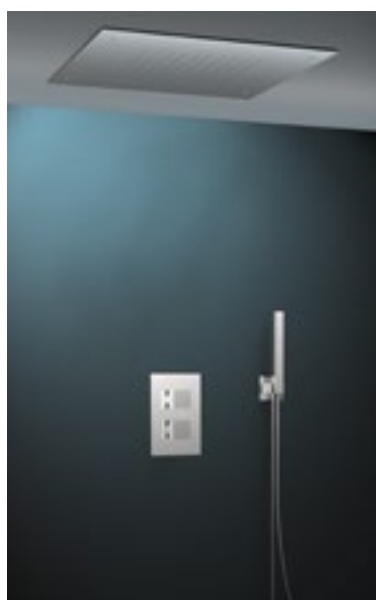

**SK4715021** 357,00 €  
 47C301406  
 491502S + 4713MK + 2471C + 4796

+

**REK500** 1.033,20 €  
 99Z300714

Conjunto monomando empotrado 2 vías con rociador metálico empotrado 500x500 mm.  
 Single lever 2 ways concealed with metal wall shower head 500x500 mm.

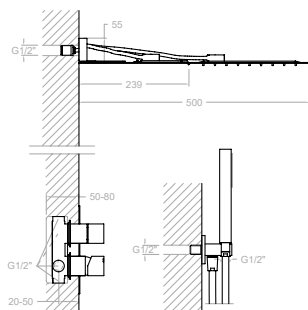
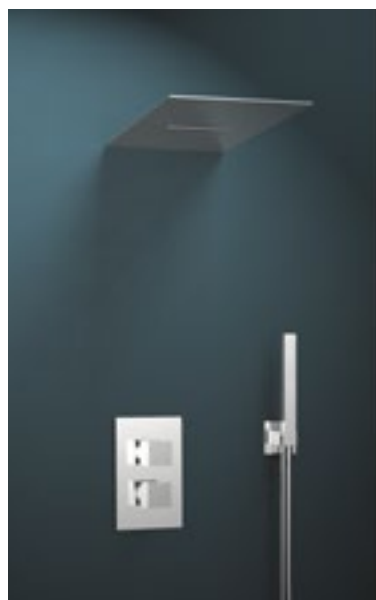

**SK4715031** 406,00 €  
 47C301409  
 471503S + 4713MK + 2471C + 4796

+

**RCRK** 1.044,30 €  
 99Z300708

Conjunto monomando empotrado 3 vías con rociador metálico mural efecto lluvia ó cascada, soporte más toma de agua y teleducha metálica.  
 Single lever 3 ways concealed with metal wall shower head with rain or waterfall effect, support plus water intake and metal hand shower.



# Kuatro NK

Colección Collection



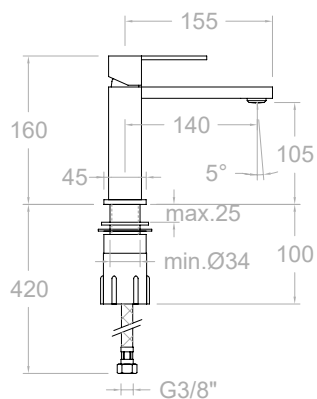

**4902**  
240117

187,70 €

Monomando para lavabo.  
Wash basin mixer.



Cartucho Cartridge: 25000-2 (4750)

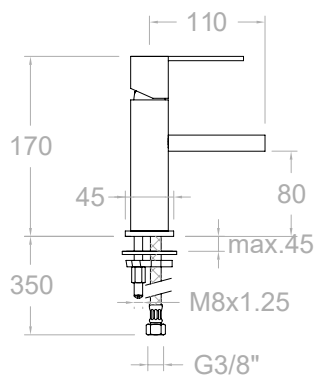

**4931**  
229506

394,20 €

Monomando para lavabo, con caño de cascada con limitador  
4 l/min.  
Wash basin mixer with cascade stream. Flow limited 4 l/min.



**3794\***  
AAZ301450

18,10 €

Llave de paso con filtro.  
Stopcock with filter.

\* INCLUIDA 3794 (x2).  
\* INCLUDED 3794 (x2)

Cartucho Cartridge: 25000-2 (4750)

Cartucho Cartridge: 25000-2 (4750)

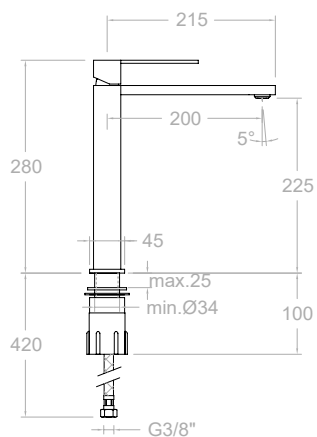

**4910**  
240135

232,50 €

Monomando para lavabo alto. Limitador a 8 l/min.  
High wash basin mixer. Flow limited 8 l/min.



Cartucho Cartridge: 25000-2 (4750)

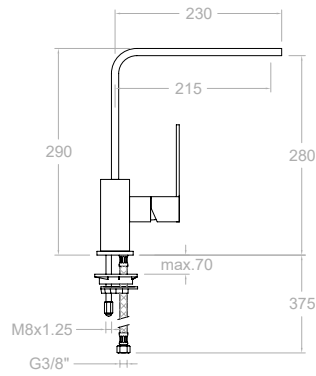

**4929**

223359

376,30 €



Monomando de lavabo o fregadero con caño giratorio.  
Washbasin or sink mixer with swivel spout.

Cartucho Cartridge: 25000-2 (4750)

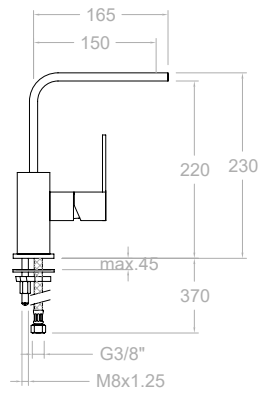

**4921**

223215

366,80 €



Monomando para lavabo, de caño alto giratorio.  
Wash basin mixer with high swivel spout.

Cartucho Cartridge: 25000-2 (4750)

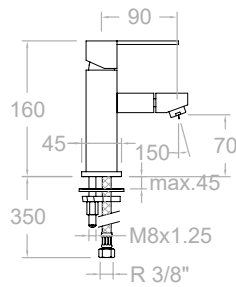

**4903**

223305

222,20 €



Monomando bidé.  
Bidet mixer.

Cartucho Cartridge: 25000-2 (4750)



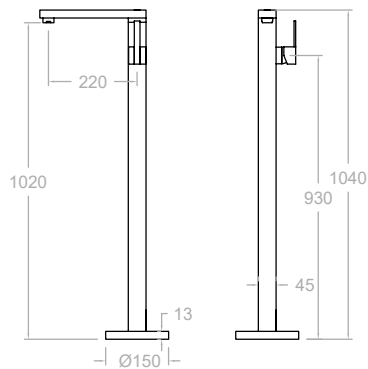

**497602S**  
49A303392

1.418,90 €

Monomando de columna para lavabo.  
Washbasin column mixer.



Cartucho Cartridge: 35100-2

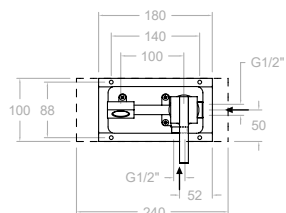

**4920**  
49A300683

334,10 €

Monomando para lavabo empotrado caño 19 mm.  
Concealed wash basin mixer spout 19 mm.

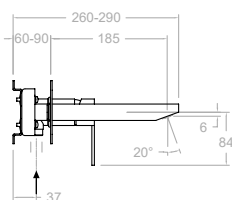

Cartucho Cartridge: 35100-2

Recomendaciones Recommendations



**4719L**  
213477

35,30 €

Valvula de latón para desagüe sistema CLICK CLACK.  
CLICK CLACK waste brass.

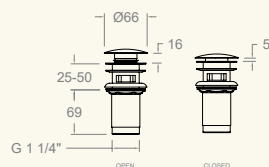

**4790**  
212118

298,10 €

Sifón latón.  
Brass siphon.

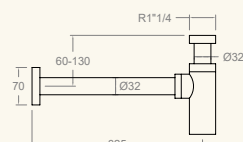

**4788**  
212109

49,60 €

Llave de paso.  
Angle valve.

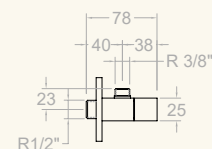

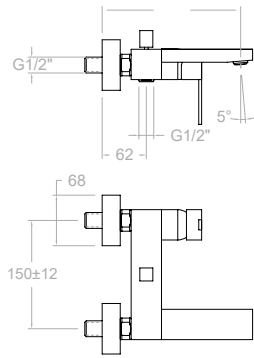

**4925S**  
240144

277,50 €

Monomando de baño - ducha sin equipo de ducha.  
Bath and shower mixer without shower kit.



Cartucho Cartridge:35000-2 (3760)



**MK**

**4925MK**  
256911

384,10 €

Monomando de baño - ducha sin equipo de ducha.  
Bath and shower mixer without shower kit.



4925S+4713MK+4726M+2471C

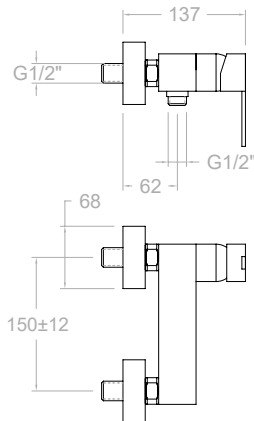

**4928S**  
240153

225,20 €

Monomando de ducha sin equipo de ducha.  
Shower mixer without shower kit.



Cartucho Cartridge:35000-2 (3760)



**MK**

**4928MK**  
256920

331,80 €

Monomando de baño - ducha con equipo de ducha.  
Bath and shower mixer with shower kit.



4928 S+4713MK+4726M+2471C

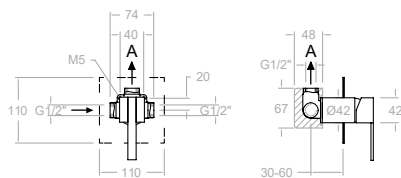

**491801S**  
49D300649

129,00 €



Conjunto monomando de ducha empotrado 1 vía con placa metálica y sin equipo ducha.  
Single lever 1 way concealed shower valve with metallic plate, without shower kit.

**1 Vía/Way**

XX1801	1bar	3bar	5bar
A l/min	17	26	34
Kit de ampliación - Extension set: KA1V			

Cartucho Cartridge: 35100 (6689-2)

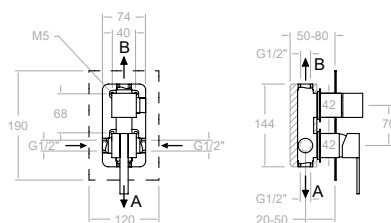

**491502S**  
49C300650

234,60 €



Conjunto monomando de bañoducha empotrado 2 vías con placa metálica sin equipo ducha.  
Single lever 2 way concealed bathshower valve with metallic plate without shower kit.

**2 Vías/Ways**

XX1502	1bar	3bar	5bar
A l/min	14	24	30
B l/min	13	22	29
Kit de ampliación - Extension set: KA2V			

Cartucho Cartridge: 35100 (6689-2)+ 4004

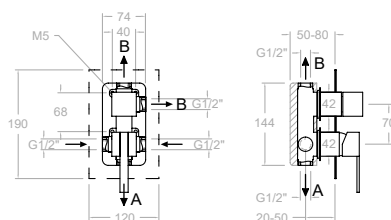

**491503S**  
49C300651

283,70 €



Conjunto monomando de bañoducha empotrado 3 vías con placa metálica sin equipo ducha.  
Single lever 3 way concealed bathshower valve with metallic plate without shower kit.

**3 Vías/Ways**

XX1502	1bar	3bar	5bar
A l/min	14	22	28
B l/min	13	21	26
B l/min	13	21	26
Kit de ampliación - Extension set: KA3V			

Cartucho Cartridge: 35100 (6689-2)+ 4003

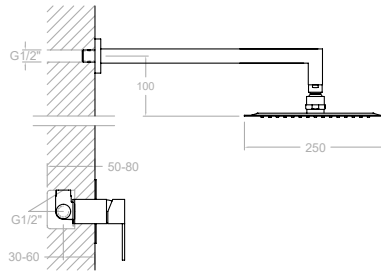

**K4918012**  
49D301370

442,80 €

Monomando empotrado 1 vía con con rociador metálico mural.  
Single lever 1 way concealed bathshower valve with shower head.



Cartucho Cartridge: 35100 (6689-2)

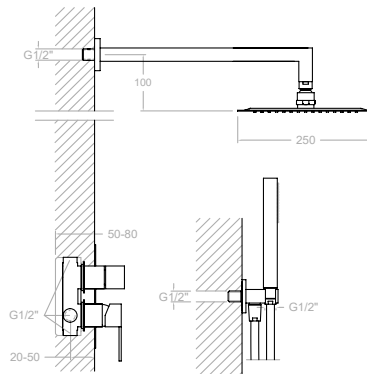
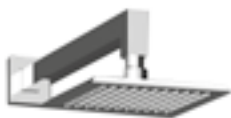

**K4915021**  
49C301371

670,70 €

Kit monomando empotrado 2 vías con soporte más toma de agua y teleducha metálica.  
Single lever 2 way concealed bath-shower valve with shower head and handshower.



Cartucho Cartridge: 35100 (6689-2)+4004

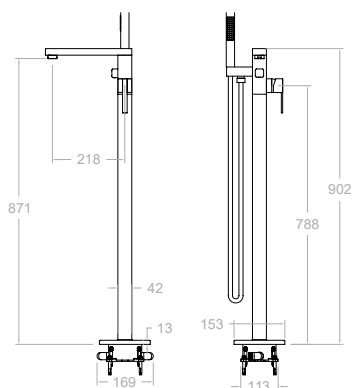

**498502S**

49C303390

1.734,30 €

Monomando de columna para baño sin equipo de ducha.  
Bath mixer without shower kit.

**498502MK**

49C303391

1.841,30 €

Monomando de columna para baño sin equipo de ducha.  
Bath mixer without shower kit.

498502S+ 4713MK + 2471C

Cartucho Cartridge: 35100-2

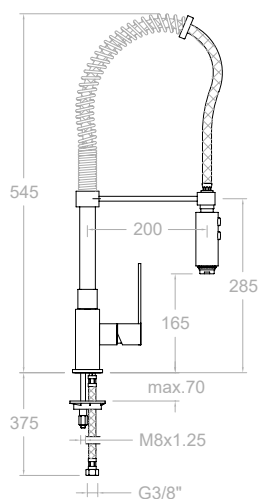

**4966**

223377

710,40 €

Monomando con duchita 2 jets orientable para gran cocina.  
Sink mixer with 2 jets for great kitchens.

Cartucho Cartridge: 25000-2 (4750)

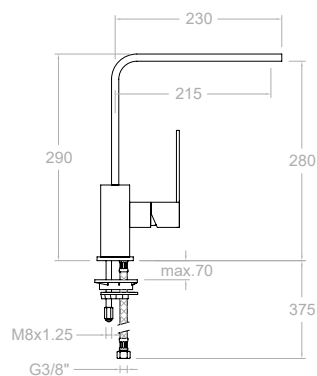

**4929**

223359

376,30 €

Monomando de fregadero con caño giratorio.  
Sink mixer with swivel spout.

Cartucho Cartridge: 25000-2 (4750)



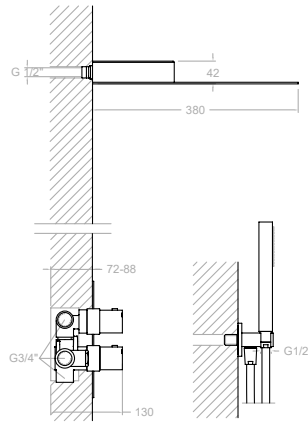
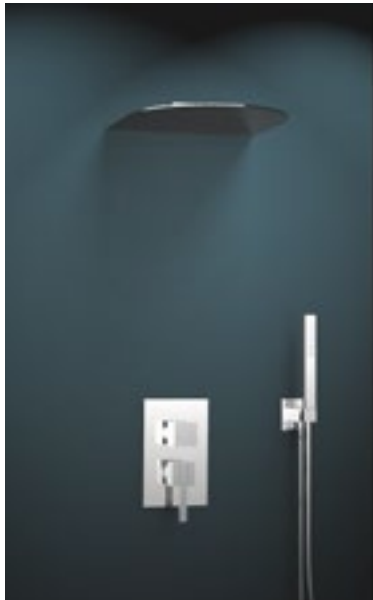

**SK4915021**

49C301414

491502S + 4713MK + 2471C + 4796

357,00 €



+

**RC**

99Z300698

489,60 €

Conjunto monomando empotrado 2 vías con rociador cascada metálico mural.

Single lever 2 ways with meta waterfall wall shower head.

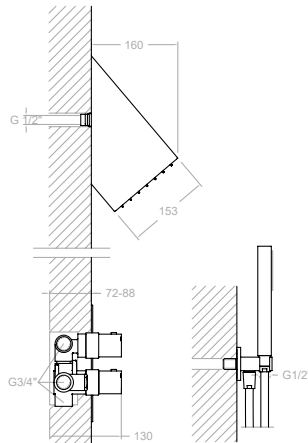
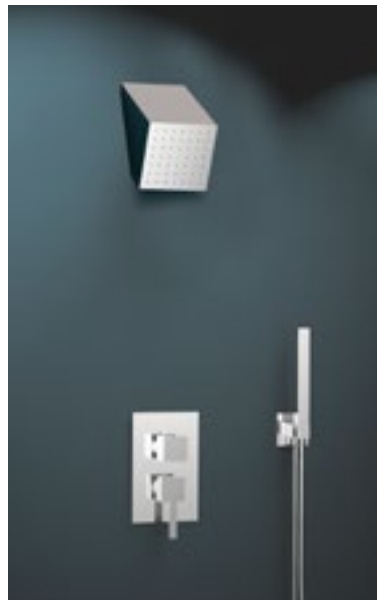

**SK4915021**

49C301414

491502S + 4713MK + 2471C + 4796

357,00 €



+

**RIK**

99Z300703

740,80 €

Conjunto monomando empotrado 2 vías con rociador metálico mural.

Single lever 2 ways with metal wall shower head and metal hand shower.

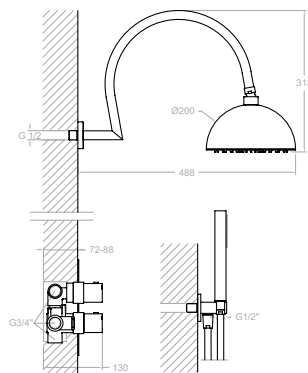
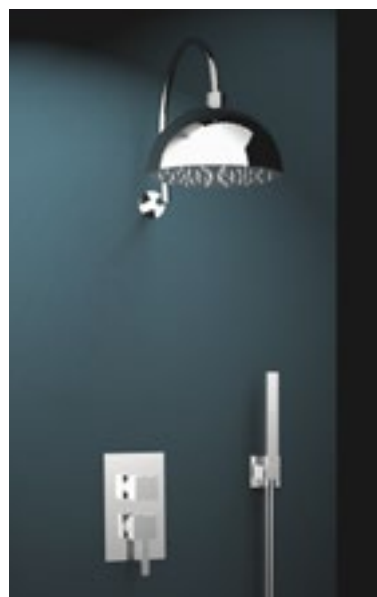

**SK4915021**

49C301414

491502S + 4713MK + 2471C + 4796

357,00 €



+

**RB2A390**

99H300748

875,50 €

Conjunto monomando empotrado 2 vías con soporte más toma de agua, teleducha metálica y rociador redondo Ø 200 mm de acero inoxidable con brazo mural.

Concealed single mixer lever 2 ways with metal hand shower and round stainless steel shower head Ø 200mm with wall arm.



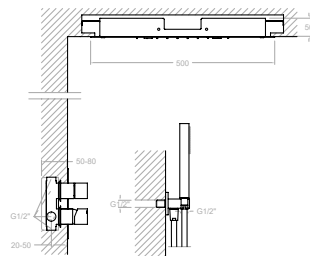
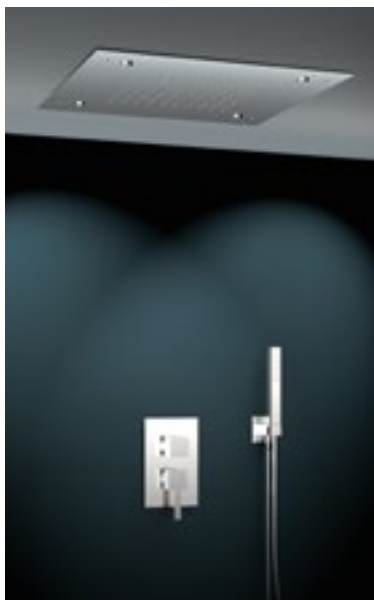

**SK4915021** 406,00 €

49C301414

471503S + 4713MK + 2471C + 4796

+

**RELNK500**

1.291,60 €

99Z300715

Conjunto monomando empotrado 3 vías con rociador metálico empotrado efecto lluvia ó nebulizador, soporte más toma de agua y teleducha metálica.

Single lever 3 ways concealed with metal wall shower head with rain or nebulizer effect, support plus water intake and metal hand shower.



# Drako

Colección Collection



## Características Técnicas

- Ø40 Lavabo alto, Ducha, B/D, Fregadero Italiano y Fregadero abatible.
- Ø35 Lavabo Medio, Bidet, Empotrados (lavabo, B/D, Ducha) y Fregaderos.
- Cartuchos cerámicos monomando con Sistema Termostop Block de limitación de la temperatura máxima del agua caliente y con Sistema de ahorro de agua (S2-C2) mediante la apertura de la manecilla en dos fases.
- Cartucho termostático con Sistema Hot Block de seguridad antiquemaduras y Sistema Termostop de bloqueo de la temperatura a 38°C.
- Caudal a 3 bar: Lavabo, Bidet y Fregadero (de 9 a 12 l/min). Ducha (de 12 a 16 l/min). Baño ( $\geq 20$  l/min)
- Prestaciones de confort a nivel de fidelidad, sensibilidad y constancia en la selección de la temperatura.
- Nivel acústico a 3 bar < 20 dB.
- Cromado latón: 15 micras de espesor de níquel, 0,3 micras de cromo.
- Presión de uso entre 1-5 bar, recomendada 3 bar. Resiste presiones estáticas  $\leq 10$  bar y golpes de ariete de 25 bar.
- Temperatura recomendada de agua caliente 55°C. Temperatura máxima de uso 65°C. Máximo 1h a 90°C.
- Resistente al choque térmico y químico anti-legionela.
- Certificado sanitario ACS.

## Technical Characteristics

- Ø40 High washbasin, shower, bath-shower, Italian sinks, folding sink.
- Ø35 Medium washbasin, bidet, built-in (washbasin, bath-shower, shower), sinks.
- Ceramic mixer tap cartridge with Termostop Block System limiting the maximum temperature of hot water and a water saving system (S2-C2) by a two-phase opening lever.
- Thermostatic cartridge with Hot Block anti-burn system and Termostop temperature blocking system (to 38°C).
- Flow rate at 3 bars: Washbasin, bidet and Wash basin (from 9 to 12 l/min.); Shower (from 12 to 16 l/min.); and Bath ( $\geq 20$  l/min.)
- Comfortable performance as regards reliability, sensitivity and steadiness in the temperature selection.
- Acoustic level at 3 bars: < 20 dB.
- Chrome-plated brass: 15 microns thick of nickel, 0.3 microns of chrome.
- Working pressure between 1-5 bars, recommended: 3 bars. It resists static pressures  $\leq 10$  bars and water hammers of 25 bars.
- Recommended temperature for the hot water: 55°C. Maximum working temperature: 65°C. Maximum: 1h at 90°C.
- Resistant to thermal and anti-Legionella chemical shocks.
- CS health compliance certificate

Acabados disponibles Finishing availables



● Cromo  
Chrome



● Negro mate  
Black matte





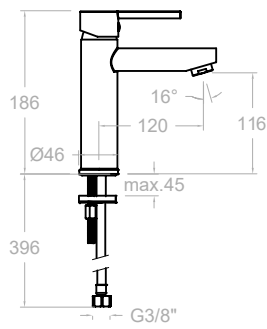

**3304** 33A300822 109,30 € ●

**3304NM** 33A307846 164,00 € ● **N**

Monomando de lavabo (M).  
Washbasin mixer.

**3304VA1169** 33A304403 128,80 € ●

Monomando de lavabo (M), con válvula automática 1/4\"/>



Acabados especiales disponibles en Junio  
Special finishings available in June

Cartucho Cartridge:35100 -3



**Ahorro de energía**  
**Apertura en frío**

Energy saving  
Cold opening



**330403** 33A300846 114,50 € ●

**330403NM** 33A307847 171,80 € ● **N**

Monomando de lavabo (M), apertura en frío.  
Single lever washbasin, system C3 cold opening.

**330403VA1169** 33A304232 134,10 € ●

Monomando de lavabo con válvula automática de inox 1/4\"/>



Cartucho Cartridge:35300 -3

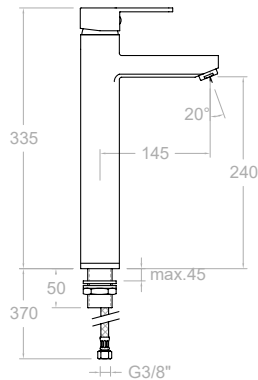

**3310** 218562 205,90 € ●

**3310NM** 33A307848 308,90 € ● **N**

Monomando de lavabo (XL).  
High washbasin mixer (XL).



Cartucho Cartridge:40100 (3388)

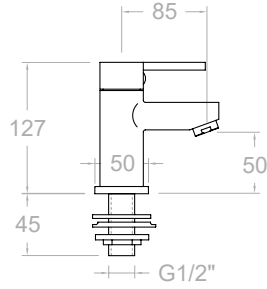

**3371AX1**  
227823

80,30 €

Grifo de lavabo de 1 agua fría (1 unidad).  
Single lever washbasin mixer, 1 water only cold.



Montura Head: 3390F 3/4"

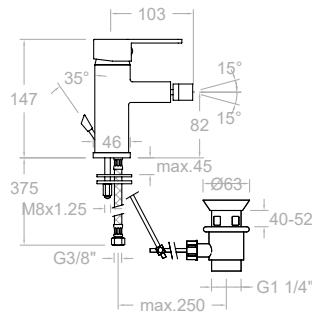

**330302**  
33B302519

109,30 €

**330302NM**  
33B307849

164,00 €

Monomando para bidé.  
Bidet mixer.

**330302VA1169**  
33B304231

128,80 €

Monomando para bide, con válvula automática 1/4".  
Bidet mixer with with stainless steel pop-up waste 1/4".

Ref. 1169



Cartucho Cartridge: 35100-3

Acabados especiales disponibles en Junio  
Special finishings available in June

Recomendaciones Recommendations



**121602P** 16,50 €  
AAZ303592

Sistema CLICK CLACK lavabo en PVC-Inox.  
CLICK CLACK wash PVC-Inox system.

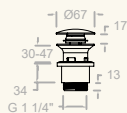

**1219L** 27,40 €  
197106

Valvula de latón para desague sistema CLICK CLACK.  
CLICK CLACK waste brass.

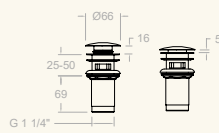

**3790** 65,80 €  
198960

Sifón cromado.  
Bottletrap.

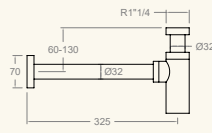

**3788** 16,50 €  
198969

Grifo de escuadra cromado.  
Angle valve.

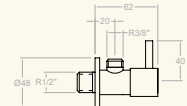



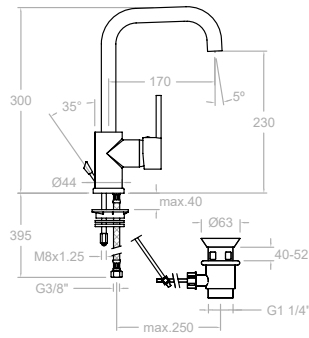

**331102** 112,80 €  
33A301603

Monomando de lavabo, con caño giratorio.  
Washbasin with high swivel spout.

**331102VA1167** 136,60 €  
33A301604

Monomando de lavabo, con caño giratorio con válvula automática 1<sup>1/4</sup>".  
Washbasin with high swivel spout with pop-up waste 1<sup>1/4</sup>".  
Ref. 1167 BRASS

Cartucho Cartridge:35200 (6689)

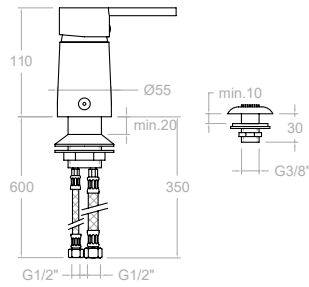

**SA3323** 109,90 €  
215133

Monomando para bidé de repisa con ducha.  
Deck mounted bidet.

Cartucho Cartridge:40100 (3388)



Venta en el  
Continente Americano  
Available in North, Central  
& South America

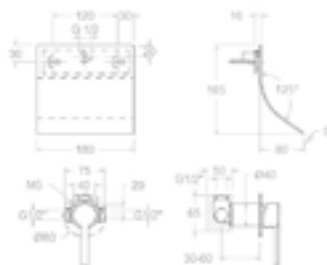

**33169** 557,60 €  
33A300913

Monomando de lavabo empotrado salida cascada.  
Concealed washbasin mixer with cascade spout.

Cartucho Cartridge:35100(6689-2)  
XX1801+3300N-35+169+RB21H

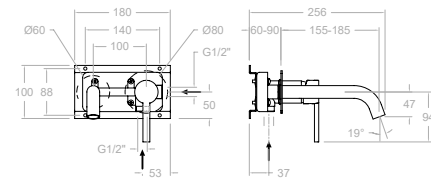

**332102** 236,60 €  
33A300690

Monomando de lavabo empotrado mural con caño de 19 cm.  
Concealed washbasin mixer 19 cm spout.

**332103** 246,90 €  
33A301459

Monomando de lavabo empotrado mural con caño de 24 cm.  
Concealed washbasin mixer 24 cm spout.

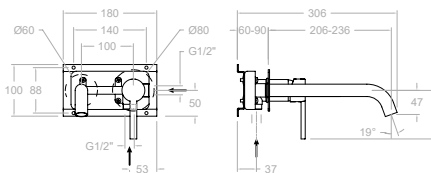

Cartucho Cartridge:35100-2



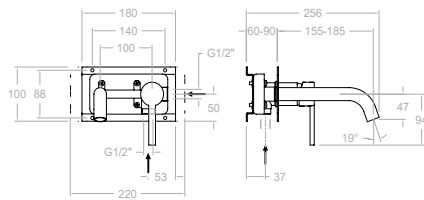

**332002**  
33A300691

236,60 €

Monomando de lavabo empotrado mural con placa metálica y caño 19 cm.  
Single lever concealed washbasin with plate, spout 19cm.

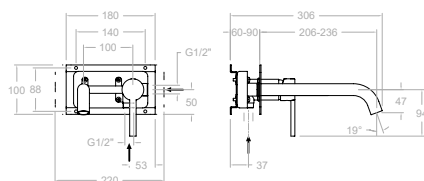

**332003**  
33A301458

246,90 €

Monomando de lavabo empotrado mural con placa metálica y caño 24 cm.  
Single lever concealed washbasin with plate, spout 24cm.

Cartucho Cartridge:35100-2

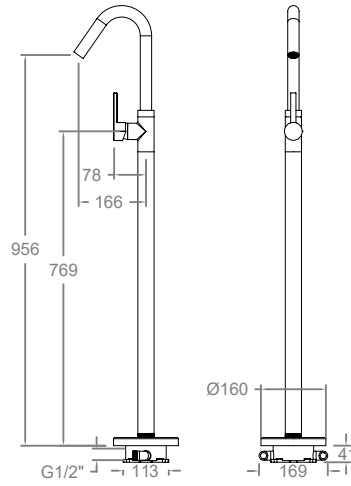

**337602S**  
33A303372

865,80 €

Monomando lavabo de columna.  
Washbasin column mixer.



Cartucho Cartridge: 35001-2

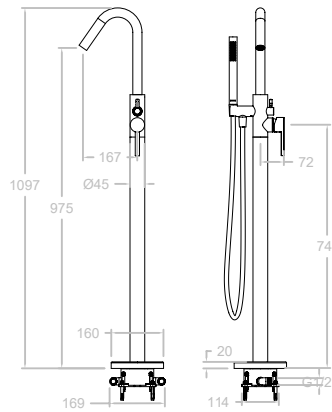

**338503S**  
33C303360

1.176,70 €

Columna monomando para bañera.  
Free standing bath shower column.



**338503MO**  
33C303361

1.281,30 €

Columna monomando para bañera con equipo de ducha metálico.  
Free standing bath shower column with metal shower set.

Cartucho Cartridge: 35001-2  
338503S+3713M+2471C

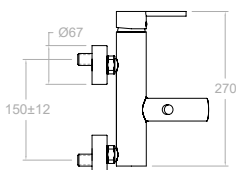
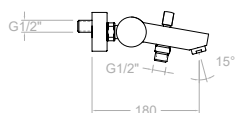

**3305S**  
217221

159,30 €

Monomando de baño - ducha sin equipo de ducha.  
Bath and Shower mixer without shower set.



**T3**



**3305T3**  
257829

209,40 €

Monomando Baño-Ducha con equipo ducha  
Bath and Shower mixer with shower set.

3305 S+5812 T3  
3305S+5840T3+3726+1128C



**D**



**3305D**  
217075

195,50 €

Monomando Baño-Ducha con equipo ducha metálico.  
Bath and Shower mixer with metal shower set.

3305 S+3349 D  
3305S+3713P+3726+1128C

Cartucho Cartridge:40200 (3388KC2)

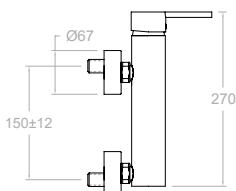
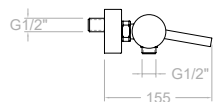

**3308S**  
217230

126,40 €

Monomando de ducha sin equipo de ducha.  
Shower mixer without shower set.



**T3**



**3308T3**  
257847

176,40 €

Monomando de ducha con equipo de ducha.  
Shower mixer with shower set.

3308 S+5812 T3  
3308S+5840T3+3726+1128C



**D**



**3308D**  
217084

162,40 €

Monomando de ducha con equipo de ducha metálico.  
Shower mixer with metal shower set.

3308 S+3349 D  
3308S+3713P+3726+1128C

Cartucho Cartridge: 40200 (3388KC2)





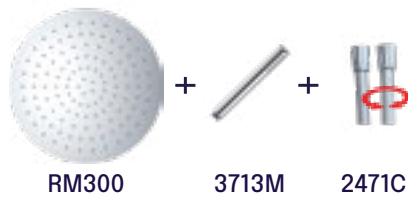
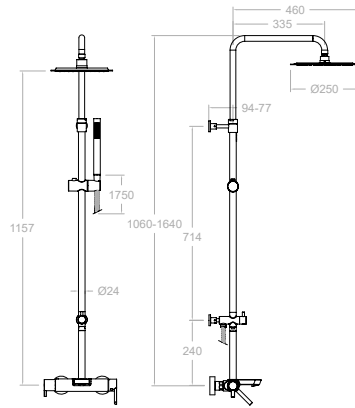

**335502RM250**  
33C303794

986,70 €

Columna de baño-ducha telescópica monomando rociador metálico ø 250 mm.  
Single lever telescopic shower column, chrome metallic headshower ø 250 mm

Cartucho Cartridge: 35200+4004

334602S-DN130D+T18-IDP16-RM250+3713M+2471C

**334602S**  
33C303807

316,20 €

Monomando baño - ducha con inversor integrado.  
Bath shower with integrated diverter.

**335502RM300**  
33C303795

1.043,40 €

Columna de baño-ducha telescópica monomando rociador metálico ø 300 mm.  
Single lever telescopic shower column, chrome metallic headshower ø 300 mm

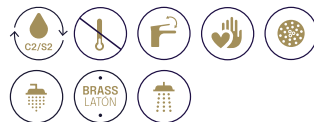

334602S+DN130D+T18-IDP16-RM300+3713M+2471C



**335502RPK225**  
33C303797

848,20 €

Columna de baño-ducha telescópica monomando con accesorios ABS y rociador cuadrado 225 x 225 mm.  
Single lever telescopic shower column with ABS accessories and headshower 225 x 225 mm.

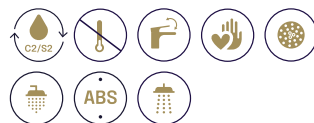

334602S+DN130D+T18-IDP16+RPK225+3713P+2471C

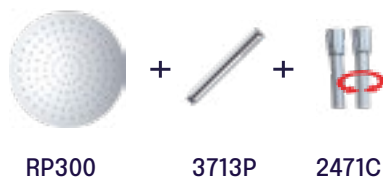

**335502RP300**  
33C303796

848,20 €

Columna de baño-ducha telescópica monomando con accesorios ABS y rociador ø 300 mm.  
Single lever telescopic shower column with ABS accessories and headshower ø 300 mm.



334602S+DN130D+T18-IDP16+RP300+3713P+2471C





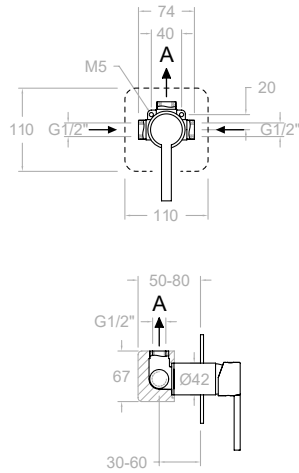

**1 Vía/Way**

Acabados especiales disponibles en Junio  
Special finishings available in June

**331801S** 33D300662 103,90 € ●

**331801SNM** 33D307852 155,90 € ● **N**

Monomando de ducha empotrado 1 vía con placa metálica.  
Single lever concealed mixer 1 way with ultraslim metallic plate.

XX1801	1bar	3bar	5bar
A l/min	17	26	34

Kit de ampliación - Extension set: KA1V



Cartucho Cartridge: 35100 (6689-2)

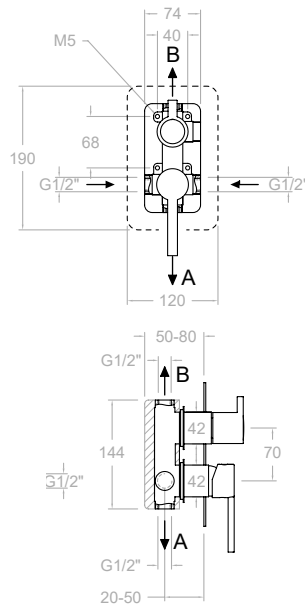

**2 Vías/Ways**

Acabados especiales disponibles en Junio  
Special finishings available in June

**331502S** 33C300664 189,20 € ●

**331502SNM** 33D307850 283,90 € ● **N**

Monomando de ducha empotrado 2 vías con placa metálica.  
Single lever concealed mixer 2 ways with ultraslim metallic plate.

XX1502	1bar	3bar	5bar
A l/min	14	24	30
B l/min	13	22	29

Kit de ampliación - Extension set: KA2V



Cartucho Cartridge: 35100 (6689-2) + 4004

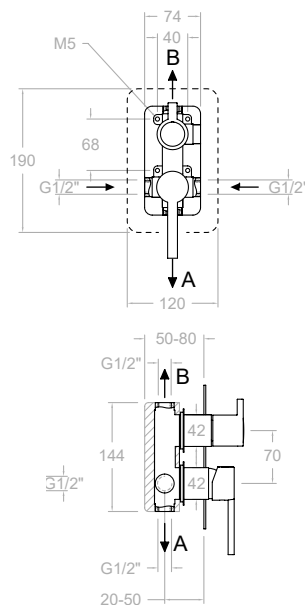

**3 Vías/Ways**

Acabados especiales disponibles en Junio  
Special finishings available in June

**331503S** 33C300665 229,00 € ●

**331503SNM** 33D307851 343,50 € ● **N**

Monomando de ducha empotrado 3 vías con placa metálica.  
Single lever concealed mixer 3 ways with ultraslim metallic plate.

XX1503	1bar	3bar	5bar
A l/min	14	22	28
B l/min	13	21	26
B l/min	13	21	26

Kit de ampliación - Extension set: KA3V



Cartucho Cartridge: 35100 (6689-2) + 4003

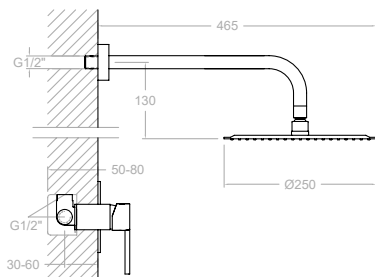

**K3318012**

33D301384

335,60 €

Conjunto monomando empotrado 1 vía con rociador metálico ø 250 mm.

Shower set with concealed single lever 1 way mixer, metallic headshower ø 250 mm.



Cartucho Cartridge: 35100 (6689-2)

331801S+BHRM250

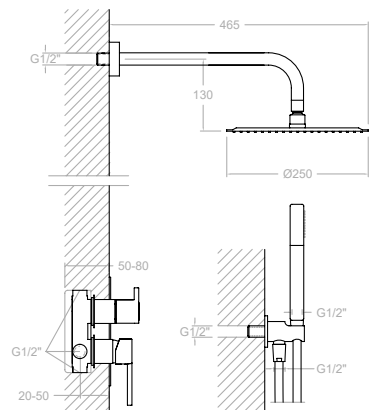

**K3315021**

33C301385

531,40 €

Conjunto monomando empotrado 2 vías con soporte, toma de agua, teleducha y rociador metálico mural ø 250 mm.

Shower set with concealed single lever 2 ways mixer, water outlet, handshower, metallic headshower ø 250 mm,



Cartucho Cartridge: 35100 (6689-2)+4004

331502S+BHRM250+3713M+3796+2471C

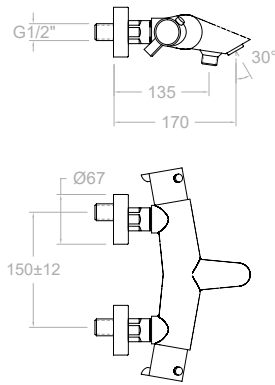

**3339S**  
219453

397,90 €

Termostático de baño - ducha volante distribuidor y regulador de caudal integrado, sin equipo de ducha.  
Thermostatic bath-shower mixer with integrated diverter in flow rate handle without shower set.



Cartucho Cartridge: 4000



**D**

**3339D**  
219444

433,90 €

Termostático de baño - ducha, con equipo de ducha.  
Thermostatic bath-shower mixer, with shower set.



3339S + 3349 D  
3339S-3713P+3726+1128C



**T3**

**3339T3**  
257964

447,80 €

Termostático de baño- ducha, con equipo de ducha.  
Thermostatic bath-shower mixer, with shower set.



3339 S + 5812 T3  
5812 T3 (5840 T3 + 3726 + 1128C)



**AS**

**3339AS**  
241458

463,90 €

Termostático de baño- ducha, con equipo de ducha.  
Thermostatic bath-shower mixer, with shower set.

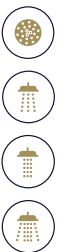

3339 S + 5849 AS  
5849 AS (5811 AS + 3726 + 2471C)

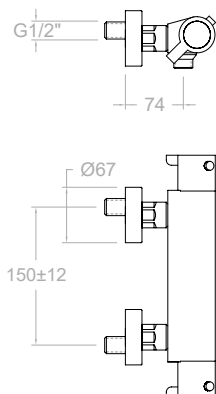

**333402S**

261885

258,90 €

Termostático de ducha sin equipo de ducha.  
Thermostatic shower mixer without shower set.



Cartucho Cartridge: 1701T + 1700C 1/2



**D**

**333402D**

300160

295,10 €

Termostático de ducha, con equipo de ducha.  
Thermostatic bath-shower mixer, with shower set.



333402 S + 3349 D  
3349 D (3713P + 3726 + 1128C)



**T3**

**333402T3**

261887

309,00 €

Termostático de ducha, con equipo de ducha.  
Thermostatic bath-shower mixer, with shower set.



333402 S + 5812 T3  
5812 T3 (5840 T3 + 3726 + 1128C)



**AS**

**333402AS**

300162

325,10 €

Termostático de ducha, con equipo de ducha.  
Thermostatic bath-shower mixer, with shower set.



333402 S + 5849 AS  
5849 AS (5811 AS + 3726 + 2471C)

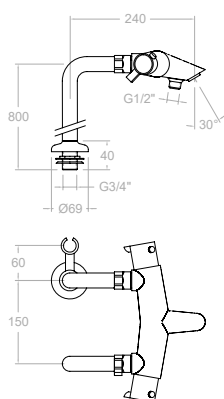

**3335S**  
221829

949,80 €

Termostático de baño - ducha sobre columnas sin equipo de ducha.

Thermostatic bath and shower mixer. Column mounted. Without shower set.

3339S-1370X2+3517

**3335M**  
257973

1.054,60 €

Termostático de baño- ducha sobre columnas con equipo de ducha.

Thermostatic bath and shower mixer column mounted. Complete set and shower set.

Cartucho Cartridge: 1700T + 4000

3339S-1370X2+3517+3713M+2471C



BRASS  
LATON

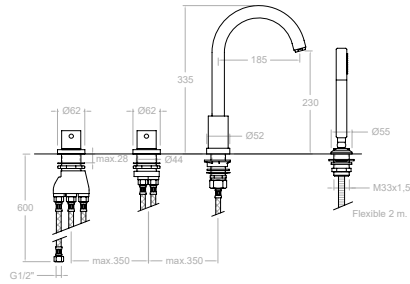

**333303TM**  
33C301654

904,80 €

Termostático de baño-ducha de repisa con equipo de ducha metálico.  
Thermostatic deck-mounted bath shower mixer with metallic shower set.



Cartucho Cartridge: 1700TE + 4000

T3333+D3333+C623302+9989SC+3713M+2850C

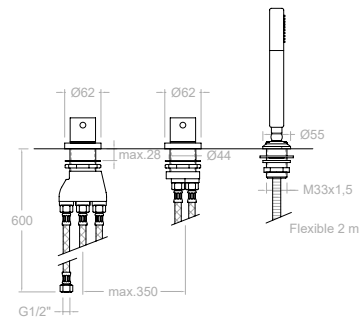

**3333TSCAM**  
255876

639,60 €

Termostático de baño-ducha de repisa con equipo de ducha metálico sin caño.  
Thermostatic deck-mounted shower mixer.



Cartucho Cartridge: 1700TE + 4000

T3333+D3333+9989SC+3713M+2850C

Recomendaciones Recommendations

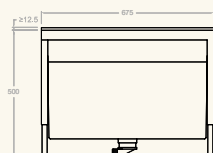

**100502**  
AAZ302174

699,00 €

Repisa extraíble con depósito para el agua de conjunto baño.  
Mounting block with heightadjustable panel and tube box for bath deck (included).

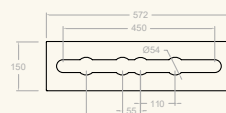

**100502R**  
AAZ302626

204,70 €

Repisa soporte para conjunto baño.  
Mounting plate for bath deck.





**335602RM300** 1.106,30 €  
33C303801

Columna de baño-ducha telescópica termostática rociador metálico Ø 300 mm.  
Thermostatic telescopic shower column, chrome metallic headshower Ø 300 mm

Cartucho Cartridge: 1701T + 4000  
334612S - RM300 + T18 + IDP16 + RM300 + 3713M + 2471C

**334612S** 379,10 €  
33C303809

Termostático baño - ducha con inversor integrado.  
Thermostatic Bath shower with integrated diverter.



**335602RM250** 1.049,70 €  
33C303800

Conjunto termostático gran baño - ducha con columna telescópica.  
Thermostatic bath and shower column. Adjustable height.

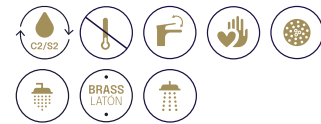

334612S + DN130D + T18 + IDP16 + RM250 + 3713M + 2471C

Cartucho Cartridge: 1701T + 4000

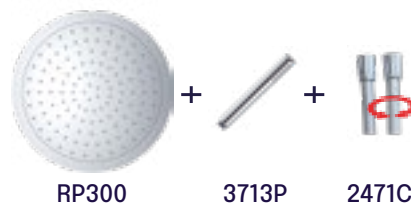

**335602RP300** 911,10 €  
33C303803

Conjunto termostático gran baño - ducha con columna telescópica.  
Thermostatic bath and shower column. Adjustable height.

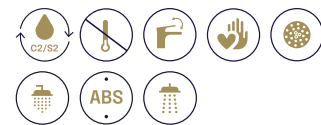

334612S + DN130D + T18 + IDP16 + RP300 + 3713P + 2471C

Cartucho Cartridge: 1701T + 4000

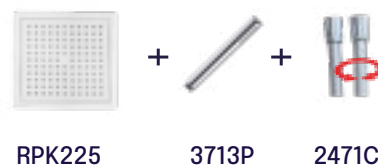

**335602RPK225** 911,10 €  
33C303804

Conjunto termostático gran baño - ducha con columna telescópica.  
Thermostatic bath and shower column. Adjustable height.

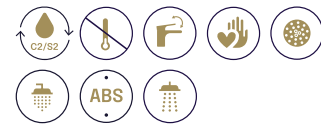

334612S + DN130D + T18 + IDP16 + RPK225 + 3713P + 2471C

Cartucho Cartridge: 1701T + 4000



**335403RPK225**

675,70 €

33D303724

Columna de ducha termostática telescópica, rociador cuadrado 225 mm.  
Thermostatic telescopic shower column, square abs headshower 225 mm.

331203S+DN130D+RPK225+3713P+2471C



**331203S**

256,60 €

33D303732

Termostático de ducha.  
Thermostatic shower chrome.

Cartucho Cartridge:1703T + 4000

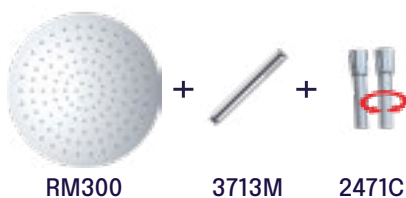

**335403RM300**

871,00 €

33D303722

Gran ducha termostática, columna telescópica.  
Thermostatic adjustable height shower column.



331203S+DN130D+RM300+3713M+2471C

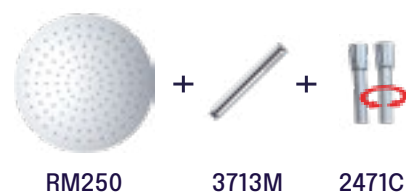

**335403RM250**

814,40 €

33D303720

Gran ducha termostática, columna telescópica.  
Thermostatic adjustable height shower column.



331203S+DN130D+RM250+3713M+2471C

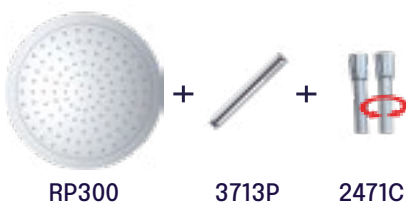

**335403RP300**

675,70 €

33D303723

Gran ducha termostática, columna telescópica.  
Thermostatic adjustable height shower column.



331203S+DN130D+RP300+3713P+2471C

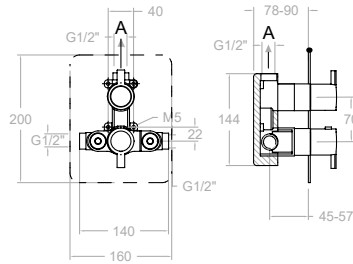

**332411S**  
33D302535

182,70 €

Termostático de ducha empotrado 1 vía con placa metálica.  
Thermostatic concealed mixer 1 way with ultraslim metallic plate.



XX2411S	1bar	3bar	5bar
A l/min	17	26	31

Kit de ampliación - Extension set: KAET103

1 Vía/Way

Cartucho Cartridge: 1703T + 1700C3/4"

XX2411+KTX1+335100+335000

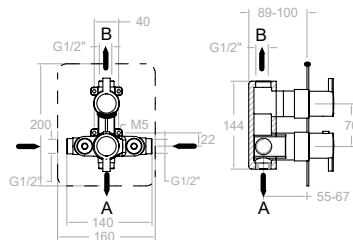

**338712S**  
33D302543

255,90 €

Termostático de ducha empotrado 2 vías con placa metálica.  
Thermostatic concealed mixer 2 ways with ultraslim metallic plate.



XX8712	1bar	3bar	5bar
A l/min	14	24	30
B l/min	13	22	28

Kit de ampliación - Extension set: KAET103

2 Vías/Ways

Cartucho Cartridge: 1703T + 4000

XX8712+KTX2+335100+335000

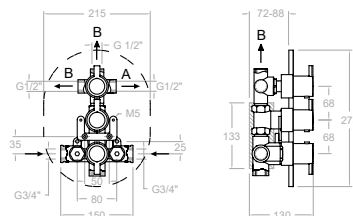

**3327S**  
229560

724,10 €

Termostático de ducha empotrado 3 vías con placa metálica.  
Thermostatic concealed mixer 3 ways with ultraslim metallic plate.



ETDI	CARTUCHO GRAN CAUDAL 1700 TE		
	1 Bar	2 Bar	3 Bar
A (Baño)	13,5	23,3	30,2
B (Baño)	9,3	15,5	19,2

Kit de ampliación - Extension set: KAETDI

3 Vías/Ways

Cartucho Cartridge: 1700TE + 1700C 3/4 + 1000I

ETDI+K23+3351+3352+3353

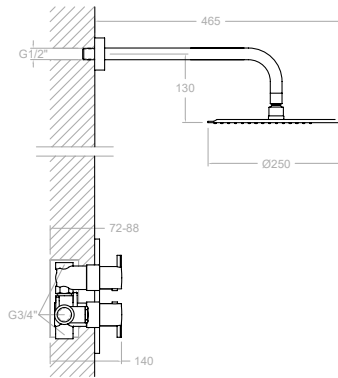

**K3324012**  
33D302749

414,50 €

Conjunto termostático empotrado 1 vía con rociador metálico ø 250 mm.  
Shower set with thermostatic 1 way mixer, water outlet, handshower, metallic headshower ø 250 mm.



Cartucho Cartridge: 1703TE + 1700C 3/4

332411S+BHRM250

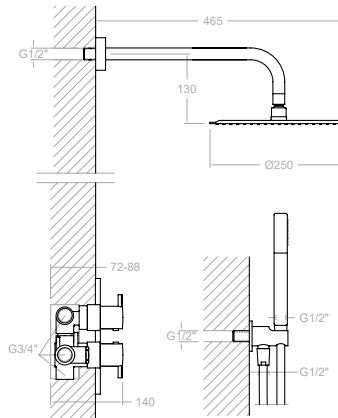

**K3387011**  
33D302754

597,90 €

Conjunto termostático empotrado 2 vías con soporte, toma de agua, teleducha y rociador metálico ø 250 mm.  
Shower set with thermostatic 2 ways mixer, water outlet, handshower, metallic headshower ø 250 mm.



Cartucho Cartridge: 1703T + 4000

338712S+BHRM250+3796+3713M+2471C

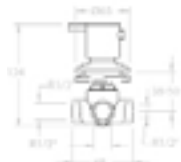

**3337**  
219489

168,60 €

Inversor de 3 vías.  
3 way concealed diverter.

Cartucho Cartridge: 1008S/V+3353

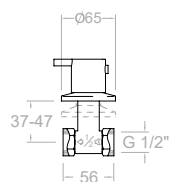

**33071/2X1**  
219471

78,00 €

Llave de paso de 1/2\"/>

Montura Head: 5000

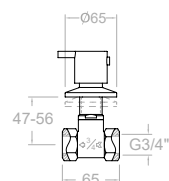

**33073/4X1**  
219480

96,10 €

Llave de paso de 3/4\"/>

Montura Head: 6000

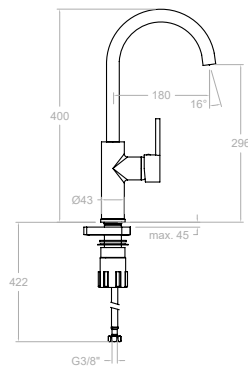

<b>330602</b> 33E301596	137,30 €	
<b>330602NM</b> 33E306168	209,80 €	
<b>330602CUC</b> 33E305120	249,60 €	

Monomando para fregadero con caño giratorio.  
Wash basin mixer with swivel spout.



Cartucho Cartridge: 35100 (6689-2)

# Gaudí

Colección Collection







### Características Técnicas

- Montura cerámica cerámica de ½" para bimandos.
- Cartucho cerámicos monomando de Ø 35 mm (Lavabo de caño giratorio y fregadero).
- Cartucho termostático con Sistema Hot Block de seguridad antiquemaduras y Sistema Termostop de bloqueo de la temperatura a 38°C.
- Caudal a 3 bar: Lavabo, Bidet y Fregadero (de 9 a 12 l/min). Ducha (de 12 a 16 l/min). Baño (≥20 l/min)
- Nivel acústico a 3 bar < 20 dB.
- Cromado latón: 15 micras de espesor de níquel, 0,3 micras de cromo.
- Presión de uso entre 1-5 bar, recomendada 3 bar. Resiste presiones estáticas ≤ 10 bar y golpes de ariete de 25 bar.
- Temperatura recomendada de agua caliente 55°C. Temperatura máxima de uso 65°C. Máximo 1h a 90°C.
- Resistente al choque térmico y químico anti-legionela.

### Technical Characteristics

- Ceramic ½" frame for twin handles.
- Ø35mm ceramic mixer tap cartridge (swivel pipe tap and sink).
- Thermostatic cartridge with Hot Block anti-burn system and Termostop temperature blocking system (to 38°C).
- Flow rate at 3 bars: Washbasin, bidet and sink (from 9 to 12 l min.); Shower (from 12 to 16 l/min.); and Bath (≥20 l/min.).
- Acoustic level at 3 bars: < 20 dB.
- Chrome-plated brass: 15 microns thick of nickel, 0.3 microns of chrome.
- Working pressure between 1-5 bars, recommended: 3 bars. It resists static pressures ≤ 10 bars and water hammers of 25 bars.
- Recommended temperature for the hot water: 55°C. Maximum working temperature: 65°C. Maximum: 1h at 90°C.
- Resistant to thermal and anti-Legionella chemical shocks.

Acabado disponible Finishing available



Cromo  
Chrome

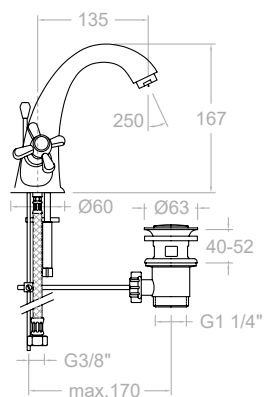

**3101C**

261827

253,80 €



Bimando de lavabo con caño giratorio.  
Twin lever washbasin mixer with swivel spout.

**3101CVA1167**

261828

278,00 €



Bimando de lavabo con caño giratorio y con válvula automática de latón 1/4\"/>

Twin lever washbasin mixer with swivel spout and automatic brass pop-up waste 1/4\"/>

Ref. 1167

Montura Head: 1700C1/2"

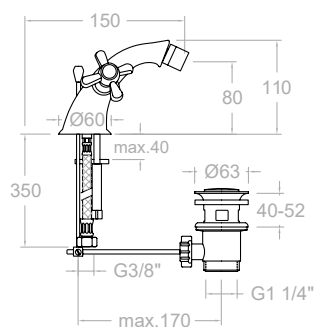
**3103C**

261829

253,80 €



Bimando de bidé.  
Twin lever bidet mixer.

**3103CVA1167**

261830

278,00 €



Bimando de bidé con válvula automática de latón 1/4\"/>

Twin lever bidet mixer with automatic brass pop-up waste 1/4\"/>

Ref. 1167

Montura Head: 1700C1/2"

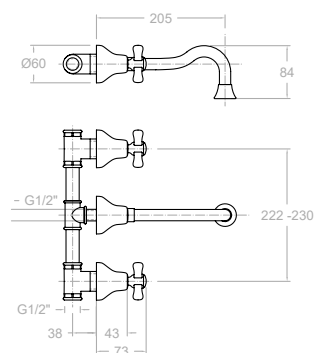
**3120C**

31A301590

402,80 €



Bimando de lavabo empotrado mural.  
Concealed washbasin twin handle chromed.

Montura Head: 1700C1/2"

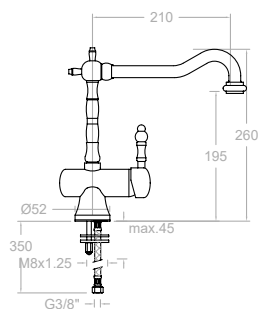

**3129**  
31E302780

437,00 €

Monomando de lavabo con caño de 21 cm giratorio.  
Washbasin mixer with swivel spout 21 cm.



Cartucho Cartridge: 35100-2

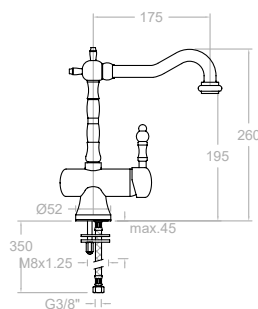

**3121**  
31A302779

405,40 €

Monomando de lavabo con caño de 17 cm giratorio.  
Washbasin mixer with swivel spout 17 cm.



Cartucho Cartridge: 35100-2

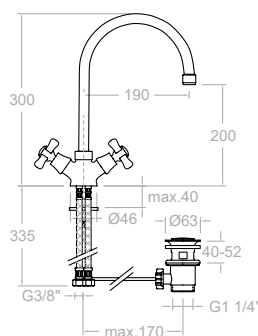

**3110C**  
300154

249,30 €

Bimando de lavabo con caño giratorio.  
Washbasin twin tap with swivel spout.



**3110CVA1167**  
300155

278,30 €

Bimando de lavabo con caño giratorio y con válvula automática de latón 1/4\"/>

Ref. 1167

Montura Head: 1700C1/2"

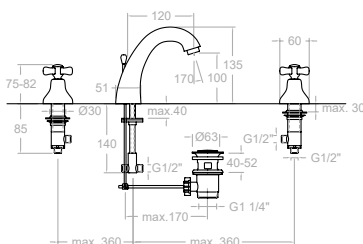

**3142C**  
261861

393,60 €

Bimando de lavabo para repisa.  
Washbasin twin lever deck mounted.



**3142CVA1167**  
261865

417,60 €

Bimando de lavabo para repisa con válvula automática de latón 1/4\"/>

Ref. 1167

Montura Head: 1700C1/2"

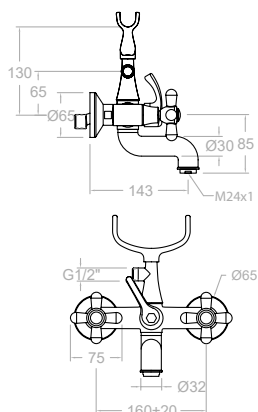

**3105CS**

261851

361,40 €



**Bimando de baño-ducha.**  
Twin lever bath-shower mixer.

Montura Head: 1700C1/2"

**3105CG**

261852

428,50 €



**Bimando de baño - ducha con equipo de ducha.**  
Twin lever bath and shower mixer - with shower kit.

3105CS + 3049G  
3049G (1224+1126+1128C)

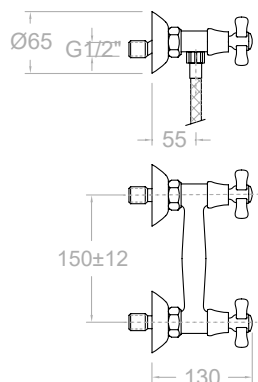
**3108CS**

261853

193,00 €



**Bimando de ducha.**  
Twin lever shower mixer.

Montura Head: 1700C1/2"

**3108CG**

261854

260,10 €



**Bimando de ducha con equipo de ducha.**  
Twin lever shower mixer with shower kit.

3108CS + 3049G  
3049G (1224+1126+1128C)

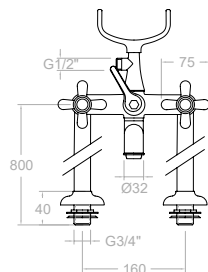
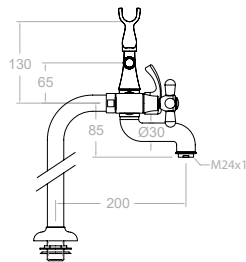

**3135CG**  
261862

1.009,70 €



Columna bimando para bañera con equipo de ducha.  
Column Twin lever bath and shower mixer with shower set.

Montura Head: 1700C1/2"  
3105CS + 1370SX2 + 1224 + 1128C

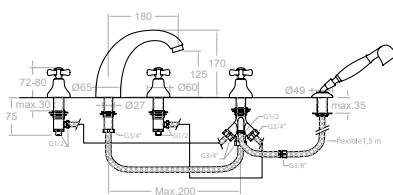

**3132CG**  
261860

886,50 €



Bimando de repisa de bañoducha de latón.  
Twin lever deck mounted bath shower tap with shower set.

Montura Head: 1700C1/2"  
3132CS + 1224 + 3189 SC + 2851C

Recomendaciones Recommendations

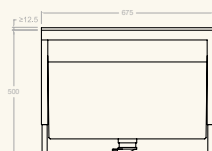

**100502**  
AAZ302174

699,00 €

Repisa extraíble con depósito para el agua de conjunto baño.  
Mounting block with heightadjustable panel and tube box for bath deck (included).

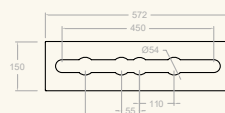

**100502R**  
AAZ302626

204,70 €

Repisa soporte para conjunto baño.  
Mounting plate for bath deck.

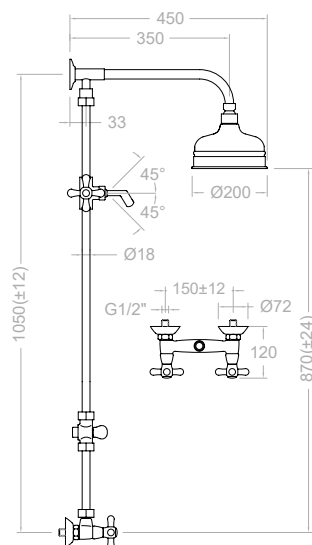

**3158CG**

261866

994,00 €

Columna de ducha latón bímando con rociador ø 200 mm.  
Shower column twin tap with ø 200 mm showerhead.



Montura Head: 1700C1/2"

3108CS+DT110+I3064+T20 -RG200+1224+1128C

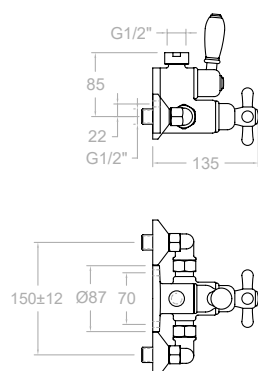
**3044**

194433

924,30 €

Termostático de ducha.  
Thermostatic shower mixer.

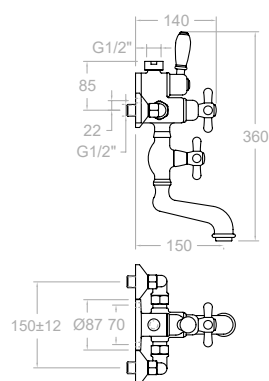

Cartucho Cartridge: 1700TE + 1700C 1/2"

**3048**

220461

1.503,60 €

Termostático de baño-ducha.  
Thermostatic bath-shower mixer.



Cartucho Cartridge: 1700TE + 1700C 1/2"

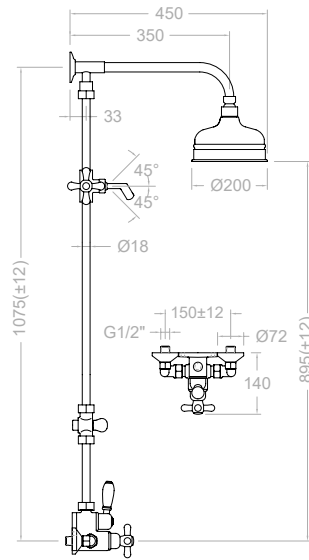

**3064G**  
194325

1.693,40 €

Columna termostática de ducha latón con rociador ø 200 mm.  
Thermostatic shower column with ø 200 mm showerhead.



Cartucho Cartridge: 1700TE+1700C1/2"

3044+DT110+T20+I3064+RG200+1224+1128C

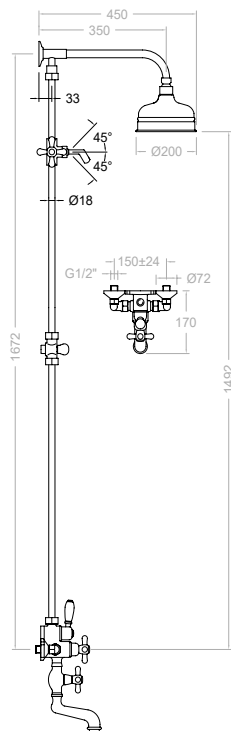

**3068G**  
218499

2.273,00 €

Columna termostática de baño- ducha inox con rociador  
ø 200 mm.  
Thermostatic bath-shower column with ø 200 mm showerhead.



Cartucho Cartridge: 1700TE + 1700C 1/2"

3048+DT110+T75+I3064+RG200+1224+1128C

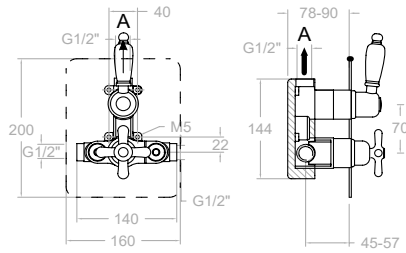

**302411S**  
30D302534

181,90 €

Termostático de ducha empotrado 1 vía con placa metálica.  
Concealed thermostatic mixer 1 way with metallic cover plate.



1 Vía/Way

XX2411S	1bar	3bar	5bar
A l/min	17	26	31

Kit de ampliación - Extension set: KAETI04

Cartucho Cartridge: 1703T + 1700C3/4"

XX2411+KTX1+305100+305000

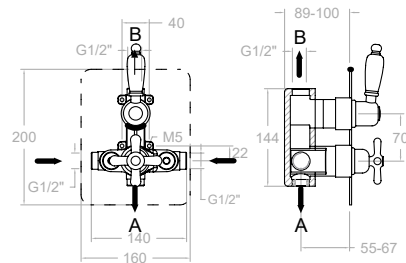

**308712S**  
30D302542

266,50 €

Termostático de baño-ducha empotrado metálico 2 vías con placa extraplana.  
Concealed thermostatic mixer 2 ways with ultraslim metallic cover plate.



2 Vías/Ways

XX8712S	1bar	3bar	5bar
A l/min	14	24	30
B l/min	13	22	28

Kit de ampliación - Extension set: KAETI03

Cartucho Cartridge: 1703T + 4000

XX8712+KTX2+305100+305000

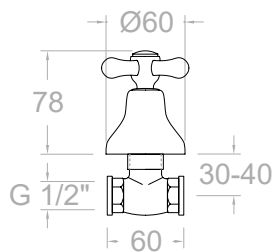

**3107C1/2X1**

300153

118,70 €



Llave de paso de 1/2".  
1/2" Angle valve.

Montura Head: 1700C1/2"

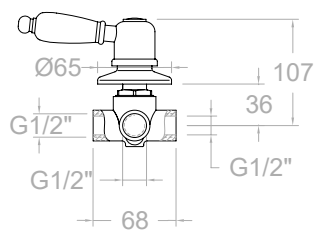

**3037**

209832

259,70 €



Inversor de 3 vías.  
3 ways diverter.

Cartucho Cartridge: 10001

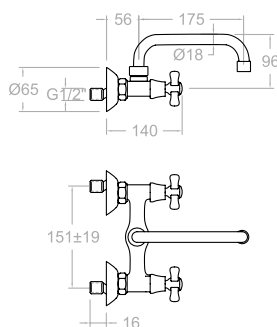

**3117C**

300156

205,80 €



Bimando de fregadero mural con caño giratorio.  
Wall sink twin tap with swivel spout.

Montura Head: 1700C1/2"

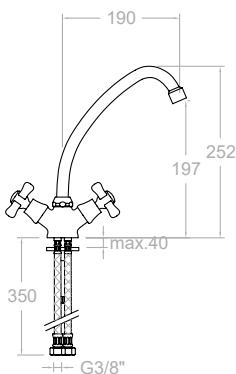

**3109C**

261867

205,30 €



Bimando de fregadero con caño giratorio altura (L).  
Sink twin tap with swivel spout.

Montura Head: 1700C1/2"

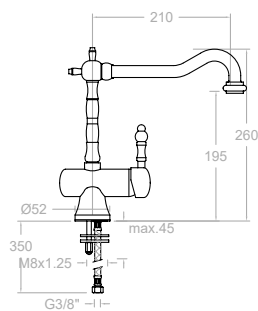

**3129**  
31E302780

437,00 €

Monomando de lavabo con caño de 21 cm giratorio.  
Washbasin mixer with swivel spout 21 cm.



Cartucho Cartridge: 35100-2

# New Fly

Colección Collection





## Características Técnicas

- Cartuchos cerámicos monomando.
- Ø35mm en Ducha, Baño-ducha, Fregadero mural, Fregadero vertical, Ducha empotrado y Baño-ducha empotrado.
- Ø40mm en Lavabos, Bidé, Fregaderos extraíble.
- Cartuchos cerámicos monomando con Sistema Termostop Block de limitación de la temperatura máxima del agua caliente y con Sistema de ahorro de agua (S2-C2) mediante la apertura de la manecilla en dos fases. Disponible en algunos modelos el Sistema de apertura central en frío (S3-C3).
- Caudal a 3 bar: Lavabo, Bidet y Fregadero (de 9 a 12 l/min). Ducha (de 12 a 16 l/min). Baño ( $\geq 20$  l/min).
- Prestaciones de confort a nivel de fidelidad, sensibilidad y constancia en la selección de la temperatura.
- Nivel acústico a 3 bar < 20 dB.
- Cromado latón: 15 micras de espesor de níquel, 0,3 micras de cromo.
- Presión de uso entre 1-5 bar, recomendada 3 bar. Resiste presiones estáticas  $\leq 10$  bar y golpes de ariete de 25 bar.
- Temperatura recomendada de agua caliente 55°C. Temperatura máxima de uso 65°C. Máximo 1h a 90°C.
- Resistente al choque térmico y químico anti-legionela.
- Certificado sanitario ACS.
- Ánodo de sacrificio anticorrosión de zinc-magnesio.

## Technical Characteristics

- Ceramic mixer tap cartridge.
- Ø35mm for showers, bath-showers, vertical sinks, embedded showers and embedded bath-showers.
- Ø40mm for washbasins, bidets, removable sinks.
- Ceramic mixer tap cartridge with Termostop Block System limiting the maximum temperature of hot water and a water saving system (S2-C2) by a two-phase opening lever. The cold central opening system (S3-C3) is available in some models.
- Flow rate at 3 bar: Washbasin, bidet and sink (from 9 to 12 l/min.); Shower (from 12 to 16 l/min.); and Bath ( $\geq 20$  l/min.).
- Comfortable performance as regards to reliability, sensitivity and reliability in the temperature selection.
- Acoustic level at 3 bar: < 20 dB
- Chrome-plated brass: 15 microns thickness of nickel, 0.3 microns of chrome.
- Working pressure between 1-5 bar, recommended pressure: 3 bar. It resists static pressures  $\leq 10$  bar and pressure oscillations of 25 bar.
- Recommended temperature for the hot water: 55°C. Maximum working temperature: 65°C. Maximum: 1h at 90°C.
- Resistant to thermal and anti-Legionella chemical shocks.
- ACS health compliance certificate.
- Zinc-Magnesium Anti-Corrosion Sacrificial Anode.

## Acabados disponibles Finishing availables



 Cromo  
Chrome



 Negro mate  
Black matte



Montaje sin herramientas  
Tool-free system



TOOL FREE

570211 hasta fin de existencias  
570211 until end of stock

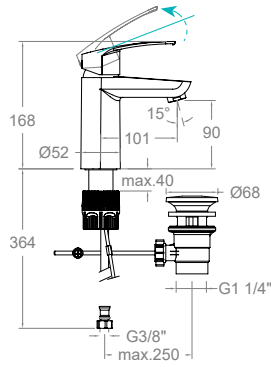

570211

57A305651

67,10 €

Monomando de lavabo  
Washbasin mixer

570211VA9065

57A306066

77,80 €

Monomando de lavabo, con válvula automática 1/4\"/>

Ref. 9065 ABS

570211V1169

57A306065

86,40 €

Monomando de lavabo, con válvula automática 1/4\"/>

Ref. 1169 INOX

Cartucho Cartridge: 40100-3



Ahorro de energía  
Apertura en frío

Energy saving  
Cold opening



Cartucho Cartridge: 40301-3

570213

57A305994

67,10 €

Monomando de lavabo con apertura en frío.  
Washbasin mixer, cold opening.

570213VA9065

57A306068

77,80 €

Monomando de lavabo, apertura en frío con válvula automática 1/4\"/>

Ref. 9065 ABS

570213V1169

57A306067

86,40 €

Monomando de lavabo, apertura en frío con válvula automática 1/4\"/>

Ref. 1169 INOX



TOOL FREE

Disponible en Julio  
Available in July

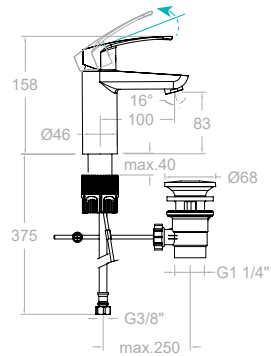

570221

57A307809

65,10 €

Monomando de lavabo.  
Washbasin mixer.

570221VA9065

57A307812

75,50 €

Monomando de lavabo, con válvula automática 1/4\"/>

Ref. 9065 ABS

570221VA1169

57A307811

83,90 €

Monomando de lavabo, con válvula automática 1/4\"/>

Ref. 1169 INOX

Cartucho Cartridge: 35100-3



Ahorro de energía  
Apertura en frío

Energy saving  
Cold opening



Cartucho Cartridge: 35300-3

570223

57A307810

65,10 €

Monomando de lavabo con apertura en frío.  
Washbasin mixer, cold opening.

570223VA9065

57A307814

75,50 €

Monomando de lavabo, apertura en frío con válvula automática 1/4\"/>

Ref. 9065 ABS

570223VA1169

57A307813

83,90 €

Monomando de lavabo, apertura en frío con válvula automática 1/4\"/>

Ref. 1169 INOX



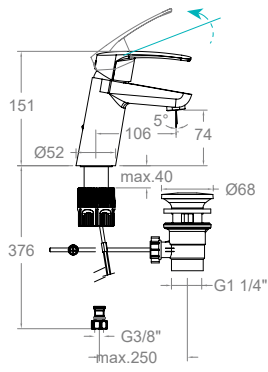

**570111** 68,30 €  
57A305652

Monomando de lavabo.  
Washbasin mixer.

**570111VA9065** 79,00 €  
57A306062

Monomando de lavabo, con válvula automática 1/4".  
Washbasin mixer with pop-up waste 1/4".

Ref. 9065 ABS

Cartucho Cartridge: 40100-3

**570111NM** 105,00 €  
57A305996

Monomando de lavabo.  
Washbasin mixer.

**570111V1169** 87,60 €  
57A306058

Monomando de lavabo, con válvula automática 1/4".  
Washbasin mixer with stainless steel pop-up waste 1/4".

Ref. 1169 INOX



**Ahorro de energía**  
**Apertura en frío**

Energy saving  
Cold opening



Cartucho Cartridge: 40301-3

**570113** 68,30 €  
57A305995

Monomando de lavabo con apertura en frío.  
Washbasin mixer, cold opening.

**570113VA9065** 79,00 €  
57A306068

Monomando de lavabo, apertura en frío con válvula automática 1/4".  
Washbasin mixer cold opening with pop-up waste 1/4".

Ref. 9065 ABS

**570113V1169** 87,60 €  
57A306067

Monomando de lavabo, apertura en frío con válvula automática 1/4".  
Washbasin mixer cold opening with stainless steel pop-up waste 1/4".

Ref. 1169 INOX

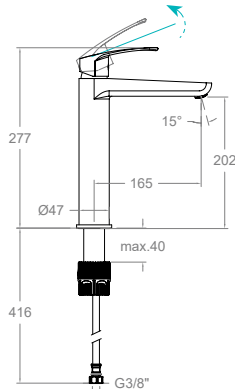

**571011** 145,30 €  
57A306082

**571011NM** 217,90 €  
57A306083

Monomando de lavabo (L).  
Washbasin mixer (L).

Cartucho Cartridge: 35100 (6689-2)

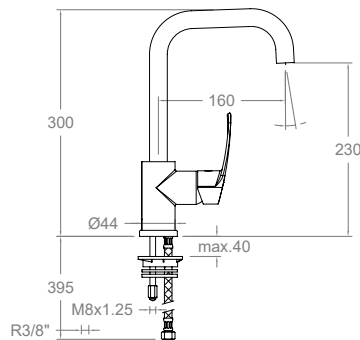

**571101** 100,50 €  
57A303579

Monomando de lavabo, con caño giratorio.  
Washbasin with high swivel spout.

Cartucho Cartridge: 35200 (6689C2)





TOOL FREE

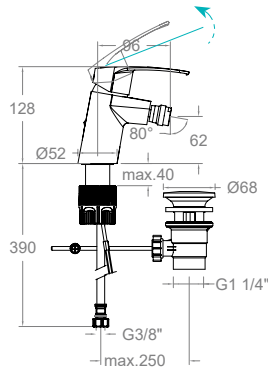

**570311** 67,10 €  
57B305653 ●

Monomando de bidé.  
Bidet mixer.

**570311VA9065** 77,80 €  
57B306077 ●

Monomando de lavabo, con válvula automática 1 1/4".  
Washbasin mixer with pop-up waste 1 1/4".

Ref. 9065 ABS

Cartucho Cartridge: 40100-3

**570311NM** 103,00 €  
57B305997 ●

Monomando de bidé.  
Bidet mixer.

**570311V1169** 86,40 €  
57B306075 ●

Monomando de lavabo, con válvula automática 1 1/4".  
Washbasin mixer with stainless steel pop-up waste 1 1/4".

Ref. 1169 INOX

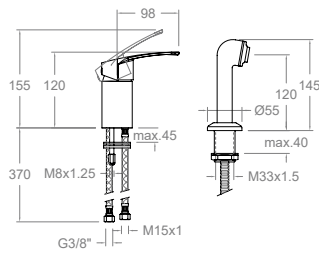

**572201** 180,70 €  
57D303554 ●

Monomando para peluquería con equipo de ducha.  
Single lever mixer for hairdresser with shower set.

Cartucho Cartridge: 40101

**572201S** 90,90 €  
57D303555 ●

Monomando para peluquería.  
Single lever mixer for hairdresser.

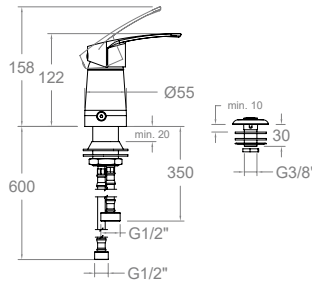

**SA572301** 94,90 €  
57B303554 ●

Monomando para bidé de repisa con ducha.  
Deck mounted bidet.

Cartucho Cartridge: 40100 (3388)

**SA572301NM** 138,40 €  
57B306752 ●



Venta en el Continente Americano  
Available in North, Central & South America

Recomendaciones Recommendations



**1219L** 27,40 €  
197106 ●

**1219LNM** 41,10 €  
99Z302477 ●

Sistema CLICK CLAK lavabo en Latón.  
CLICK CLACK wash Laton system.



**121602P** 16,50 €  
AAZ303592 ●

Sistema CLICK CLAK lavabo en PVC-Inox.  
CLICK CLACK wash PVC-Inox system.

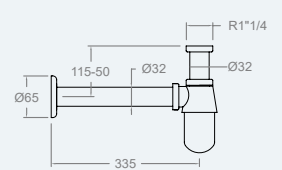
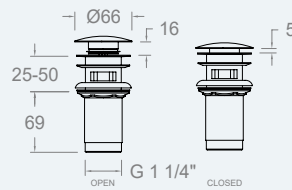

**1290** 35,90 €  
204405 ●

Sifón Latón.  
Brass Siphon.



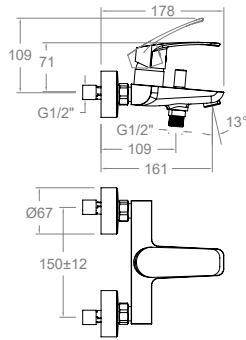

**570502S** 95,50 €  
57C303572 ●

**570502SNM** 172,00 €  
57C303580 ●

Monomando de baño-ducha sin equipo de ducha.  
Bath and shower mixer without shower kit.

**570502T1** 139,40 €  
57C303574 ●

Monomando de Baño-Ducha con equipo de ducha.  
Bath and shower mixer with shower set.

570502S + 3520T1+3726+1128C

**570502T3** 145,40 €  
57C303573 ●

570502S + 5812T3 / 5812T3(5840T3+3726+1128C)

**570502BTNM** 297,10 €  
57C303581 ●

Monomando de Baño-Ducha con equipo de ducha.  
Bath and shower mixer with shower set.

570502SNM + 2876BTNM + 372602NM + 2475CNM

Cartucho Cartridge: 35200-2

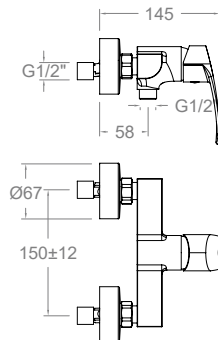

**570802S** 75,90 €  
57D303575 ●

**570802SNM** 137,90 €  
57D303699 ●

Monomando de baño-ducha sin equipo de ducha.  
Bath and shower mixer without shower kit.

**570802T1** 119,80 €  
57D303577 ●

Monomando de baño-ducha con equipo de ducha.  
Bath and shower mixer with shower set.

570802S + 3520T1 + 3726 + 1128C

**570802T3** 126,00 €  
57D303576 ●

570802S + 5812T3 / 5812T3 (5840T3+3726+1128C)

**570802BTNM** 263,20 €  
57D303583 ●

Monomando de Baño-Ducha con equipo de ducha.  
Bath and shower mixer with shower set.

570802SNM + 2876BTNM + 372602NM + 2475CNM

Cartucho Cartridge: 35200-2





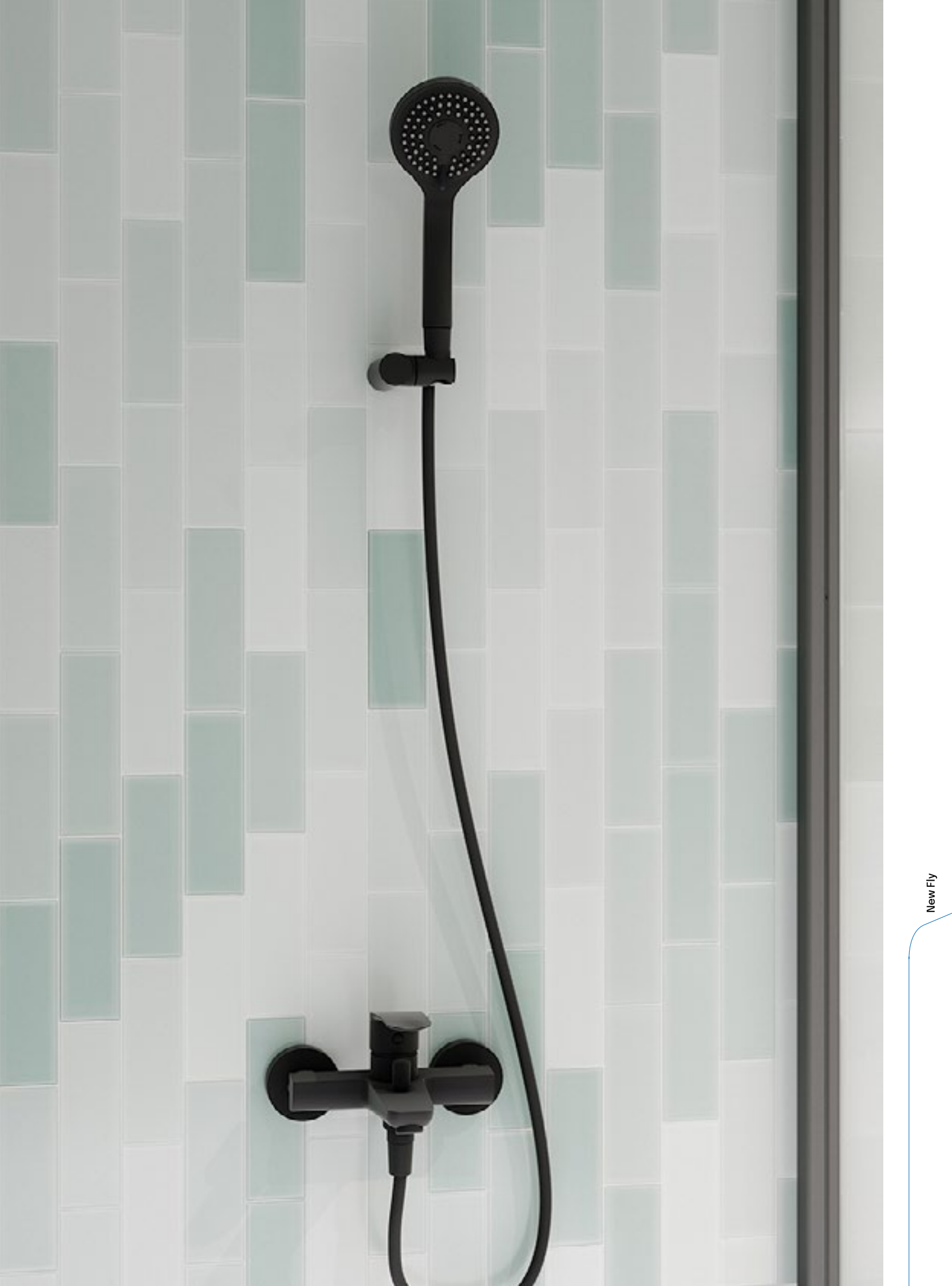

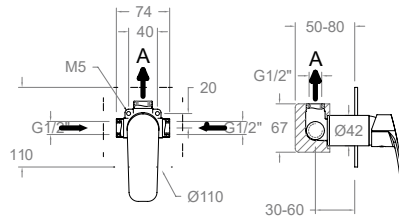

**571801S** 87,90 €  
 57D303551  
 XX1801+5700-35+KX1

**571801SNM** 157,60 €  
 57D303569  
 XX1801NM+5700N-35NM+KX1NM

Monomando de ducha empotrado 1 vía con placa metálica.  
 Single lever concealed mixer 1 way with ultraslim metallic plate.

XX1801	1bar	3bar	5bar
A l/min	17	26	34

Kit de ampliación - Extension set: KA1V



1 Vía/Way

Cartucho Cartridge: 35100 (6689-2)

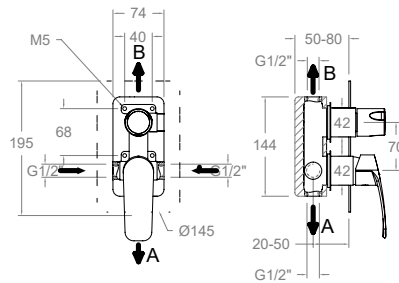

**571502S** 160,00 €  
 57C303552  
 XX1502 + 5700N-35 + 945100 + KX2

**571502NM** 286,90 €  
 57C303570  
 XX1502NM+5700N-35NM+945100NM+KX2NM

Monomando de ducha empotrado 2 vías con placa metálica.  
 Single lever concealed mixer 2 ways with ultraslim metallic plate.

XX1502	1bar	3bar	5bar
A l/min	14	24	30
B l/min	13	22	29

Kit de ampliación - Extension set: KA2V



2 Vías/Ways

Cartucho Cartridge: 35100 (6689-2)+4004

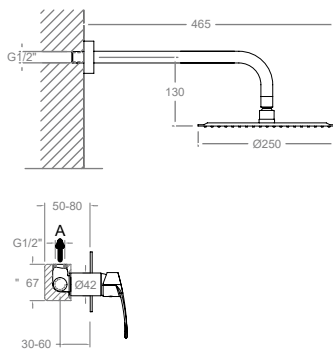
**K5718012**

191,70 €

57D304228

571801S + BHRP240 (Ø240)

**K5718012NM**

330,60 €

57D304229

571801SNM + BHRP240NM

**Conjunto monomando empotrado 1 vía con rociador ø 240 mm.**

Shower set with concealed single lever 1 way mixer, headshower ø 240 mm.

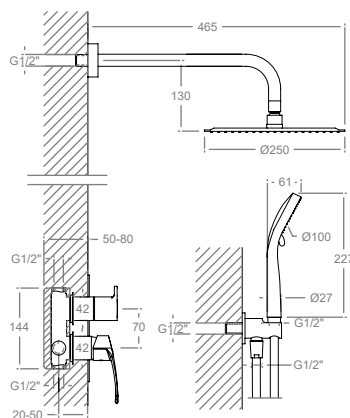

Cartucho Cartridge: 35100 (6689-2)

**K5715021**

357,70 €

57C304225

571502S+ BHRP240 +2876BT+2471C+3796

**K5715021NM**

617,50 €

57D304226

571502SNM+ bhRP240NM+2876BTNM+ 2475CNM +3796NM

**Conjunto monomando empotrado 2 vías con soporte, toma de agua, teleducha y rociador mural ø 240 mm.**

Shower set with concealed single lever 2 ways mixer, water outlet, handshower, headshower ø 240 mm.



Cartucho Cartridge: 35100 (6689-2)+4004

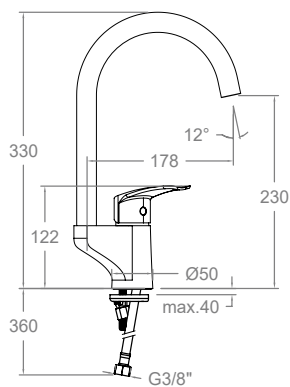

**572601**  
57E303550

94,10 €

Monomando de fregadero con caño alto giratorio 360°.  
Skin mixer with swivel high spout.



Cartucho Cartridge: 35100-3

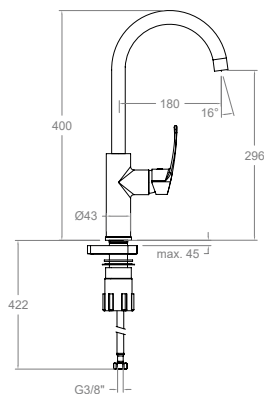

**570611**  
57E303548

103,70 €

**570611NM**  
57E306167

155,60 €

Monomando de fregadero con caño alto giratorio.  
Skin mixer with swivel high spout.



Cartucho Cartridge: 35100 (6689-2)

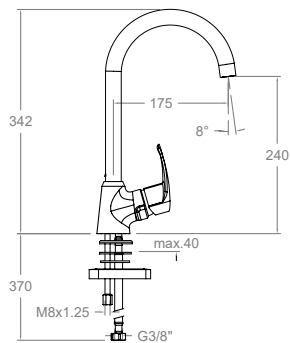

**570601**  
57E303496

85,60 €

Monomando de fregadero con caño alto giratorio.  
Skin mixer with swivel high spout.



Cartucho Cartridge: 35100 (6689-2)

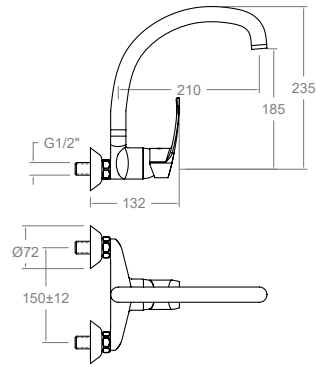

**571701C**  
57E303557

97,70 €

Monomando de fregadero mural con caño giratorio.  
Skin mixer with above swivel pout.



Cartucho Cartridge: 35100

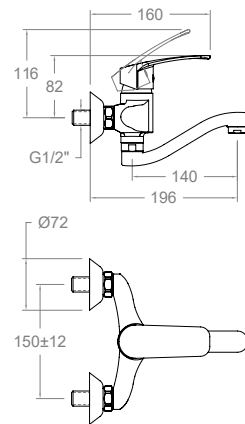

**570701CCB14**  
57E303558

106,30 €

Monomando de fregadero mural con caño bajo conformado corto de 14 cm.  
Wall sink mixer with with swivel short spout 14 cm.



Cartucho Cartridge: 35100-3

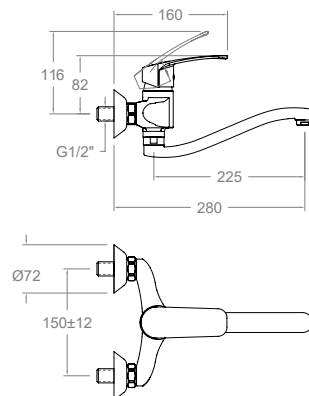

**570701CC**  
57E303559

111,90 €

Monomando de fregadero mural con caño bajo conformado corto de 22,5cm.  
Wall sink mixer with with swivel short spout 22,5 cm.



Cartucho Cartridge: 35100-3

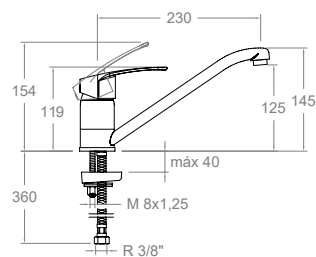

**570901C**  
57E303549

85,10 €

Monomando de fregadero con caño bajo giratorio.  
Sink mixer with long swivel spout.



Cartucho Cartridge: 40200-2

Repuestos:  
[www.ramonsoler.net/productos/catalogos](http://www.ramonsoler.net/productos/catalogos)  
Spare parts:  
[www.ramonsoler.net/products/catalogs](http://www.ramonsoler.net/products/catalogs)

# Ypsilon Plus

Colección Collection





## Características Técnicas

- Cartuchos cerámicos monomando: Ø35mm en Ducha, Baño-ducha, Fregadero mural, Fregadero vertical, Ducha empotrado y Baño-ducha empotrado. Ø40mm en Lavabos, Bidé, Fregaderos extraíble.
- Cartuchos cerámicos monomando con Sistema Termostop Block de limitación de la temperatura máxima del agua caliente y con Sistema de ahorro de agua (S2-C2) mediante la apertura de la manecilla en dos fases. Disponible en algunos modelos el Sistema de apertura central en frío (S3-C3).
- Caudal a 3 bar: Lavabo, Bidet y Fregadero (de 9 a 12 l/min). Ducha (de 12 a 16 l/min). Baño ( $\geq 20$  l/min).
- Prestaciones de confort a nivel de fidelidad, sensibilidad y constancia en la selección de la temperatura.
- Nivel acústico a 3 bar < 20 dB.
- Cromado latón: 15 micras de espesor de níquel, 0,3 micras de cromo.
- Presión de uso entre 1-5 bar, recomendada 3 bar. Resiste presiones estáticas  $\leq 10$  bar y golpes de ariete de 25 bar.
- Temperatura recomendada de agua caliente 55°C. Temperatura máxima de uso 65°C. Máximo 1h a 90°C.
- Resistente al choque térmico y químico anti-legionela.
- Certificado sanitario ACS.
- Ánodo de sacrificio anticorrosión de zinc-magnesio.

## Technical Characteristics

- Ceramic mixer tap cartridge.
- Ø35mm for showers, bath-showers, vertical sinks, embedded showers and embedded bath-showers.
- Ø40mm for washbasins, bidets, removable sinks.
- Ceramic mixer tap cartridge with Termostop Block System limiting the maximum temperature of hot water and a water saving system (S2-C2) by a two-phase opening lever. The cold central opening system (S3-C3) is available in some models.
- Flow rate at 3 bar: Washbasin, bidet and sink (from 9 to 12 l/min.); Shower (from 12 to 16 l/min.); and Bath ( $\geq 20$  l/min.).
- Comfortable performance as regards to reliability, sensitivity and reliability in the temperature selection.
- Acoustic level at 3 bar: < 20 dB
- Chrome-plated brass: 15 microns thickness of nickel, 0.3 microns of chrome.
- Working pressure between 1-5 bar, recommended pressure: 3 bar. It resists static pressures  $\leq 10$  bar and pressure oscillations of 25 bar.
- Recommended temperature for the hot water: 55°C. Maximum working temperature: 65°C. Maximum: 1h at 90°C.
- Resistant to thermal and anti-Legionella chemical shocks.
- ACS health compliance certificate.
- Zinc-Magnesium Anti-Corrosion Sacrificial Anode.

Acabado disponible Finishing available



 **Cromo**  
Chrome



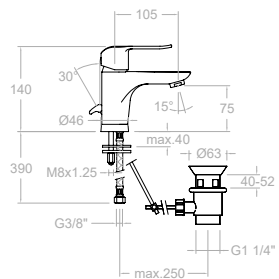

- |   |                        |                      |
|---|------------------------|----------------------|
| <p><b>6401</b><br/>261580</p> <p>Monomando de lavabo.<br/>Washbasin mixer.</p>  | <p><b>82,20 €</b></p>  | <br><br><br><br><br> |
| <p><b>6401VA9065</b><br/>261626</p> <p>Monomando de lavabo, con válvula automática 1 1/4".<br/>Washbasin mixer with pop-up waste 1 1/4".</p> <p>Ref. 9065 ABS</p>                     | <p><b>93,10 €</b></p>  |                      |
| <p><b>6401VA1169</b><br/>64A301991</p> <p>Monomando de lavabo, con válvula automática 1 1/4".<br/>Washbasin mixer with stainless steel pop-up waste 1 1/4".</p> <p>Ref. 1169 INOX</p> | <p><b>101,40 €</b></p> |                      |

Cartucho Cartridge: 35100 (6689-2)

**Ahorro de energía**  
**Apertura en frío**

Energy saving  
Cold opening



- |   |                        |                      |
|---|------------------------|----------------------|
| <p><b>6491</b><br/>259602</p> <p>Monomando de lavabo con apertura en frío.<br/>Washbasin mixer, cold opening.</p>   | <p><b>87,30 €</b></p>  | <br><br><br><br><br> |
| <p><b>6491VA9065</b><br/>259620</p> <p>Monomando de lavabo, apertura en frío con válvula automática 1 1/4".<br/>Washbasin mixer cold opening with pop-up waste 1 1/4".</p> <p>Ref. 9065 ABS</p>                     | <p><b>98,30 €</b></p>  |                      |
| <p><b>6491VA1169</b><br/>64A302803</p> <p>Monomando de lavabo, apertura en frío con válvula automática 1 1/4".<br/>Washbasin mixer cold opening with stainless steel pop-up waste 1 1/4".</p> <p>Ref. 1169 INOX</p> | <p><b>106,60 €</b></p> |                      |

Cartucho Cartridge: 35300 (6689C3)



- |   |                        |                      |
|---|------------------------|----------------------|
| <p><b>6410</b><br/>257604</p> <p>Monomando de lavabo (XL).<br/>High washbasin mixer (XL).</p> | <p><b>151,30 €</b></p> | <br><br><br><br><br> |
|---|------------------------|----------------------|

Cartucho Cartridge: 35100 (6689-2)

Recomendaciones Recommendations



- |   |                       |
|---|-----------------------|
| <p><b>1219L</b><br/>197106</p> <p>Sistema CLICK CLACK lavabo en LATON.<br/>CLICK CLACK wash BRASS system.</p> | <p><b>27,40 €</b></p> |
|---|-----------------------|

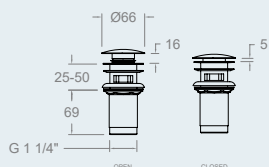

- |   |                       |
|---|-----------------------|
| <p><b>1290</b><br/>204405</p> <p>Sifón latón.<br/>Brass siphon.</p> | <p><b>35,90 €</b></p> |
|---|-----------------------|

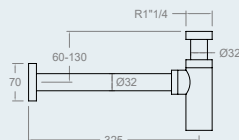

- |  |                       |
|--|-----------------------|
| <p><b>121602P</b><br/>AAZ303592</p> <p>Sistema CLICK CLACK lavabo en PVC-INOX.<br/>CLICK CLACK wash PVC-INOX system.</p> | <p><b>16,50 €</b></p> |
|--|-----------------------|

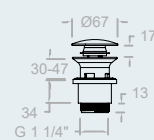

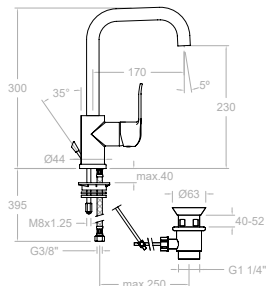

**6411** 102,80 €  
300088

Monomando de lavabo, con caño giratorio.  
Washbasin with high swivel spout.

**6411VA9065** 113,60 €  
300089

Monomando de lavabo, con válvula automática 1 1/4.  
Washbasin mixer with pop-up waste 1 1/4.

Ref. 9065 ABS

**6411VA1167** 126,10 €  
300090

Monomando de lavabo, con válvula automática 1 1/4.  
Washbasin mixer with stainless steel pop-up waste 1 1/4.

Ref. 1167

Cartucho Cartridge: 35200

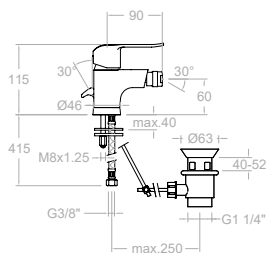

**6403** 83,70 €  
257514

Monomando de bidé.  
Bidet mixer.

**6403VA9065** 94,60 €  
257523

Monomando de bidé, con válvula automática 1 1/4.  
Washbasin mixer with pop-up waste 1 1/4.

Ref. 9065 ABS

**6403VA1169** 102,90 €  
64B302802

Monomando de bidé, con válvula automática 1 1/4.  
Washbasin mixer with stainless steel pop-up waste 1 1/4.

Ref. 1169 INOX

Cartucho Cartridge: 35200 (35100)



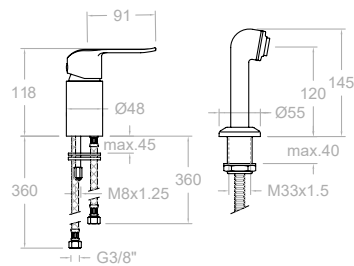

**642201**  
64D301619

185,90 €

Monomando de peluquerías con equipo de ducha.  
Deck mounted bidet mixer with shower.



Cartucho Cartridge: 40101

642201S-9553+9989SC+2950C

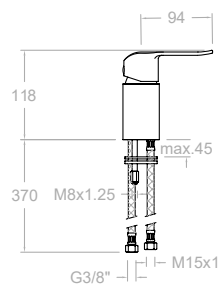

**642201S**  
64D301618

96,70 €

Monomando de peluquerías sin equipo de ducha.  
Deck mounted bidet mixer without shower.



Cartucho Cartridge: 40101

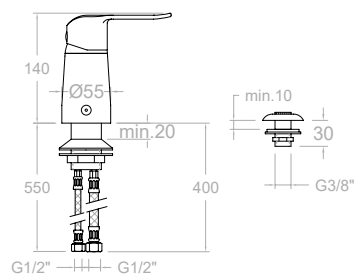

**SA6423**  
300270

96,30 €

Monomando para bidé de repisa con ducha.  
Deck mounted bidet.



Cartucho Cartridge: 40100 (3388)

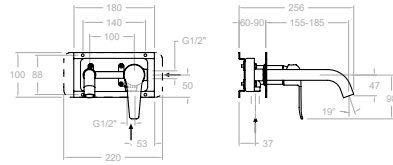

**642002**  
64A300697

217,70 €

Monomando de lavabo empotrado, caño 19 cm.  
Concealed wash Basin mixer 19 cm spout.

XX20CT+6400N-35+CLET+RB20

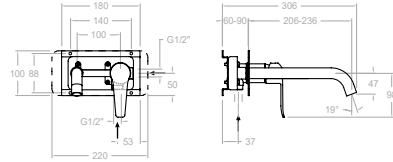

**642003**  
64A301465

227,80 €

Monomando de lavabo empotrado, caño 24 cm.  
Concealed wash Basin mixer 24 cm spout.

XX20CT+6400N-35+CLET24+RB20

Cartucho Cartridge: 35100-2

Kit de ampliación Extension set: KAB

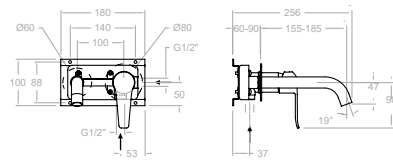

**642102**  
64A300696

217,70 €

Monomando de lavabo empotrado, caño 19 cm.  
Concealed wash Basin mixer 19 cm spout.

XX20CT+6400N-35+CLET+RB2IS+RB21H

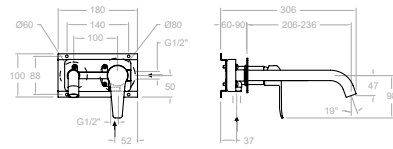

**642103**  
64A301466

227,80 €

Monomando de lavabo empotrado, caño 24 cm.  
Concealed wash Basin mixer 24 cm spout.

XX20CT+6400N-35+CLET24+RB2IS+RB21H

Cartucho Cartridge: 35100-2

Kit de ampliación Extension set: KAB

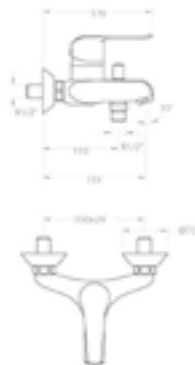

**6405S**

257541

105,90 €

Monomando de baño - ducha sin equipo de ducha.  
Bath and Shower mixer without shower kit.

**T1****6405T1**

257559

149,80 €

Monomando de baño - ducha sin equipo de ducha.  
Bath and Shower mixer without shower kit.

6405 S + 3553 T1  
3553 T1 (3520 T1 + 3726 + 1128C)

**T3****6405T3**

261753

155,80 €

Monomando de baño - ducha sin equipo de ducha.  
Bath and Shower mixer without shower kit.

6405 S + 5812 T3  
5812 T3 (5840 T3 + 3726 + 1128C)



Cartucho Cartridge: 35200 (6689)

**6408S**

257577

91,60 €

Monomando de ducha sin equipo de ducha.  
Bath and shower mixer without shower set.

**T1****6408T1**

257595

135,40 €

Monomando ducha con equipo de ducha.  
Bath and shower mixer with shower set.

6408 S + 3553 T1  
3553 T1 (3520 T1 + 3726 + 1128C)

**T3****6408T3**

261755

141,60 €

Monomando ducha con equipo de ducha.  
Bath and shower mixer with shower set.

6408 S + 5812 T3  
5812 T3 (5840 T3 + 3726 + 1128C)



Cartucho Cartridge: 35200 (6689)

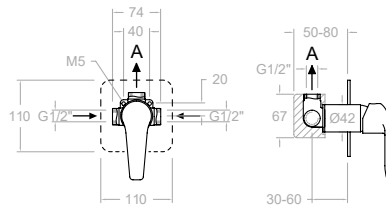

**641801S**  
64D300676

95,70 €

Monomando de ducha empotrado 1 vía con placa metálica.  
Single lever concealed mixer 1 way with ultraslim metallic plate.

XX1801	1bar	3bar	5bar
A l/min	17	26	34

Kit de ampliación - Extension set: KA1V



1 Vía/Way

Cartucho Cartridge: 35100 (6689-2)

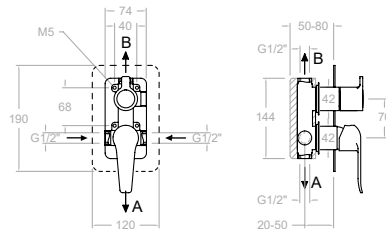

**641502S**  
64C300677

174,20 €

Monomando de ducha empotrado 2 vías con placa metálica.  
Single lever concealed mixer 2 way with ultraslim metallic plate.

XX1502	1bar	3bar	5bar
A l/min	14	24	30
B l/min	13	22	29

Kit de ampliación - Extension set: KA2V



2 Vías/Ways

Cartucho Cartridge: 35100 (6689-2) + 4004

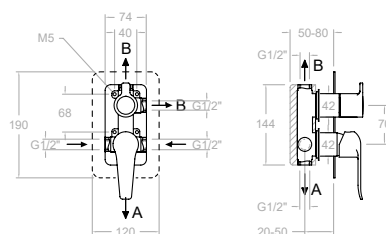
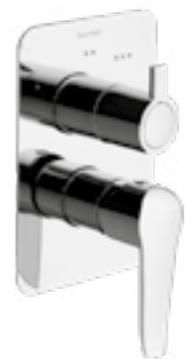

**641503S**  
64C300678

191,50 €

Monomando de ducha empotrado 3 vías con placa metálica.  
Single lever concealed mixer 3 way with ultraslim metallic plate.

XX1503	1bar	3bar	5bar
A l/min	13	22	28
B l/min	13	21	26
B l/min	13	21	26

Kit de ampliación - Extension set: KA3V



3 Vías/Ways

Cartucho Cartridge: 35100 (6689-2) + 4003

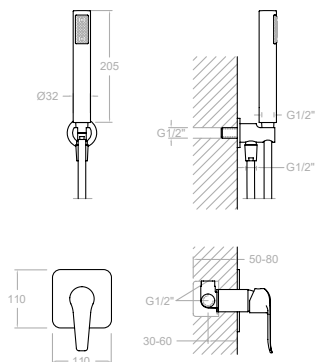
**K6418011**

64D301394

179,90 €

Kit monomando empotrado 1 vía con soporte más toma de agua y teleducha ABS.

Single lever 1 way concealed with support plus water intake and ABS hand shower.



Cartucho Cartridge: 35100 (6689-2)

641801S+3713P+3796+2471C

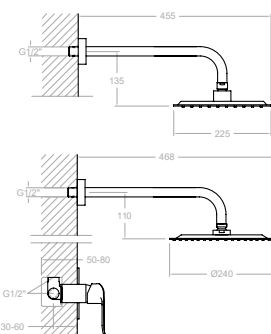
**K6418013**

64D301396

641801S + BNRPK225 (225X225)

213,60 €

**K6418012**

64D301395

641801S + BHRP240 (Ø240)

199,40 €

Kit monomando empotrado 1 vía con rociador mural ABS.

Single lever 1 way with ABS shower head.

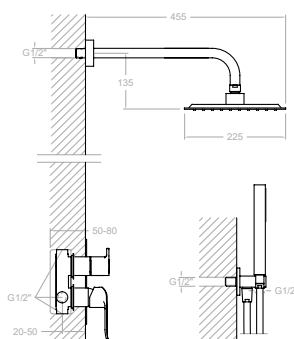

Cartucho Cartridge: 35100 (6689-2)

**K6415022**

64C301487

641502S+ 3713P + 2471C + 3796 + BNRPK225 (225X225)

376,40 €

**K6415021**

64C301397

641502S+ 3713P + 2471C + 3796 + BHRP240 (Ø240)

362,30 €

Conjunto monomando empotrado 2 vías con soporte más toma de agua, teleducha y rociador mural ABS.

Single lever 2 way with support plus water intake, hand shower and ABS shower head.



Cartucho Cartridge: 35100 (6689-2)+ 4004



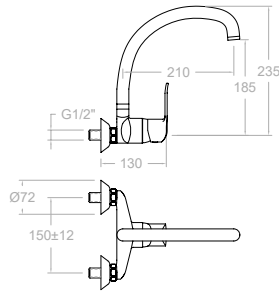

**6417CC**  
260034

94,90 €

Monomando de fregadero mural con caño giratorio.  
Wall sink mixer with above swivel spout.



Cartucho Cartridge: 35100 (6689-2)

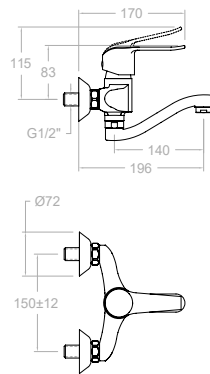

**640702CCB14**  
64E300625

106,40 €

Monomando de fregadero mural con caño bajo conformado corto de 14cm.  
Wall sink mixer with with swivel short spout 14 cm.



Cartucho Cartridge: 35100-3

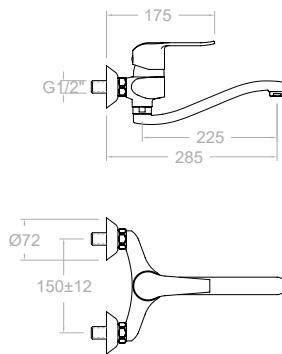

**640702CC**  
64E301621

111,90 €

Monomando de fregadero mural con caño bajo conformado de 22,5 cm.  
Wall sink mixer with swivel spout.



Cartucho Cartridge: 35100-3

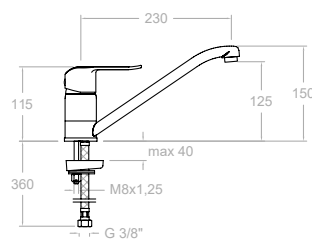

**6499**  
261762

96,10 €

Monomando de fregadero con caño bajo giratorio y sistema de apertura en agua fría.  
Sink mixer with long swivel spout Cold water opening.



Cartucho Cartridge: 40300-2 (3388-2K C3)

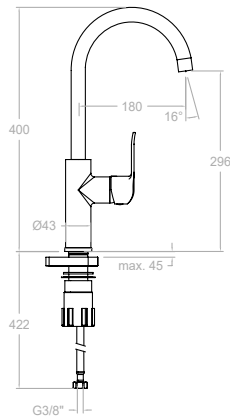

**640602**  
64E301620

122,70 €

Monomando para fregadero.  
Sink mixer with spout.

Cartucho Cartridge: 35100



# Civic

Colección Collection

**N** New





## Características Técnicas

- Certificación AENOR
- Cartucho cerámico Ø35 mm.
- Sistema de ahorro de agua S2 mediante la apertura de la manecilla en dos fases.
- Caudal a 3 bar: 12 l/min.
- Resistente al choque térmico y químico antilegionela.
- Garantía de 5 años en grifería y 3 años en complementos.
- Presión de uso entre 1-5 bar. Recomendada 3 bar.
- Resiste presiones estáticas igual o inferior a 10 bar y golpes de ariete de 25 bar.
- Nivel acústico a 3 bar: inferior a 20 dB.
- Prestaciones de confort a nivel de fidelidad, sensibilidad y constancia en la selección de la temperatura.
- Temperatura recomendada de agua caliente 55°C. Temperatura máxima de uso 65°C. Máximo 1h a 90°C.
- Superficie cromada: 15 micras de espesor de níquel, 0.3 micras de cromo.
- Sistema Termostop Block de limitación de la temperatura máxima del agua caliente.

## Technical Characteristics

- Certification AENOR.
- Ceramic cartridge Ø35 mm.
- Water saving system S2 through the handle opening in two phases.
- Flow rate at 3 bar: 12 l/min.
- Thermal shock resistant and anti-*Legionella* chemical.
- Guarantee of 5 year for tapware and 3 years for accessories.
- Use pressure between 1-5 bar. Recommended pressure 3 bar.
- Resists static pressure equal to or less than 10 bar and water hammer up to 25 bar.
- 3 bar acoustic level less than 20 dB.
- Comfort benefits of fidelity, sensibility and constancy in temperature selection.
- Recommended temperature for hot water: 55°C. Maximum temperature of use: 65°C up to 1 hour at 90°C.
- Chromed surface: 15 microns thick of nickel and 0.3 microns thick of chrome.
- Termostop Black system for maximum water temperature limitation.

## Acabados disponibles Finishing availables



 **Cromo**  
Chrome



Montaje sin herramientas  
Tool-free system



TOOL FREE

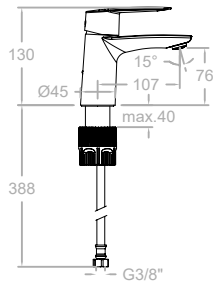

<b>510101</b> 51A307358		<b>52,60 €</b>
Monomando de lavabo Washbasin mixer		
<b>510101VA9065</b> 51A307360	<b>63,20 €</b>	
Monomando de lavabo, con válvula automática 1 1/4. Washbasin mixer with pop-up waste 1 1/4.		
Ref. 9065 ABS		
<b>510101VA1169</b> 51A307359	<b>75,70 €</b>	
Monomando de lavabo, con válvula automática 1 1/4. Washbasin mixer with stainless steel pop-up waste 1 1/4.		
Ref. 1169 INOX		

Cartucho Cartridge: 35100-3



**Ahorro de energía**  
**Apertura en frío**

Energy saving  
Cold opening



TOOL FREE

Cartucho Cartridge: 35300-3

<b>510103</b> 51A307361		<b>52,60 €</b>
Monomando de lavabo con apertura en frío. Washbasin mixer, cold opening.		
<b>510103VA9065</b> 51A307363	<b>63,20 €</b>	
Monomando de lavabo, apertura en frío con válvula automática 1 1/4. Washbasin mixer cold opening with pop-up waste 1 1/4.		
Ref. 9065 ABS		
<b>510103VA1169</b> 51A307362	<b>75,70 €</b>	
Monomando de lavabo, apertura en frío con válvula automática 1 1/4. Washbasin mixer cold opening with stainless steel pop-up waste 1 1/4.		
Ref. 1169 INOX		

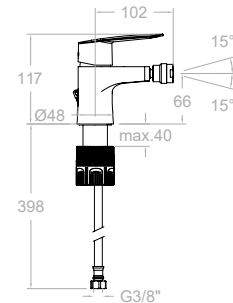

<b>510301</b> 51B307364		<b>53,90 €</b>
Monomando de bidé. Washbasin mixer		
<b>510301VA9065</b> 51B307367	<b>64,60 €</b>	
Monomando de bidé, con válvula automática 1 1/4. Washbasin mixer with pop-up waste 1 1/4.		
Ref. 9065 ABS		
<b>510301VA1169</b> 51B307365	<b>77,20 €</b>	
Monomando de bidé, con válvula automática 1 1/4. Washbasin mixer with stainless steel pop-up waste 1 1/4.		
Ref. 1169 INOX		

Cartucho Cartridge: 35300-3



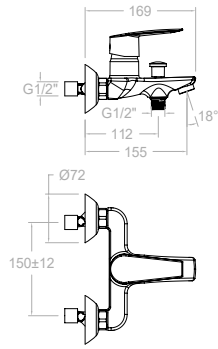

**510501S**  
51C307369

78,40 €

**Monomando de baño-ducha.**  
Bath and shower mixer.



VP

VM



**510501VP2**  
51C307371

94,70 €

510501S+351502+3544+245002C

**510501VM2**  
51C307370

102,00 €

510501S+351502+3544+1128C

**Conjunto monomando de baño-ducha con equipo de ducha.**  
Bath and shower mixer with shower set.



D1



**510501D1**  
51C307368

107,40 €

510501S+3524D1+3544+1128C

**Conjunto monomando de baño-ducha con equipo de ducha.**  
Bath and shower mixer with shower set.

Cartucho Cartridge: 35100

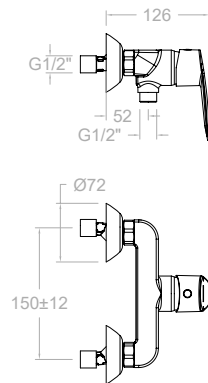

**510801S**  
51D307378

61,50 €

**Monomando de ducha.**  
Shower mixer.



VP

VM



**510801VP2**  
51D307380

77,80 €

510801S+351502+3544+245002C

**510801VM2**  
51D307379

85,10 €

510801S+351502+3544+1128C

**Conjunto monomando de ducha con equipo de ducha.**  
Shower mixer with shower set.



D1



**510801D1**  
51D307372

90,50 €

510801S+3524D1+3544+1128C

**Conjunto monomando de ducha con equipo de ducha.**  
Shower mixer with shower set.

Cartucho Cartridge: 35100-3



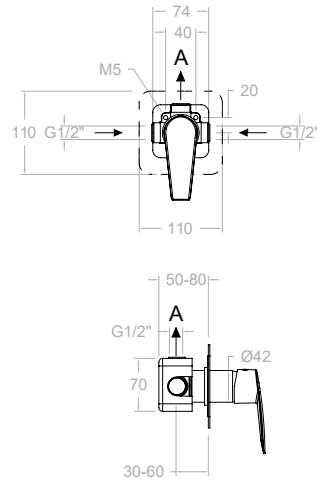

1 Vía/Way

**511801S**

51D307381

XX18010C+5100N-350C-KU10C

82,20 €

Monomando de ducha empotrado metálico 1 vía con placa ultraslim.

Single lever concealed mixer 1 way with ultraslim metal plate.



XX1801	1bar	3bar	5bar
A l/min	17	26	34

Kit de ampliación - Extension set: KA1V

Cartucho Cartridge: 35100 (6689-2)

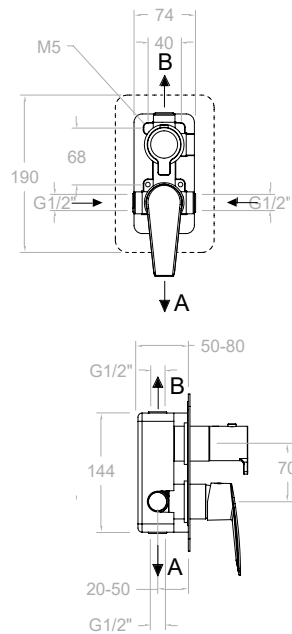

2 Vías/Ways

**511512S**

51D307383

XX15120C+5100N-350C+945000LOC-KU20C

133,60 €

Monomando de ducha empotrado metálico 2 vías con placa ultraslim.

Single lever concealed mixer 2 ways with ultraslim metal plate.



XX1502	1bar	3bar	5bar
A l/min	14	24	30
B l/min	13	22	29

Kit de ampliación - Extension set: KA2V

Cartucho Cartridge: 35100 (6689-2)+4004



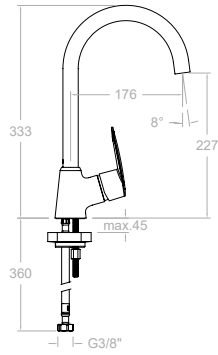

**510602**  
51E307385

76,70 €

Monomando de cocina con caño giratorio.  
Sink mixer with swivel spout.



Cartucho Cartridge: 35100 (6689-2)

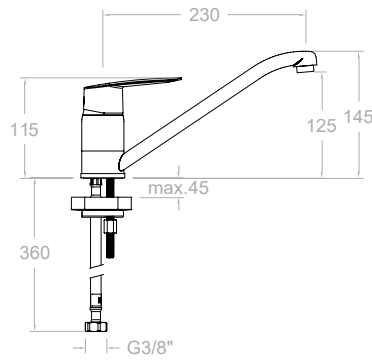

**510901**  
51E307386

64,90 €

Monomando de cocina con caño giratorio.  
Sink mixer with swivel spout.



Cartucho Cartridge: 40200-2

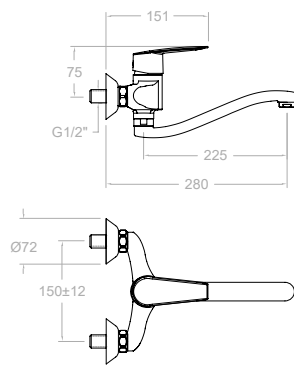

**510701CC**  
51E307388

109,30 €

Monomando de cocina a pared con caño bajo giratorio.  
Wall sink mixer with low swivel spout.



Cartucho Cartridge: 35100-3

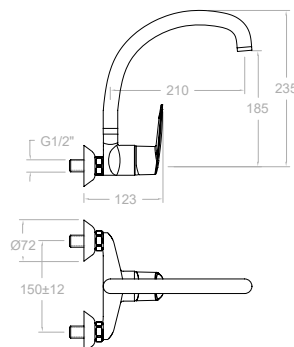

**511701CC**  
51E307387

93,70 €

Monomando de cocina a pared con caño alto giratorio.  
Wall sink mixer with high swivel spout.



Cartucho Cartridge: 35100 (6689-2)

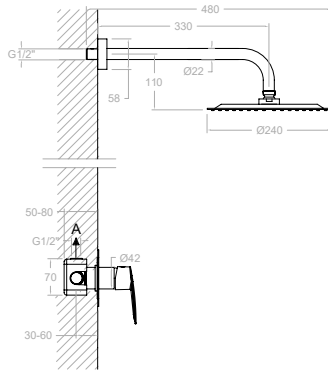

**K5118012**  
51D307390  
511801S-BHRP240

185,90 €

Conjunto monomando empotrado metálico 1 vía con rociador Ø 240 mm.  
Single lever concealed mixer 1 way with ultraslim metal plate.



1 Vía/Way

Cartucho Cartridge: 35100 (6689-2)

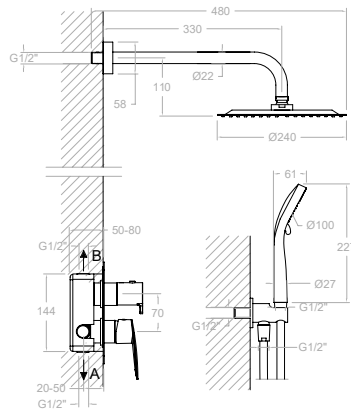

**K5115021**  
51D307391

321,60 €

511512S+BHRP240+3713P+3796+2471C

Conjunto monomando empotrado metálico 2 vías con soporte, toma de agua, ducha de mano y rociador Ø240mm.  
Single lever concealed mixer 2 ways with ultraslim metal plate.



2 Vias/Ways

Cartucho Cartridge: 35100 (6689-2)+4004



# Titanium

Colección Collection



## Características Técnicas

- Cartuchos cerámicos monomando de Ø35mm.
- Cartuchos cerámicos monomando con Sistema Termostop Block de limitación de la temperatura máxima del agua caliente y con Sistema de ahorro de agua (S2-C2) mediante la apertura de la manecilla en dos fases. Disponible en algunos modelos el Sistema de apertura central en frío (S3-C3).
- Caudal a 3 bar: Lavabo, Bidet y Fregadero (de 9 a 12 l/min). Ducha (de 12 a 16 l/min). Baño ( $\geq 20$  l/min).
- Prestaciones de confort a nivel de fidelidad, sensibilidad y constancia en la selección de la temperatura.
- Nivel acústico a 3 bar < 20 dB.
- Cromado latón: 15 micras de espesor de níquel, 0,3 micras de cromo.
- Presión de uso entre 1-5 bar, recomendada 3 bar. Resiste presiones estáticas  $\leq 10$  bar y golpes de ariete de 25 bar.
- Temperatura recomendada de agua caliente 55°C. Temperatura máxima de uso 65°C. Máximo 1h a 90°C.
- Resistente al choque térmico y químico anti-legionela.
- Certificado sanitario ACS.
- Ánodo de sacrificio anticorrosión de zinc-magnesio.

## Technical Characteristics

- Ø35mm ceramic mixer tap cartridge.
- Ceramic mixer tap cartridge with Termostop Block System limiting the maximum temperature of hot water and a water saving system (S2-C2) by a two-phase opening lever. The cold central opening system (S3-C3) is available in some models.
- Flow rate at 3 bar: Washbasin, bidet and sink (from 9 to 12 l/min.); Shower (from 12 to 16 l/min.); and Bath ( $\geq 20$  l/min.).
- Comfortable performance as regards to reliability, sensitivity and reliability in the temperature selection.
- Acoustic level at 3 bar: < 20 dB
- Chrome-plated brass: 15 microns thickness of nickel, 0.3 microns of chrome.
- Working pressure between 1-5 bar, recommended pressure: 3 bar. It resists static pressures  $\leq 10$  bar and pressure oscillations of 25 bar.
- Recommended temperature for the hot water: 55°C. Maximum working temperature: 65°C. Maximum: 1h at 90°C.
- Resistant to thermal and anti-Legionella chemical shocks.
- ACS health compliance certificate.
- Zinc-Magnesium Anti-Corrosion Sacrificial Anode.

Acabado disponible Finishing available



 **Cromo**  
Chrome



Montaje sin herramientas  
Tool-free system



TOOL FREE

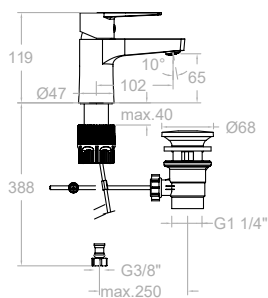

**180102** 47,10 €

18A305345

Monomando de lavabo.  
Washbasin mixer.

**180102VA9065** 57,20 €

18A305346

Monomando de lavabo, con válvula automática 1 1/4\"/>

Ref. 9065 ABS

**180102VA1169** 65,30 €

18A305347

Monomando de lavabo, con válvula automática 1 1/4\"/>

Ref. 1169 INOX

Cartucho Cartridge: 35100-3



### Ahorro de energía Apertura en frío

Energy saving  
Cold opening



TOOL FREE

Cartucho Cartridge: 35300-3

**189102** 57,00 €

18A305348

Monomando de lavabo con apertura en frío.  
Washbasin mixer, cold opening.

**189102VA9065** 67,10 €

18A305349

Monomando de lavabo, apertura en frío con válvula automática 1 1/4\"/>

Ref. 9065 ABS

**189102VA1169** 75,20 €

18A305350

Monomando de lavabo, apertura en frío con válvula automática 1 1/4\"/>

Ref. 1169 INOX



TOOL FREE

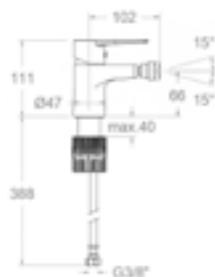

**180302** 48,80 €

18B306079

Monomando de lavabo con apertura en frío.  
Washbasin mixer, cold opening.

**180302VA9065** 59,00 €

18B306081

Monomando de bidé, apertura en frío con válvula automática 1 1/4\"/>

Ref. 9065 ABS

**180302VA1169** 67,00 €

18B306080

Monomando de bidé, apertura en frío con válvula automática 1 1/4\"/>

Ref. 1169 INOX

Cartucho Cartridge: 35100-3

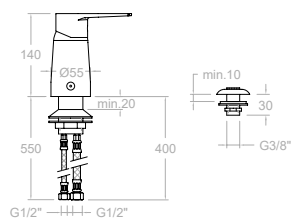

**SA1823** 91,60 €

300320

Monomando de bidé de repisa con duchita.  
Bidet mixer on deck with shower.

Cartucho 40100 (3388)



Venta en el  
Continente Americano  
Available in North, Central  
& South America



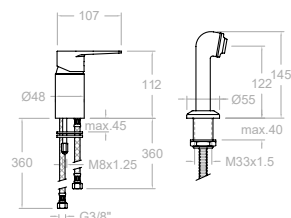

**182201**  
18D301703

170,50 €

Monomando de peluquerías con equipo de ducha.  
Deck mounted bidet mixer with shower.



Cartucho Cartridge: 40101  
182201S+9989SC+9553+2950C

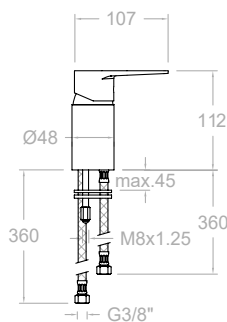

**182201S**  
18D301702

83,70 €

Monomando de peluquerías sin equipo de ducha.  
Deck mounted bidet mixer without shower.



Cartucho Cartridge: 40101

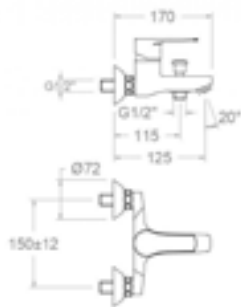

**1805S**

261500

71,20 €

Monomando de baño - ducha sin equipo de ducha.  
Bath and shower mixer without shower kit.



VP

VM



**1805VP2**

18C306229

1805S+351502+3544+245002C

86,50 €

**1805VM2**

18C306230

510501S+351502+3544+1128C

94,30 €

Monomando de baño - ducha con equipo de ducha.  
Bath and shower mixer with shower kit.



D1



**1805D1**

18C306237

1805S + 655501 D1 (3524D1+3544+1128C)

99,80 €

Monomando de baño - ducha con equipo de ducha.  
Bath and shower mixer with shower kit.

Cartucho Cartridge: 35100

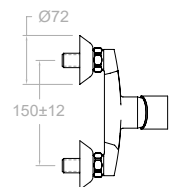
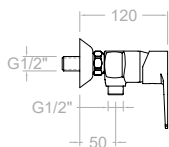

**1808S**

261501

55,80 €

Monomando de ducha sin equipo de ducha.  
Shower mixer without shower set.



VP

VM



**1808VP2**

18D306231

1808S+351502+3544+245002C

71,30 €

**1808VM2**

18D306233

1808S+351502+3544+1128C

78,90 €

Monomando de ducha, con equipo de ducha.  
Shower mixer with shower set.



D1



**1808D1**

18D306238

1808S + (1808S+ 3524D1+3544+1128C)

84,40 €

Monomando de ducha, con equipo de ducha.  
Shower mixer with shower set.

Cartucho Cartridge: 35100-3

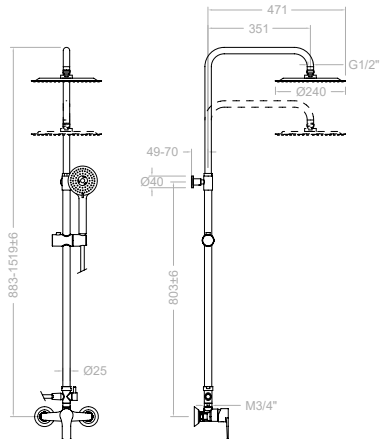

**187402RP240**

18D307081

340,50 €



Columna de ducha telescópica monomando con rociador Ø 240 mm.

Single lever telescopic shower column with headshower Ø 240 mm.

1838S-DN132-IDH1/2-RP240+2876BT+1125C



**BX187402RP240**

18G307082

1.651,70 €



BOX PALET, 5 und. -3% dto. incluido.

BOX PALET, 5 units -3% including discount.

Cartucho Cartridge: 35000-3 (252978)

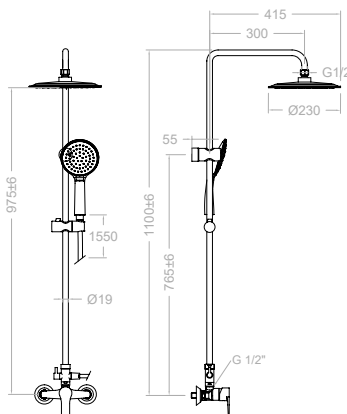

**187802RP230**

18D307937

262,30 €



Columna de ducha fija monomando cromada rociador Ø 240 mm.

Single lever shower column, fix bar, chrome ABS headshower Ø 240 mm.

1838S+T101-IDH1/2-RP230+3525P1+1125C



**BX187802RP230**

18G307939

1.272,20 €



BOX PALET, 5 und. -3% dto. incluido.

BOX PALET, 5 units -3% including discount.

Cartucho Cartridge: 35100-3

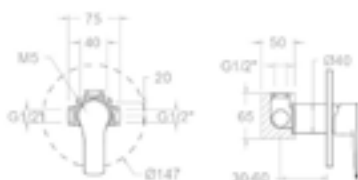
**181801S**

18D300667

73,60 €



**Monomando de ducha empotrado 1 vía con placa metálica.**  
Single lever concealed mixer 1 way with ultraslim metallic plate.

**1 Vía/Way**

XX1801	1bar	3bar	5bar
A l/min	17	26	34

Kit de ampliación - Extension set: KA1V

Cartucho Cartridge: 35100 (6689-2)

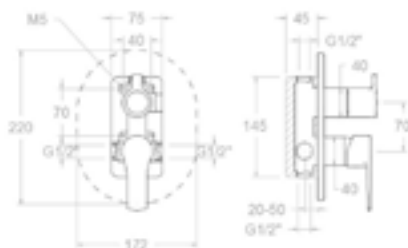
**181502S**

18C300668

119,70 €



**Monomando de ducha empotrado 2 vías con placa metálica.**  
Single lever concealed mixer 2 ways with ultraslim metallic plate.

**2 Vías/Ways**

XX1502	1bar	3bar	5bar
A l/min	14	24	30
B l/min	13	22	29

Kit de ampliación - Extension set: KA2V

Cartucho Cartridge: 35100 (6689-2)+4004

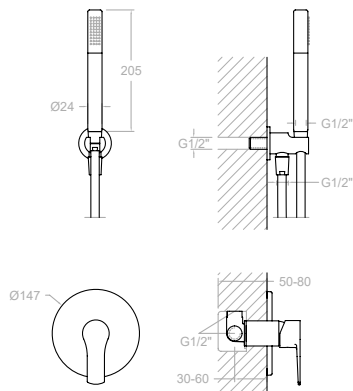

**K1818011**

156,60 €

18D301860

181801S + 3713P + 3796 + 2471C

Conjunto monomando empotrado 1 vía con soporte más toma de agua y teleducha ABS.

Single lever 1 way concealed with support plus water intake and ABS hand shower.



Cartucho Cartridge: 35100 (6689-2)

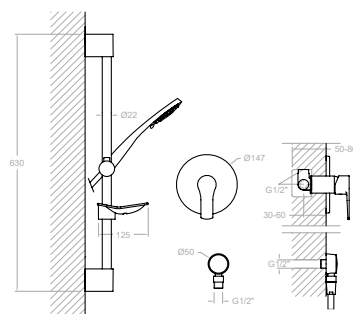

**K1818012**

169,90 €

18D301861

181801S + 982402T3 +9990ARD

Conjunto monomando empotrado 1 vía con monomando empotrado metálico 1 vía con codo de salida de agua, barra, soporte deslizante y teleducha.

Single lever Concealed shower Set 1 way, water intake with support, laton brass wall bar with sliding bracket ABS handshower 3 jets.



Cartucho Cartridge: 35100 (6689-2)

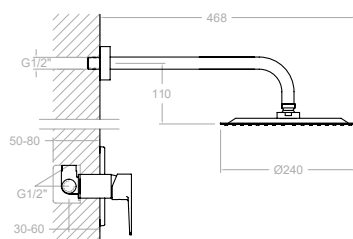

**K1818013**

175,90 €

18D301862

181801S + B350 + RP240

Conjunto monomando empotrado 1 vía con rociador mural ABS Ø 240 mm.

Single lever 1 way concealed with ABS shower head Ø 240 mm.

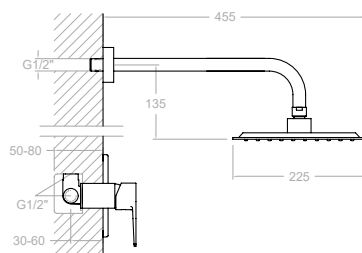

Cartucho Cartridge: 35100 (6689-2)

**K1818014**

18D301863

181801S + B350 + RPK225

190,50 €

Conjunto monomando empotrado 1 vía con rociador mural ABS 225X225.

Single lever 1 way concealed with ABS shower head 225X225.

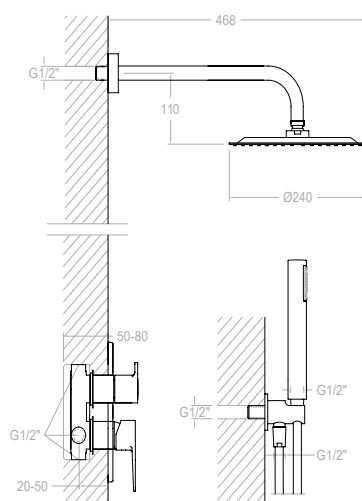

Cartucho Cartridge: 35100 (6689-2)

**K1815021**

18C301864

181502S + B350 + RP240 + 3713P + 3796 + 2471C

304,90 €

Conjunto monomando empotrado 1 vía con rociador mural ABS 225X225.

Single lever 1 way concealed with ABS shower head 225X225.

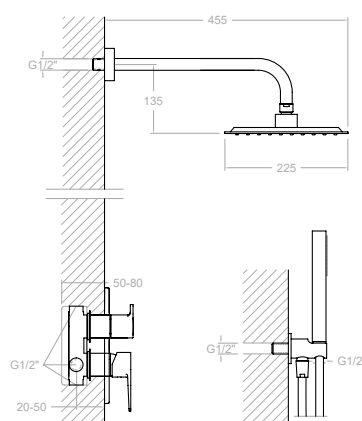

Cartucho Cartridge: 35100 (6689-2) + 4004

**K1815022**

18C301865

181502S + B350 + RPK225 + 3713P + 3796 + 2471C

318,90 €

Conjunto monomando empotrado 1 vía con rociador mural ABS 225X225.

Single lever 1 way concealed with ABS shower head 225X225.



Cartucho Cartridge: 35100 (6689-2) + 4004

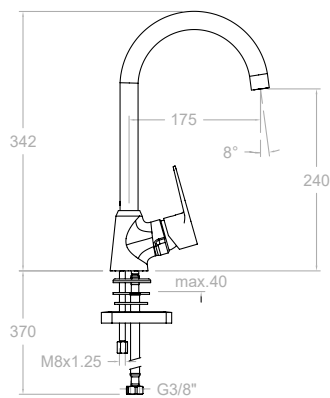

**180602**  
18E303494

70,70 €

Monomando para fregadero vertical con caño cisne.  
Sink mixer with swivel spout.



Cartucho Cartridge: 35100 (6689-2)

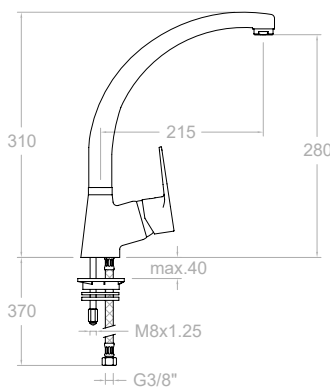

**180601**  
18E300789

71,80 €

Monomando para fregadero con caño giratorio.  
Sink mixer with swivel spout.



Cartucho Cartridge: 35100 (6689-2)

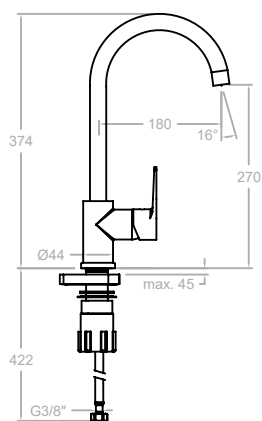

**1836**  
261738

88,50 €

Monomando para fregadero con caño giratorio.  
Sink mixer with swivel spout.



Cartucho Cartridge: 35100 (6689-2)

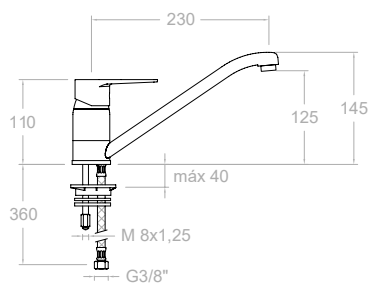

**1809**  
18E300516

59,30 €

Monomando de fregadero con caño giratorio conformado.  
Sink mixer with swivel spout.



Cartucho Cartridge: 40200-2



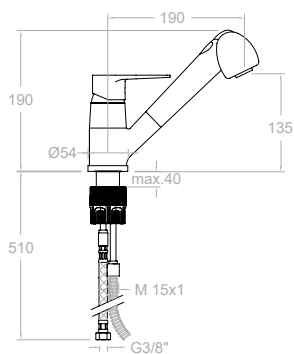

**181901**  
18E307786

162,70 € **N**

Monomando de fregadero mural con caño giratorio.  
Wall mounted sink mixer with swivel spout.



Cartucho Cartridge: 40101-2 (3389)

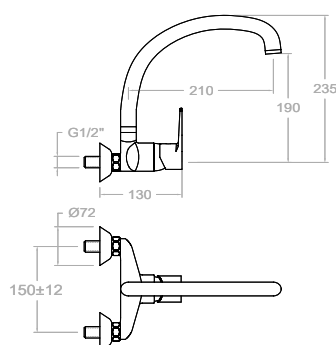

**1817CC**  
18E300794

87,90 €

Monomando de fregadero mural con caño giratorio.  
Wall mounted sink mixer with swivel spout.



Cartucho Cartridge: 35100 (6689-2)

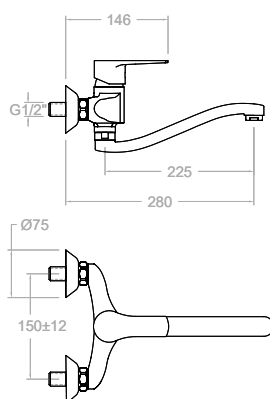

**180701CC**  
18D301705

102,00 €

Monomando de fregadero con caño conformado corto de 22,5 cm.  
Wall sink mixer with with swivel short spout 22,5 cm.



Cartucho Cartridge: 35100-3

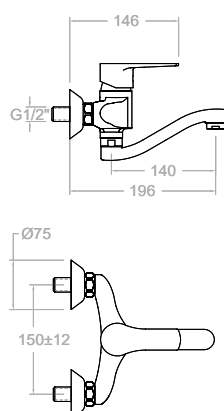

**180701CCB14**  
18E301668

96,90 €

Monomando de fregadero mural con caño giratorio corto de 14 cm.  
Wall sink mixer with swivel spout.



Cartucho Cartridge: 35100-3

# Eco

Colección Collection



## Características Técnicas

- Montura convencional de ½".
- Caudal a 3 bar: Lavabo, Bidet y Fregadero (de 9 a 12 l/min). Ducha (de 12 a 16 l/min). Baño (≥20 l/min).
- Nivel acústico a 3 bar < 20 dB.
- Cromado latón: 15 micras de espesor de níquel, 0,3 micras de cromo.
- Presión de uso entre 1-5 bar, recomendada 3 bar. Resiste presiones estáticas ≤ 10 bar y golpes de ariete de 25 bar.
- Temperatura recomendada de agua caliente 55°C. Temperatura máxima de uso 65°C. Máximo 1h a 90°C.
- Resistente al choque térmico y químico anti-legionela

## Technical Characteristics

- Conventional ½" frame.
- Flow rate at 3 bars: Washbasin, bidet and sink (from 9 to 12 l/min.); Shower (from 12 to 16 l/min.); and Bath (≥20 l/min.).
- Acoustic level at 3 bars: < 20 dB.
- Chrome-plated brass: 15 microns thick of nickel, 0.3 microns of chrome.
- Working pressure between 1-5 bars, recommended: 3 bars. It resists static pressures ≤ 10 bars and water hammers of 25 bars.
- Recommended temperature for the hot water: 55°C. Maximum working temperature: 65°C. Maximum: 1h at 90°C.
- Resistant to thermal and anti-Legionella chemical shocks.



Acabado disponible Finishing available



● Cromo  
● Chrome





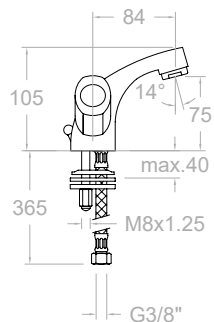

**700112E6** 91,90 €  
70A306297

**Bimando para lavabo.**  
Twin handle wash basin tap.

**700112VA9065E6** 102,50 €  
70A306299

**Bimando para lavabo, con válvula automática 1/4\"**  
Twin handle wash basin tap with pop-up waste 1/4\".

Ref. 9065 ABS



**700112VA1167E6** 114,90 €  
70A306298

**Bimando para lavabo, con válvula automática 1/4\"**  
Twin handle wash basin tap with pop-up waste 1/4\".

Ref. 1167 BRASS

Montura Head: 7800 1/2

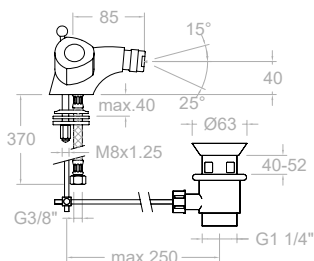

**7003E4** 91,90 €  
803232

**Bimando para bidé.**  
Bidet mixer with shower.

**7003VA9065E4** 102,50 €  
158527

**Bimando para bidé, con válvula automática 1/4\"**  
Bidet mixer with pop-up waste 1/4\".

Ref. 9065 ABS



**7003VA1167E4** 114,90 €  
162087

**Bimando para bidé, con válvula automática 1/4\"**  
Bidet mixer with pop-up waste 1/4\".

Ref. 1167 BRASS

Montura Head: 5000

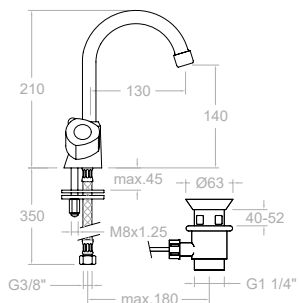

**7010CE10E4** 95,30 €  
803189

**Bimando para lavabo con caño giratorio de tubo.**  
Twin handle wash basin tap with swivel spout.

**7010CE10VA9065E4** 105,90 €  
158475

**Bimando para bidé, con válvula automática 1/4\"**  
Bidet mixer with pop-up waste 1/4\".

Ref. 9065 ABS



**7010CE10VA1167E4** 118,50 €  
162078

**Bimando para bidé, con válvula automática 1/4\"**  
Bidet mixer with pop-up waste 1/4\".

Ref. 1167 BRASS

Montura Head: 5000

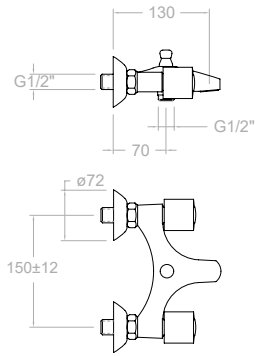

**7006SE4**

161160

109,70 €



Bimando de baño- ducha, sin equipo de ducha.  
Bath and shower without shower set.

Montura Head: 5000

VM



**7006VME4**

803107

134,30 €



Bimando de baño- ducha, sin equipo de ducha.  
Bath and shower without shower set.

7006SE4 + 655402VM2  
655402VM2 (351502+3544+1128C)

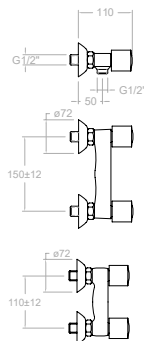

**7004SE4**

156752

85,60 €



Bimando de ducha, sin equipo de ducha.  
Shower without shower set.

**7014SE4**

191526

85,80 €

Bimando de ducha, sin equipo de ducha 110 mm.  
Shower without shower set 110 mm.

Montura Head: 5000

VM



**7004VME4**

803116

110,10 €



Bimando de ducha, sin equipo de ducha 110 cm.  
Shower without shower set 110 cm..

7004SE4 + 655402VM2  
655402VM2 (351502+3544+1128C)

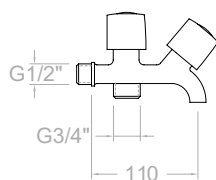
**5079E4A**

153951

57,40 €



Grifo para lavadora de dos salidas.  
Washing machine valve and office valve.

Montura Head: 5000

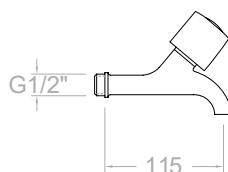
**5070/12E4A**

803768

35,80 €



Grifo para office.  
Office valve.

Montura Head: 5000

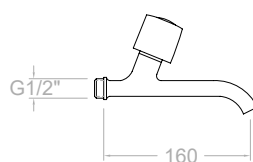
**5070/17E4A**

803820

42,20 €



Grifo para office.  
Office valve.

Montura Head: 5000

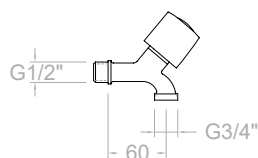
**5069E4A**

803321

30,70 €



Grifo para lavadora, salida roscada 3/4". Agua fría.  
Washing machine valve at 3/4". Cold water.

**5069E4R**

70F303235

30,70 €



Grifo para lavadora, salida roscada 3/4". Agua caliente.  
Washing machine valve at 3/4". Hot water.

Montura Head: 5000



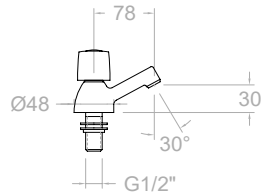

**7012X1E4A**

253545

36,40 €



Grifo para lavabo agua fría.  
Cold water tap for washbasin.



**7012X1E4R**

253554

36,40 €

Grifo para lavabo agua caliente.  
Hot water tap for washbasin.

Montura Head: 5000

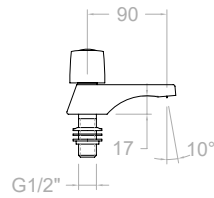
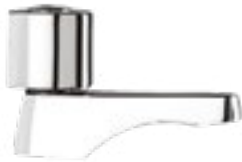

**7002X1E4A**

253491

42,60 €



Grifo para lavabo agua fría.  
Cold water tap for washbasin.



**7002X1E4R**

253500

42,60 €

Grifo para lavabo agua caliente.  
Hot water tap for washbasin.

Montura Head: 5000

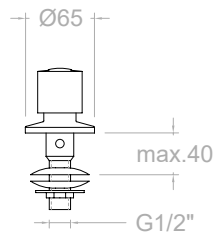

**7005X1E4A**

253509

36,40 €



Grifo para bidé, agua fría.  
Cold water tap for bidet.



**7005X1E4R**

253518

36,40 €

Grifo para bidé, agua caliente.  
Hot water tap for bidet.

Montura Head: 5000

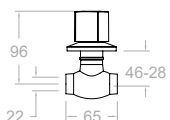
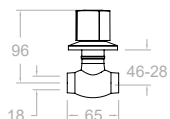
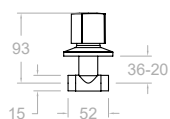
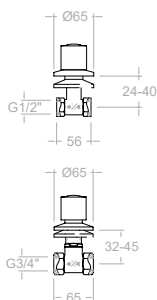

**70071/2X1E4A** 32,10 €  
253473

Llave de paso 1/2" agua fría.  
Cold water stopcock valve at 1/2"

**70071/2X1E4R** 32,10 €  
253482

Llave de paso 1/2" , agua caliente.  
Hot water stopcock valve at 1/2"

Montura Head: 5000

**7007T15X1E4A** 32,10 €  
253392

Llave de paso para soldar tubo Ø15,  
agua fría.  
Cold water stopcock valve at pipe Ø15.

Montura Head: 5000

**7007T18X1E4A** 53,00 €  
253410

Llave de paso para soldar tubo Ø18,  
agua fría.  
Cold water stopcock valve at pipe Ø18.

Montura Head: 6000

**7007T22X1E4A** 53,00 €  
253455

Llave de paso para soldar tubo Ø22,  
agua fría.  
Cold water stopcock valve at pipe Ø22.

Montura Head: 6000

**70073/4X1E4A** 53,00 €  
253374

Llave de paso 3/4" agua fría.  
Cold water stopcock valve at 3/4".

**70073/4X1E4R** 53,00 €  
253383

Llave de paso 3/4" , agua caliente.  
Hot water stopcock valve at 3/4".

Montura Head: 6000

**7007T15X1E4R** 32,10 €  
253401

Llave de paso para soldar tubo Ø15,  
agua caliente.  
Hot water stopcock valve at pipe Ø15.

Montura Head: 5000

**7007T18X1E4R** 53,00 €  
253446

Llave de paso para soldar tubo Ø18,  
agua caliente.  
Hot water stopcock valve at pipe Ø18.

Montura Head: 6000

**7007T22X1E4R** 53,00 €  
253464

Llave de paso para soldar tubo Ø22,  
agua caliente.  
Hot water stopcock valve at pipe Ø22.

Montura Head: 6000

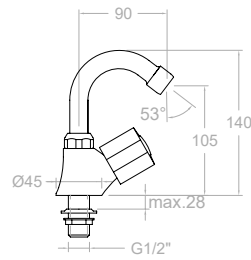

**7028X1CE11E4A**

261614

60,90 €

Grifo 1 agua fría para bidet, con caño giratorio de tubo.  
Single bidet with swivel spout for cold water.



**7028X1CE11E4R**

261303

60,90 €

Grifo 1 agua caliente para bidet, con caño giratorio de tubo.  
Single bidet with swivel spout for hot water.

Montura Head: 5000

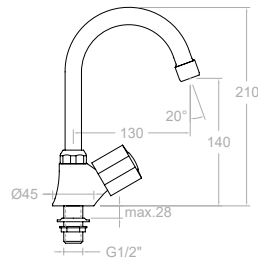

**7028X1CE10E4A**

261613

60,90 €

Grifo 1 agua fría para fregadero, con caño giratorio de tubo.  
Single sink tap high swivel spout for cold water.



**7028X1CE10E4R**

261294

60,90 €

Grifo 1 agua caliente para fregadero, con caño giratorio de tubo.  
Single sink tap high swivel spout for hot water.

Montura Head: 5000

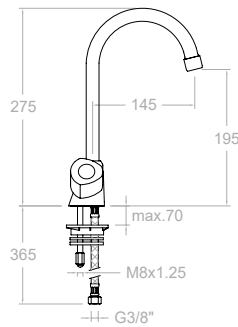

**7008CE08YE4**

803278

93,80 €

Bimando para fregadero con caño giratorio.  
Twin handle sink tap with high swivel spout.



Montura Head: 5000

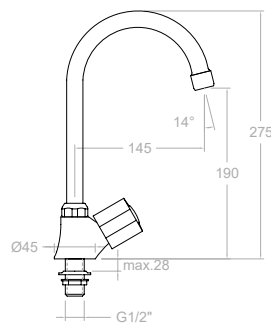

**7028X1CE08YE4A**

261611

60,90 €

Grifo 1 agua fría para fregadero, con caño giratorio de tubo.  
Single sink tap high swivel spout for cold water.



**7028X1CE08YE4R**

261276

60,90 €

Grifo 1 agua caliente para fregadero, con caño giratorio de tubo.  
Single sink tap high swivel spout for hot water.

Montura Head: 5000

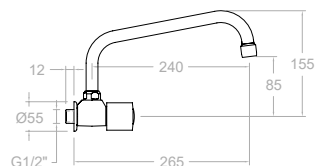
**7029X1CAI30E4A**

261715

59,60 €



Grifo 1 agua fría para fregadero mural, con caño giratorio de tubo.

Wall single sink tap with swivel spout for cold water.

**7029X1CAI30E4R**

261366

59,60 €

Grifo 1 agua caliente para fregadero mural, con caño giratorio de tubo.

Wall single sink tap with swivel spout for hot water.

Montura Head: 5000

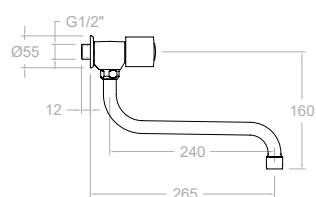
**7029X1CB30E4A**

261717

59,60 €



Grifo 1 agua fría para fregadero mural, con caño giratorio de tubo.

Wall single sink tap with swivel spout for cold water.

**7029X1CB30E4R**

261384

59,60 €

Grifo 1 agua caliente para fregadero mural, con caño giratorio de tubo.

Wall single sink tap with swivel spout for hot water.

Montura Head: 5000

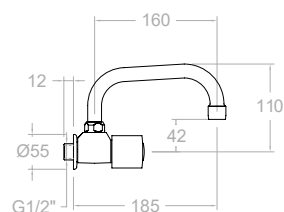
**7029X1CA21E4A**

261711

57,70 €



Grifo 1 agua fría para fregadero mural, con caño giratorio de tubo.

Wall single sink tap with swivel spout for cold water.

**7029X1CA21E4R**

261330

57,70 €

Grifo 1 agua caliente para fregadero mural, con caño giratorio de tubo.

Wall single sink tap with swivel spout for hot water.

Montura Head: 5000

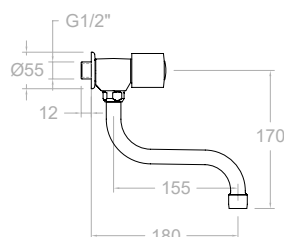
**7029X1CB21E4A**

261713

57,70 €



Grifo 1 agua fría para fregadero mural, con caño giratorio de tubo.

Wall single sink tap with swivel spout for cold water.

**7029X1CB21E4R**

261348

57,70 €

Grifo 1 agua caliente para fregadero mural, con caño giratorio de tubo.

Wall single sink tap with swivel spout for hot water.

Montura Head: 5000

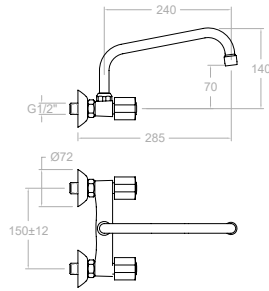

**7009CAI30E4**  
803287

99,90 €



Bimando para fregadero mural con caño giratorio inclinado.  
Wall twin handle sink with swivel spout.

Montura Head: 5000

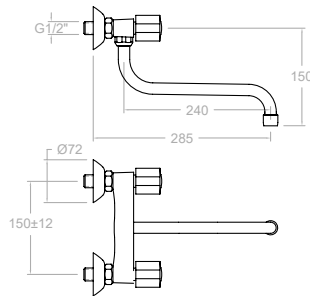

**7009CB30E4**  
803296

99,90 €



Bimando para fregadero mural con caño giratorio inclinado.  
Wall twin handle sink with swivel spout.

Montura Head: 5000

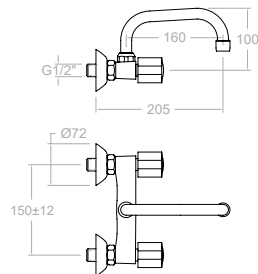

**7009CA21E4**  
803893

96,70 €



Bimando para fregadero mural con caño giratorio inclinado.  
Wall twin handle sink with swivel spout.

Montura Head: 5000

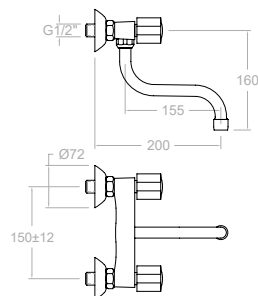

**7009CB21E4**  
155441

96,70 €



Bimando para fregadero mural con caño giratorio inclinado.  
Wall twin handle sink with swivel spout.

Montura Head: 5000

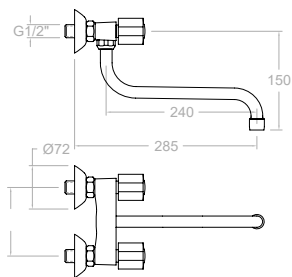
**7019CB30E4**

803312

99,90 €



Bimando para fregadero mural (8,5 - 13,5), con caño giratorio.  
Wall twin handle sink with low spout, with 8,5 - 13,5 cm excentric.

Montura Head: 5000

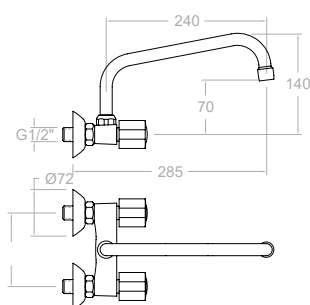
**7019CAI30E4**

803303

99,90 €



Bimando para fregadero mural 110 mm, con caño giratorio.  
Wall twin handle sink with low spout, with 8,5 - 13,5 cm excentric.

Montura Head: 5000

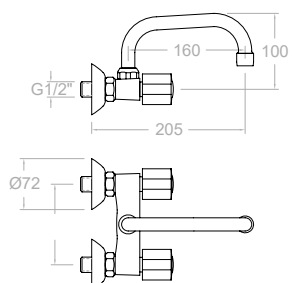
**7019CA21E4**

803964

96,70 €



Bimando para fregadero mural 110 mm, con caño giratorio.  
Wall twin handle sink with low spout, with 8,5 - 13,5 cm excentric.

Montura Head: 5000

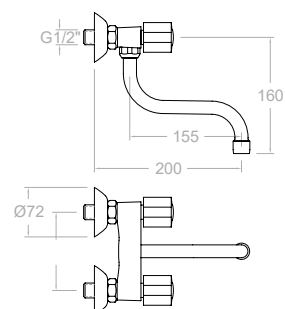
**7019CB21E4**

155502

96,70 €



Bimando para fregadero mural (8,5 - 13,5), con caño giratorio.  
Wall twin handle sink with low spout, with 8,5 - 13,5 cm excentric.

Montura Head: 5000

# Termotech

Colección Collection





## Características Técnicas

- Cartuchos cerámicos monomando.
- Ø35mm en Ducha, Baño-ducha, Fregadero mural, Fregadero vertical, Ducha empotrado y Baño-ducha empotrado.
- Ø40mm en Lavabos, Bidé, Fregaderos extraíble.
- Cartuchos cerámicos monomando con Sistema Termostop Block de limitación de la temperatura máxima del agua caliente y con Sistema de ahorro de agua (S2-C2) mediante la apertura de la manecilla en dos fases. Disponible en algunos modelos el Sistema de apertura central en frío (S3-C3).
- Caudal a 3 bar: Lavabo, Bidet y Fregadero (de 9 a 12 l/min). Ducha (de 12 a 16 l/min). Baño ( $\geq 20$  l/min).
- Prestaciones de confort a nivel de fidelidad, sensibilidad y constancia en la selección de la temperatura.
- Nivel acústico a 3 bar < 20 dB.
- Cromado latón: 15 micras de espesor de níquel, 0,3 micras de cromo.
- Presión de uso entre 1-5 bar, recomendada 3 bar. Resiste presiones estáticas  $\leq 10$  bar y golpes de ariete de 25 bar.
- Temperatura recomendada de agua caliente 55°C. Temperatura máxima de uso 65°C. Máximo 1h a 90°C.
- Resistente al choque térmico y químico anti-legionela.
- Certificado sanitario ACS.
- Ánodo de sacrificio anticorrosión de zinc-magnesio.

## Technical Characteristics

- Ceramic mixer tap cartridge.
- Ø35mm for showers, bath-showers, vertical sinks, embedded showers and embedded bath-showers.
- Ø40mm for washbasins, bidets, removable sinks.
- Ceramic mixer tap cartridge with Termostop Block System limiting the maximum temperature of hot water and a water saving system (S2-C2) by a two-phase opening lever. The cold central opening system (S3-C3) is available in some models.
- Flow rate at 3 bar: Washbasin, bidet and sink (from 9 to 12 l/min.); Shower (from 12 to 16 l/min.); and Bath ( $\geq 20$  l/min.).
- Comfortable performance as regards to reliability, sensitivity and reliability in the temperature selection.
- Acoustic level at 3 bar: < 20 dB
- Chrome-plated brass: 15 microns thickness of nickel, 0.3 microns of chrome.
- Working pressure between 1-5 bar, recommended pressure: 3 bar. It resists static pressures  $\leq 10$  bar and pressure oscillations of 25 bar.
- Recommended temperature for the hot water: 55°C. Maximum working temperature: 65°C. Maximum: 1h at 90°C.
- Resistant to thermal and anti-Legionella chemical shocks.
- ACS health compliance certificate.
- Zinc-Magnesium Anti-Corrosion Sacrificial Anode.

**Acabado disponible** Finishing available



**Cromo**  
Chrome





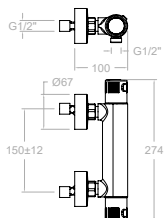

**963402S** 140,40 €  
96D303541

Termostático de ducha.  
Thermostatic shower mixer without shower set.

Cartucho Cartridge: 1703T+1700C1/2



**EXPOTER2+ CX963402SX6** 817,30 €  
MKX302625+ 96G304820

Expositor dispensador de termostática Termotech + 6 und. termostática.

Exhibitor container of thermostatic Box+ 6 und. thermostatic.



NL

**963402NL** 182,00 €  
96D303911

Termostático de ducha con equipo de ducha.  
Thermostatic shower mixer with shower set.



BT

**963402BT** 186,20 €  
96D304395

Termostático de ducha con equipo de ducha.  
Thermostatic shower mixer with shower set.

Cartucho Cartridge: 1703T+1700C1/2



**EXPOTER4+ CX963402BTX6** 1.061,70 €  
MKX304398+ 96G304396

Expositor dispensador de termostática Termotech + 6 und. termostática.

Exhibitor container of thermostatic Box+ 6 und. thermostatic.



**969402BT** 213,70 €  
96D305382

Termostático de ducha con equipo de ducha.  
Thermostatic shower mixer with shower set.

Cartucho Cartridge: 1703T+1700C1/2



**EXPOTER4+ CX963402BTX6** 1.061,70 €  
MKX304398+ 96G304396

Expositor dispensador de termostática Termotech + 6 und. termostática.

Exhibitor container of thermostatic Box+ 6 und. thermostatic.

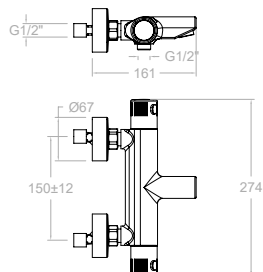

**963901S**  
96C302243

197,60 €

**Termostático de baño-ducha.**  
Thermostatic bath and shower mixer without shower set.



Cartucho Cartridge: 1703T + 4000



NL

**963901NL**  
96C302566

239,20 €

**Termostático de ducha con equipo de ducha.**  
Thermostatic shower mixer with shower set.



963901S + 3521NL + 3547 + 1128C

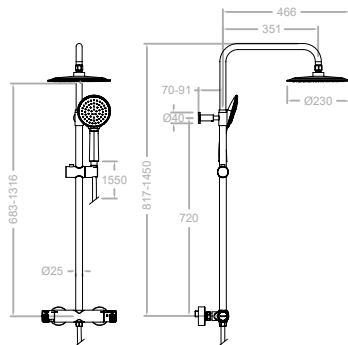

**965402RP230**

442,90 € **N**

96D306604

961202S+DN132D+RP230+3525P1+1125C



**965402RP230NM**

664,40 € **N**

96D306654

961202SNM+DN132DNM+RP230NM+2879D3NM+2476CNM

Columna de ducha telescópica termostática rociador Ø230 mm.  
Thermostatic telescopic shower column with headshower Ø230 mm.

Cartucho Cartridge: 1703T + 4000

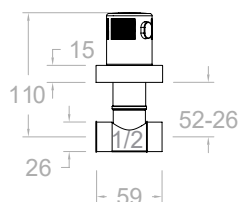

**960701A1/2" (x1)**

21,00 €

96F307777

Llave de paso de 1/2".  
1/2" angle valve.



Montura Head: 5000

**960701R1/2" (x1)**

21,00 €

96F307778

Llave de paso de 1/2".  
1/2" angle valve.



Montura Head: 5000

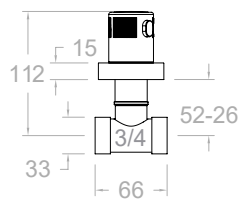

**960701A3/4" (x1)**

21,00 €

96F307779

Llave de paso de 3/4".  
3/4" angle valve.



Montura Head: 6000

**960701R3/4" (x1)**

21,00 €

96F307781

Llave de paso de 3/4".  
3/4" angle valve.



Montura Head: 6000



# Blautherm

Colección Collection



## Características Técnicas

- Cartucho cerámico Ø35 mm.
- Cartucho Termostático con Sistema Hot Block de seguridad antiquemaduras.
- Distribuidor 2 vias sin cierre
- Sistema de ahorro de agua S2 mediante la apertura de la manecilla en dos fases.
- Caudal a 3 bar: Salida baño 20 l/min, 12 l/min en salida teleducha y 16 l/min en salida rociador.
- Resistente al choque térmico y químico antilegionela.
- Presión de uso entre 1-5 bar. Recomendada 3 bar.
- Instalación mínima recomendada con calentadores a gas o eléctricos a partir de 10 litros y una potencia de 18 Kw.
- Resiste presiones estáticas igual o inferior a 10 bar y golpes de ariete de 25 bar.
- Nivel acústico a 3 bar: inferior a 20 dB.
- Prestaciones de confort a nivel de fidelidad, sensibilidad y constancia en la selección de la temperatura.
- Temperatura recomendada de agua caliente 55°C. Temperatura máxima de uso 65°C. Máximo 1h a 90°C.
- Superficie cromada: 15 micras de espesor de níquel, 0.3 micras de cromo.

## Technical Characteristics

- Ceramic cartridge Ø35 mm.
- Thermostatic cartridge with Hot Block system for anti burn safety.
- Diverter 2 ways without closure.
- Water saving system S2 through the handle opening in two phases.
- Flow rate at 3 bar: 20 l/min through bath outlet, 12 l/min through hand shower outlet and 16 l/min through showerhead outlet.
- Thermal shock resistant and anti-Legionella chemical.
- Use pressure between 1-5 bar. Recommended pressure 3 bar.
- Minimum installation required with gas or electrical water heaters from 10 liters with 18 Kw of power.
- Resists static pressure equal to or less than 10 bar and water hammer up to 25 bar.
- 3 bar acoustic level less than 20 dB.
- Comfort benefits of fidelity, sensibility and constancy in temperature selection.
- Recommended temperature for hot water: 55°C. Maximum temperature of use: 65°C up to 1 hour at 90°C.
- Chromed surface: 15 microns thick of nickel and 0.3 microns thick of chrome.

## Acabados disponibles Finishing availables



**Cromo**  
Chrome



**Negro mate**  
Black matte



**Oro cepillado**  
Brushed gold







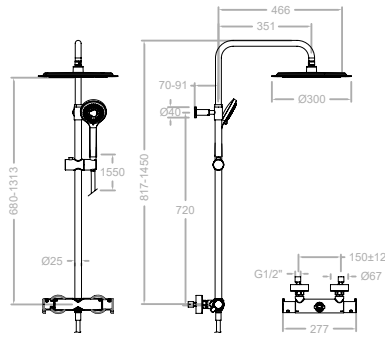

Oro cepillado disponible en Julio  
Brushed gold available in July

**945412RP300** 517,80 € **N**

94D306802  
941202S+DN132D+RP300+2876BT+2478C

**945412RP300NM** 776,70 € **N**

94D306803  
941202SNM+DN132DNM+RP300NM+2876BTNM+2475CNM

**945412RP300OC** 906,20 € **N**

94D307342  
941202SOC+DN132DOC+RP300OC+4914Q3OC+2475COC

Columna de ducha telescópica termostática rociador Ø 300 mm.  
Thermostatic telescopic shower column with headshower Ø 300 mm.

Cartucho Cartridge: 1703T + 4000

**BX945412RP300** 2.511,40 €

94G306801

**BX945412RP300NM** 3.767,20 €

94G306804

**BX945412RP300OC** 4.395,00 €

94G307822

BOX PALET, 5 unidades -3% Descuento especial incorporado.  
BOX PALET, 5 units - 3% Special discount in the price.

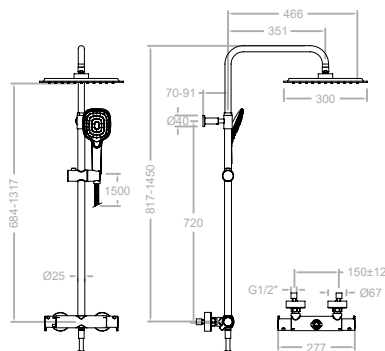

Disponible en Julio  
Available in July

**945412RPK300** 529,60 € **N**

94D307344  
941202S+DN132D+RPK300+4914Q3+2478C

**945412RPK300NM** 794,40 € **N**

94D307345  
941202SNM+DN132DNM+RPK300NM+4914Q3NM+2475CNM

**945412RPK300OC** 926,80 € **N**

94D307346  
941202SOC+DN132DOC+RPK300OC+4914Q3OC+2475COC

Columna de ducha telescópica termostática rociador cuadrado 300 mm.  
Thermostatic telescopic shower column with squared headshower 300 mm.

Cartucho Cartridge: 1703T + 4000

**BX945412RPK300** 2.568,54 €

94G307823

**BX945412RPK300NM** 3.852,80 €

94G307824

**BX945412RPK300OC** 4.494,90 €

94G307826

BOX PALET, 5 unidades -3% Descuento especial incorporado.  
BOX PALET, 5 units - 3% Special discount in the price.



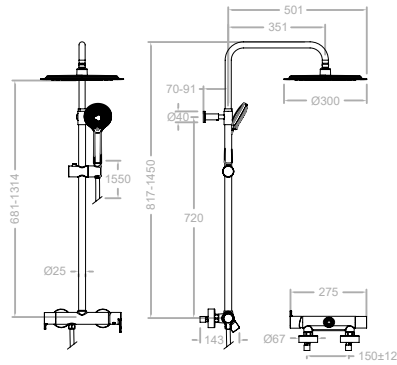

Oro cepillado disponible en Julio  
Brushed gold available in July

**937413RP300** 423,30 € **N**  
94D306809  
932803S+DN132D+RP300+2876BT+1128C

**937412RP300NM** 634,90 € **N**  
94D306811  
932803SNM+DN132DNM+RP300NM+2876BTNM+2475CNM

**937412RP300OC** 740,70€ **N**  
94D307349  
932803SOC+DN132DOC+RP300OC+4914Q3OC+2475COC

Columna de ducha telescópica monomando rociador Ø 300 mm.  
Single lever telescopic shower column with headshower Ø 300 mm.

Cartucho Cartridge:35100 (6689-2)+ 4004



**BX937413RP300** 2.052,90 €  
94G306810

**BX937412RP300NM** 3.079,30 €  
94G306812

**BX937412RP300OC** 3.592,50 €  
94G307827

BOX PALET, 5 unidades -3% Descuento especial incorporado.  
BOX PALET, 5 units - 3% Special discount in the price.

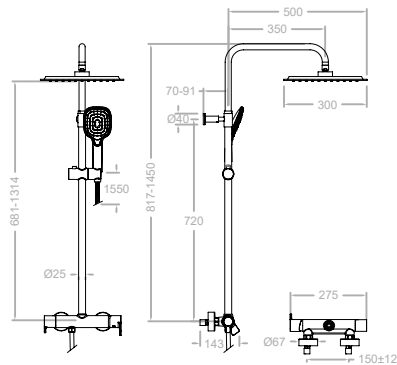

Disponible en Julio  
Available in July

**937413RPK300** 436,30 € **N**  
94D307351  
932803S+DN132D+RPK300+4914Q3+1128C

**937412RPK300NM** 654,50 € **N**  
94D307352  
932803SNM+DN132DNM+RPK300NM+4914Q3NM+2475CNM

**937412RPK300OC** 763,60 € **N**  
94D307353  
932803SOC+DN132DOC+RPK300OC+4914Q3OC+2475COC

Columna de ducha telescópica monomando rociador cuadrado 300 mm.  
Single lever telescopic shower column with squared headshower 300 mm.

Cartucho Cartridge:35100 (6689-2)+ 4004



**BX937413RPK300** 2.116,10 €  
94G307828

**BX937412RPK300NM** 3.174,30 €  
94G307829

**BX937412RPK300OC** 3.703,10 €  
94G307830

BOX PALET, 5 unidades -3% Descuento especial incorporado.  
BOX PALET, 5 units - 3% Special discount in the price.



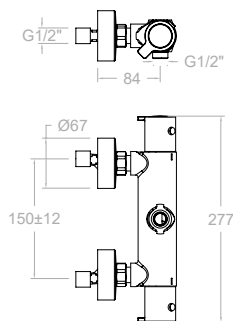

<b>941202S</b> 94D302999	221,10 €
<b>941202SNM</b> 94D303395	331,70 €
<b>941202SOC</b> 94D308061	386,90 €

Monomando baño-ducha con inversor integrado sin equipo de ducha.  
Bath-shower with integrated diverter.

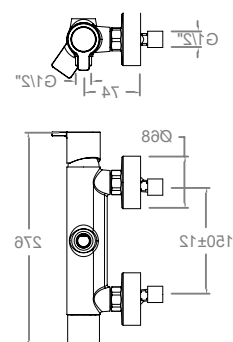

<b>932803S</b> 94D306820	182,20 €
<b>932802S</b> 94D303651	182,20 €
<b>932802SNM</b> 94D303652	273,30 €
<b>932802SOC</b> 94D303902	318,90 €

Monomando baño-ducha con inversor integrado sin equipo de ducha.  
Bath-shower with integrated diverter.

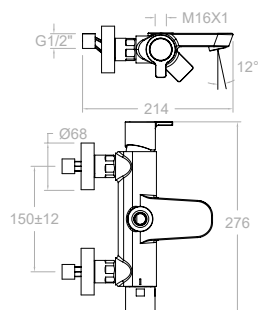

<b>9346S</b> 94C301682	279,60 €
<b>9346SNM</b> 94C304983	419,50 €

Monomando baño-ducha con inversor integrado sin equipo de ducha.  
Bath-shower with integrated diverter.

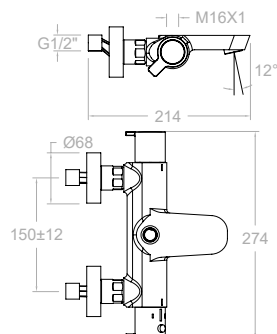

<b>9446S</b> 94C301683	339,60 €
<b>9446SNM</b> 94C304984	509,50 €

Termostático baño-ducha con inversor integrado sin equipo de ducha.  
Thermostatic bath-shower

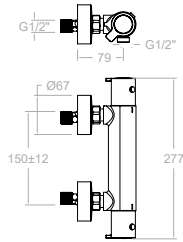

**943404S** 152,20 €  
94D305528

**943404SNM** 228,30 € **N**  
94D307782

Termostático de ducha sin equipo de ducha.  
Thermostatic shower mixer without shower kit.

Cartucho Cartridge:1701T + 1700C1/2"

**EXPOTER1**  
MKX302625

Dispensador blautherm.  
Exhibitor container.

**CX943404SX6** 885,80 €  
94G305529

6 und. termostática blautherm.  
6 und. thermostatic blautherm.



**BT**



**943404BT** 198,10 €  
94D305533

**943404BTNM** 377,40 € **N**  
94D307783

Termostático de ducha con equipo de ducha.  
Thermostatic shower mixer with shower kit.

943404S+2876BT+3726+1128C

**EXPOTER3**  
MKX303400

Dispensador blautherm.  
Exhibitor container.

**CX943404BTX6** 1.152,90 €  
94G305530

6 und. termostática blautherm.  
6 und. thermostatic blautherm.



**T1**

**943404T1** 196,10 €  
94D305531

Termostático de ducha con equipo de ducha.  
Thermostatic shower mixer with shower kit.

Montura Head: 1701C1/2 + 1702C1/2  
943404S+3520T1+3726+2471C





T3

**943404T3**

94D305532

202,30 €

Termostático de ducha con equipo de ducha.  
Thermostatic shower mixer with shower kit.



943404S+5840T3+3726+2471C

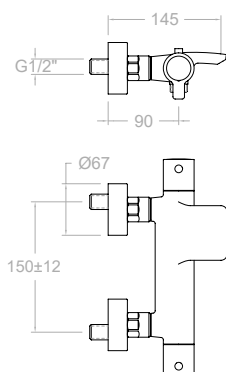

**943901S**

261649

232,30 €

Termostático de baño - ducha con cascada e inversor integrado, sin equipo de ducha.  
Bathtub thermostatic with cascade stream, without shower kit.



Cartucho Cartridge:1701 T + 4001



T1

**943901T1**

261652

276,10 €

Termostático de baño - ducha con cascada e inversor integrado, con equipo de ducha.  
Bathtub thermostatic with cascade stream, with a shower set.



943901S+3520T1+3726+2471C



T3

**943901T3**

94C301946

282,20 €

Termostático de baño - ducha con cascada e inversor integrado, con equipo de ducha.  
Bathtub thermostatic with cascade stream, with a shower set.



943901S+5840T3+3726+2471C



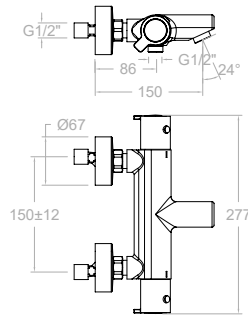

**943801S** 199,50 €

94C302075

**943801SNM** 299,30 € **N**

94C307784

Termostático de baño- ducha, sin equipo de ducha.  
Bathtub thermostatic without shower kit.



Cartucho Cartridge: 1701 T + 4000



**T1**

**943801T1** 243,40 €

94C302571

Termostático de baño- ducha con inversor integrado, con equipo de ducha.  
Bathtub thermostatic with a shower set.



943801S+3520T1+3726+2471C



**T3**

**943801T3** 249,60 €

94C302572

Termostático de baño- ducha con inversor integrado, con equipo de ducha.  
Bathtub thermostatic with a shower set.



943801S+5840T3+3726+2471C



**BT**

**943801SBTNM** 448,40 € **N**

94C307785

Termostático de baño - ducha con cascada e inversor integrado, con equipo de ducha.  
Bathtub thermostatic with cascade stream, with a shower set.



943801SNM+2876BTNM+372602NM+2475CNM

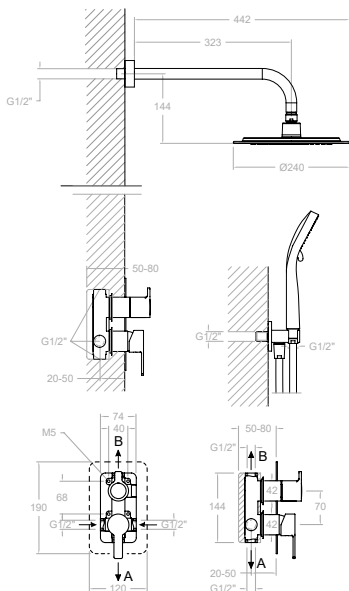
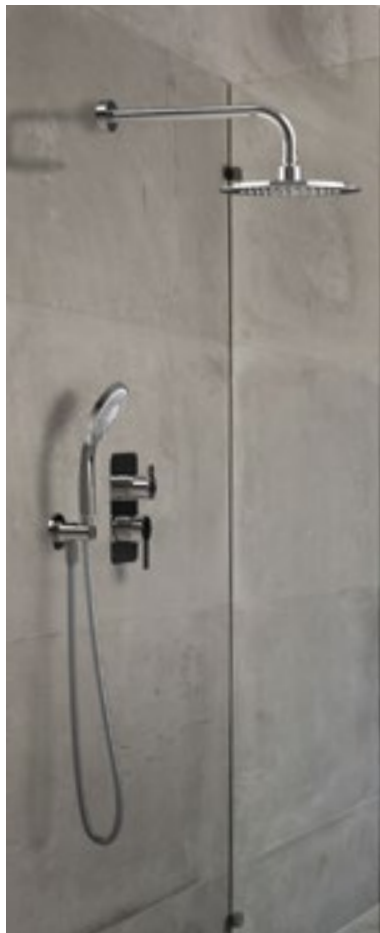

**941502RP240**

293,70 €

94C301586

941502S+BHRP240+2876BT+3796+2471C

**941502RP240NM**

440,50 €

94D303675

941502SNM+BHRP240NM+2876BTNM+3796NM+2475CNM

Conjunto monomando empotrado 2 vías con soporte más toma de agua, teleducha y rociador mural ABS Ø 240 mm.

Concealed wall single lever 2 way with wall elbow shower support hand shower and wall arm ABS shower head Ø 240 mm.



**941502RM250**

414,50 €

94D302556

941502S+BHRM250+2876BT+3796+2471C

Conjunto monomando empotrado 2 vías con soporte más toma de agua, teleducha y rociador mural INOX Ø 250 mm.

Single lever mixer 2 way concealed with support plus water intake, han shower and STEEL shower head Ø 250 mm.

**941801S**

72,50 €

94D301584

XX1801+940001N-35+KX1

Empotrado monomando 1 vía.

Single lever 1 way concealed.

**941502S**

117,90 €

94C301585

XX1502+940001N-35+945100+KX2

**941502SNM**

176,90 €

94C303682

XX1502NM+940001N-35NM+945100NM+KX2NM

Empotrado monomando 2 vías.

Single lever 2 way concealed.

941502	1bar	3bar	5bar
A l/min	14	24	30
B l/min	13	22	29

Kit de ampliación - Extension set: KA2V

Cartucho Cartridge: 35100 + 4004

**BX941502RP240**

1.709,40 €

94G301706

**BX941502RP240NM**

2.564,60 €

94G303677

**BX941502RM250**

2.412,00 €

94G302557

BOX PALET, 6 unidades -3% Descuento especial incorporado.

BOX PALET, 6 units - 3% Special discount in the price.



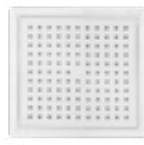
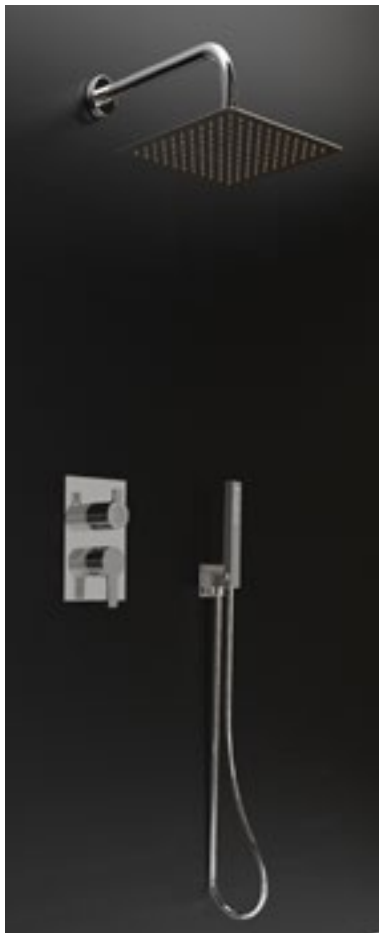

RPK225



**941502RPK225**

330,60 €

94C301587

941502KS+RPK225+B350+4716PR+4796+2471C

Conjunto monomando empotrado 2 vías con soporte más toma de agua, teleducha y rociador mural ABS cuadrado 225x225mm. Concealed wall single lever 2 way with wall elbow shower support hand shower and wall arm ABS shower head 225x225 mm.



RK250



**941502RK250**

416,50 €

94D302558

941502KS+B350+RK250+4716PR+4796+2471C

Conjunto monomando empotrado 2 vías con soporte más toma de agua, teleducha y rociador mural ABS cuadrado 250x250mm. Concealed wall single lever 2 way with wall elbow shower support hand shower and wall arm ABS shower head 250x250 mm.

**941801KS**

79,80 €

94D301699

XX1801+940001N+35+K1

Empotrado monomando 1 vía. Single lever 1 way concealed.

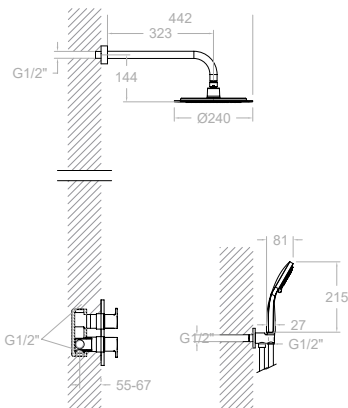

**941502KS**

129,70 €

94C301700

XX1502+945100+940001N-35+K2

Empotrado monomando 2 vías. Single lever 2 way concealed.

941502	1bar	3bar	5bar
A l/min	14	24	30
B l/min	13	22	29

Kit de ampliación - Extension set: KA1V

Cartucho Cartridge: 35100 + 4004



**BX941502RPK225**

1.923,90 €

94G301707

**BX941502RK250**

2.424,30 €

94G302559

BOX PALET, 6 unidades - 3% Descuento especial incorporado. BOX PALET, 6 units - 3% Special discount in the price.



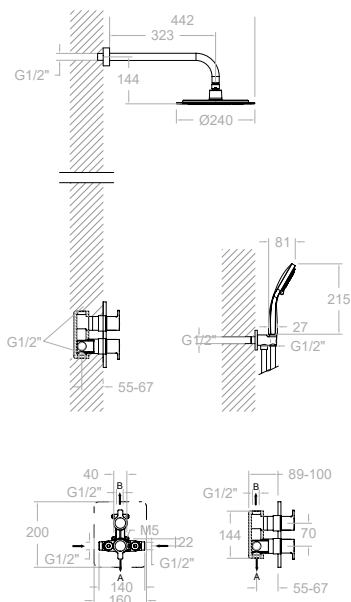
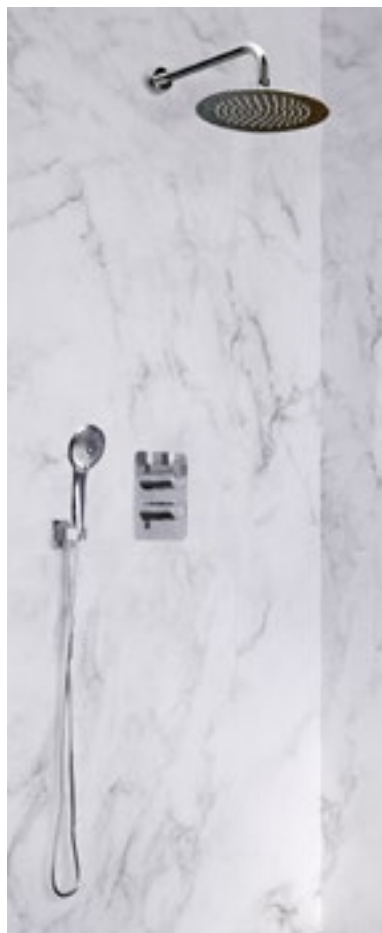

**948712RP240** 420,80 €  
94D302547  
948712S-BHRP240+2876BT+3796+2471C



**948712RP240NM** 631,10 €  
94D303671  
948712SNM-BHRP240NM+2876BTNM+3796NM+2475CNM

Conjunto termostático empotrado 2 vías con soporte más toma de agua, teleducha y rociador mural ABS Ø 240 mm.  
Thermostatic single lever 2 way concealed with support plus water intake, handshower and ABS shower head Ø 240 mm.

**948712RM250** 544,40 €  
94D302551  
948712S-BHRM250+2876BT+3796+2471C

Conjunto termostático empotrado 2 vías con soporte más toma de agua, teleducha ABS y rociador mural metálico Ø 250 mm.  
Thermostatic single lever 2 way concealed with support plus water intake, abs handshower and metallic shower head Ø 250 mm.

**942411S** 170,30 €  
94D302545  
XX2411-KTX1+945000+945100

Termostático de ducha empotrado 1 vía con placa metálica.  
Thermostatic concealed mixer 1 way with ultraslim metallic plate.

**948712S** 233,20 €  
94D302546  
XX8712-KTX2+945000+945100

**948712SNM** 349,80 €  
94D303683  
XX8712NM-KTX2NM+945000NM+945100NM

Empotrado monomando 2 vías.  
Single lever 2 way concealed.

XX8712S	1bar	3bar	5bar
A l/min	14	24	30
B l/min	13	22	28

Kit de ampliación - Extension set: KAIV

Cartucho Cartridge: 1703T + 4000

**BX948712RP240** 2.040,20 €  
94G302548

**BX948712RP240NM** 3.060,70 €  
94G303672

**BX948712RM250** 2.640,30 €  
94G302552

BOX PALET, 5 unidades -3% Descuento especial incorporado.  
BOX PALET, 5 units - 3% Special discount in the price.



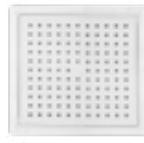
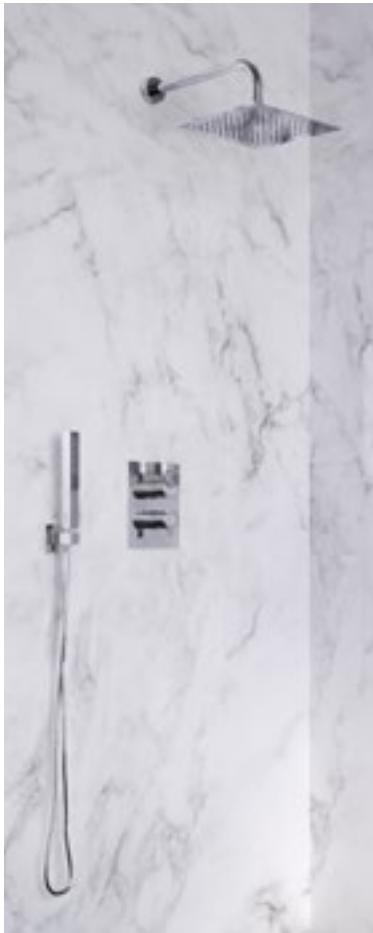

RPK225



RK250



948712RPK225

445,40 €

94D302549

948712KS+RPK225+B350+4716PR+4796+2471C

Conjunto termostático empotrado 2 vías con soporte más toma de agua, teleducha y rociador mural ABS cuadrado 225x225.

Thermostatic single lever 2 way concealed with support plus water intake, hand shower and square ABS shower head.



948712RK250

580,20 €

94D302553

948712KS+RK250+B350+4716PR+4796+2471C

Rociador de metal 250x250 mm.

Headshower accessories 250x250 mm.

948712KS

245,70 €

94D302915

XX8712+KT2+945000+945100

Empotrado monomando 2 vías.

Single lever 2 way concealed.

XX8712S	1bar	3bar	5bar
A l/min	14	24	30
B l/min	13	22	28

Kit de ampliación - Extension set: KATV

Cartucho Cartridge: 1703T + 4000

BX948712RPK225

2.160,20 €

94G302550

BOX PALET, 6 unidades -3% Descuento especial incorporado.

BOX PALET, 6 units - 3% Special discount in the price.

BX948712RK250

2.814,00 €

94G302555

BOX PALET, 6 unidades -3% Descuento especial incorporado.

BOX PALET, 6 units - 3% Special discount in the price.

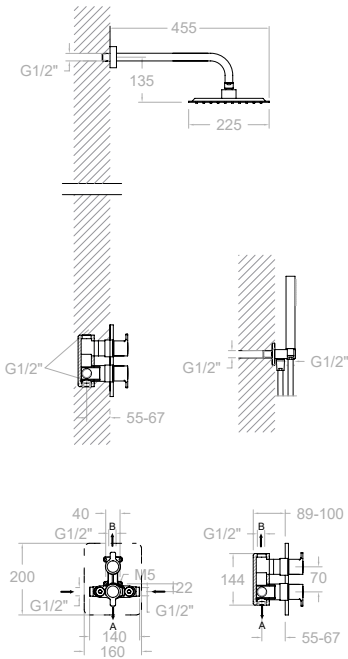

# RS Smart

Colección Collection

**N** New



## Características Técnicas

- Montura cerámica de 1/2".
- Cartucho termostático con Sistema Hot Block de seguridad antiquemaduras y Sistema Termostop de bloqueo de la temperatura a 38°C.
- Caudal a 3 bar: Ducha (de 12 a 16 l/min) y Baño (>20 l/min).
- Nivel acústico a 3 bar < 20 dB.
- Cromado latón: 15 micras de espesor de níquel, 0,3 micras de cromo.
- Presión de uso entre 1-5 bar, recomendada 3 bar. Resiste presiones estáticas ≤ 10 bar y golpes de ariete de 25 bar.
- Temperatura recomendada de agua caliente 55°C. Temperatura máxima de uso 65°C. Máximo 1h a 90°C.
- Resistente al choque térmico y químico anti-legionela.

## Technical Characteristics

- Ceramic 1/2" head.
- Thermostatic cartridge with Hot Block anti-burn system and Termostop temperature blocking system to 38°C.
- Flow rate at 3 bars: Shower (12 to 16 l/min.) and Bath (>20/min.).
- Acoustic level at 3 bars: < 20 dB.
- Chrome-plated brass: 15 microns thick of nickel, 0.3 microns of chrome.
- Working pressure between 1-5 bars, recommended: 3 bars. It resists static pressures ≤ 10 bars and water hammers of 25 bars.
- Recommended temperature for the hot water: 55°C. Maximum working temperature: 65°C. Maximum: 1h at 90°C.
- Resistant to thermal and anti-Legionella chemical shocks.

## Colores disponibles Available colours



**Cromo**  
Chrome



**Negro mate**  
Black matte



**Níquel cepillado**  
Brushed nickel



**Oro cepillado**  
Brushed gold



## RS Smart

### Rs Smart

#### La ducha inteligente

RS Smart es un empotrado termostático de 2 y 3 vías inteligente, capaz de funcionar al mismo tiempo con diferentes salidas de agua y con regulación de caudal individual para cada salida de agua, de esta manera, RS Smart se adapta a las necesidades del usuario en cada momento.

Con RS Smart se consigue una ducha perfecta: selección de temperatura, selección de la salida de agua y selección de intensidad del agua mediante el caudal, todo ello mediante unos botones con doble función creados en Ramon Soler.

El diseño minimalista permite combinar RS Smart con toda la gama de productos de Ramon Soler, especialmente los de hidroterapia con grandes rociadores y también permite ahorrar espacio en el baño. Se presenta en los acabados cromo y negro mate y PVD de oro cepillado, níquel cepillado.

#### The intelligent shower

RS Smart is an intelligent 2 ways and 3 ways concealed thermostatic mixer, capable of operating at the same time with different water outlets and with individual flow regulation for each water outlet. In this way, RS Smart adapts to the needs of the user in every moment.

RS Smart is the perfect shower: temperature selection, water outlet selection and water intensity selection through the flow rate, all through dual-function buttons created by Ramon Soler.

The minimalist design allows RS Smart to be combined with the entire range of Ramon Soler products, especially those for hydrotherapy with large shower heads, and also saves space in the bathroom. It comes in chrome and matt black finishings and PVD finishings in brushed gold & brushed nickel.

#### Ventajas RS Smart Advantages of RS Smart

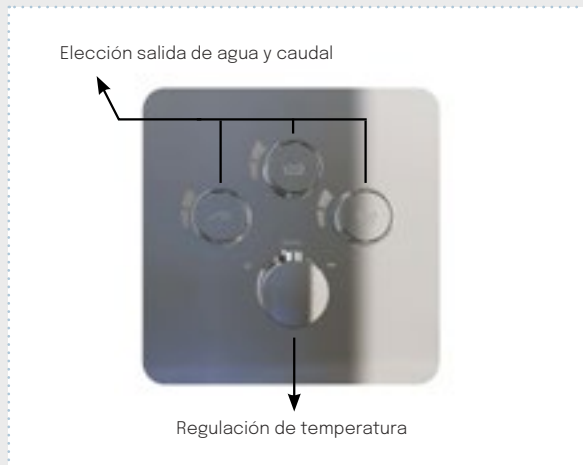

Símbolos para diferentes vías intercambiables.  
Symbols for different water outlets provided in each item.

#### Control inteligente mediante: Intelligent control through:

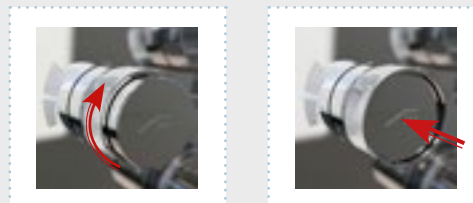

- Botones de doble función: Bóton pulsador para abrir y cerrar la salida de agua y giratorio para regulación de caudal.
- Dual function buttons: Push button to open and close the water outlet and rotary button to regulate the flow.
- Volante para la regulación de la temperatura.
- Handle for temperature's regulation.
- Se puede seleccionar varias salidas de aguas simultáneas.
- Simultaneous water outlets' selection at the same time.

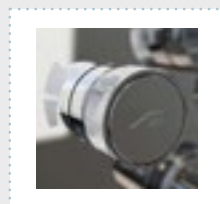

Diseño de los botones con estriado especial ergonómico.  
Ergonomic button through its special design.

RS Smart

Rs Smart

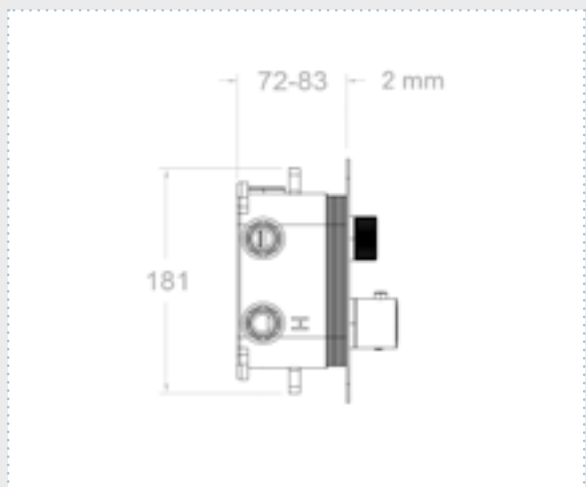

Box completamente estanco y evita filtraciones de agua en el interior de la pared. Puede ser instalada en cualquier tipo de pared, por ejemplo, pladur o standard.

Box completely watertight and prevents water leaks inside the wall. It can be installed on any type of wall, for example plasterboard or standard.

Fácil instalación mediante box con profundidad mínima de 72 mm y ahorro de espacio en el baño mediante placa metálica superslim de espesor 2mm y dimensión del volante máxima de 50 mm.

Easy installation by means of a box with a minimum depth of 72 mm and saving space in the bathroom by means of a super slim metal plate with a thickness of 2 mm and a maximum dimension of the handle of 50 mm.

#### Cartucho termostático de alta precisión.

High precision thermostatic cartridge.

**Fácil mantenimiento: permite el cambio del cartucho o de los botones pulsadores sin tener que desinstalar el grifo.**

Easy maintenance: allows the change of the cartridge or the push buttons without having to uninstall the mixer.



Oro cepillado (PVD)  
Brushed gold (PVD)



Negro mate  
Black matte



Níquel cepillado  
Brushed nickel





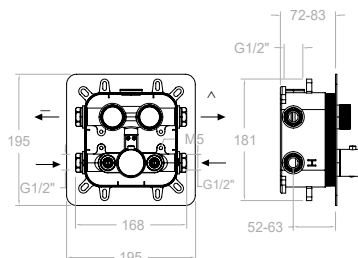

\*Caja incluida.  
Box included.

**85T201S**  
85D307806

618,50 €

Conjunto termostático empotrado 2 vías, sistema selección push con control de caudal.

2 ways concealed thermostatic shower set, push selection system with flow control.



## 2 Vías/Ways

Acabados especiales disponibles en Julio  
Special finishings available in July



**85T201SNM**  
85D308096

927,75 €

**85T201SNC**  
85D308100

1.082,38 €

**85T201SOC**  
85D308098

1.082,38 €

Conjunto termostático empotrado 2 vías, sistema selección push con control de caudal.

2 ways concealed thermostatic shower set, push selection system with flow control.

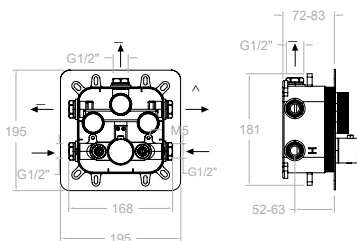

**85T301S**  
85D307808

693,20 €

Conjunto termostático empotrado 3 vías, sistema selección push con control de caudal.

3 ways concealed thermostatic shower set, push selection system with flow control.



## 3 Vías/Ways

Acabados especiales disponibles en Julio  
Special finishings available in July



**85T301SNM**  
85D308097

1.039,80 €

**85T301SNC**  
85D308101

1.213,10 €

**85T301SOC**  
85D308099

1.213,10 €

Conjunto termostático empotrado 2 vías, sistema selección push con control de caudal.

2 ways concealed thermostatic shower set, push selection system with flow control.

# Hidroterapia

## Hydrotherapy

ramonsoler.



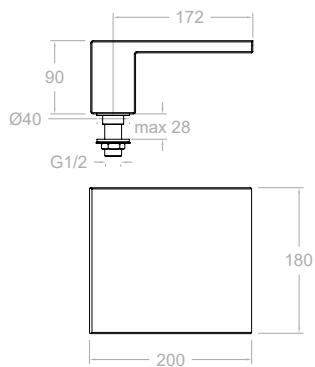

**CR01**  
99Z302617

762,60 €

Caño cuadrado cascada repisa bañera.  
Square spout waterfall mounted bathtub.

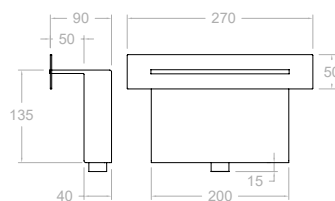
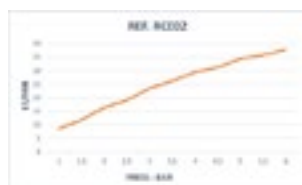

**RCE02**  
99Z300701

802,30 €

Rociador de cascada empotrado.  
Waterfall concealed wall shower.





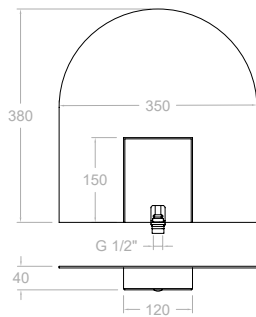
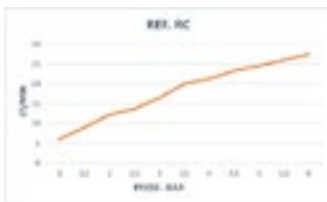

**RC**

99Z300698

489,60 €



Rociador de pared con cascada.  
Waterfall wall mounted shower.



**RCEXT**

99Z303345

695,50 €

Rociador de cascada empotrado. Para exterior. Acabado cepillado mate.  
Waterfall wall mounted shower. Outdoor. Finished brushed matte.

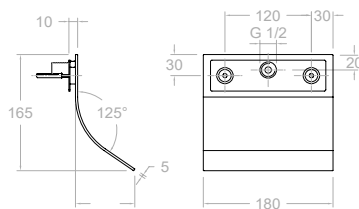

**169**

99Z300699

475,80 €



Caño de cascada para lavabo empotrado.  
Waterfall wall mounted basin.



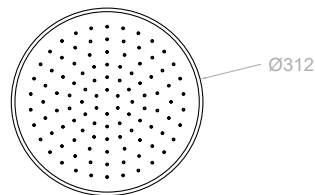
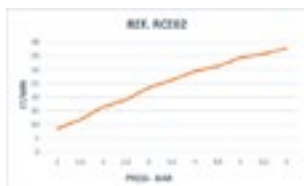
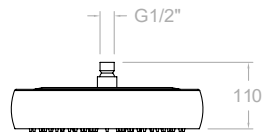

<b>RMVOL</b> 99Z302616	780,40 €	●
<b>RMVOLNM</b> 99Z305271	1.391,20 €	●
<b>RMVOLNC</b> 99Z305270	1.391,20 €	●

Rociador redondo volumétrico.  
Volumetric round showerhead.

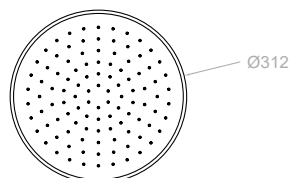
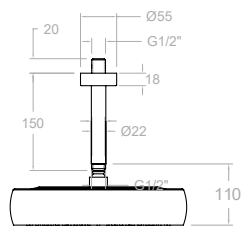

<b>BVRMVOL</b> 99H302746 RMVOL + BV15	815,10 €	●
<b>BVRMVOLNM</b> 99H305054 RMVOLNM + BV15NM	1.454,10 €	●
<b>BVRMVOLNC</b> 99H305053 RMVOLNC + BV15NC	1.454,10 €	●

Rociador redondo volumétrico de techo.  
Ceiling mounted shower arm with volumetric round showerhead.





<b>BHRMVOL</b> 99H302745 RMVOL + B350	833,60 €	<input type="radio"/>
<b>BHRMVOLNM</b> 99H305286 RMVOLNM + B350NM	1.486,80 €	<input checked="" type="radio"/>
<b>BHRMVOLNC</b> 99H305284 RMVOLNC + B350NC	1.486,80 €	<input type="radio"/>



Rociador redondo volumétrico de pared.  
Wall mounted shower arm with volumetric round showerhead.



<b>RB200</b> 99Z300704	632,20 €	<input type="radio"/>	<b>RB300</b> 99Z300705	814,50 €	<input type="radio"/>
<b>RB200NM</b> 99Z305083	1.126,80 €	<input checked="" type="radio"/>	<b>RB300NM</b> 99Z305086	1.451,60 €	<input checked="" type="radio"/>
<b>RB200NC</b> 99Z305082	1.126,80 €	<input type="radio"/>	<b>RB300NC</b> 99Z305085	1.451,60 €	<input type="radio"/>



Rociador redondo Ø 200 mm.  
Round showerhead Ø 200 mm.

Rociador redondo Ø 300 mm.  
Round showerhead Ø 300 mm.

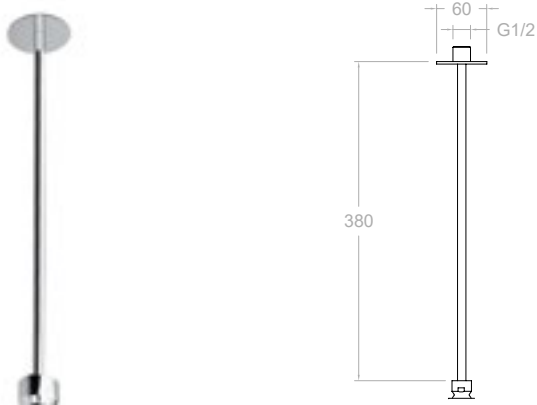

<b>BV400</b> 99Z300752	238,00 €	<input type="radio"/>
<b>BV400NM</b> 99Z305076	424,30 €	<input checked="" type="radio"/>
<b>BV400NC</b> 99Z305075	424,30 €	<input type="radio"/>



Brazo cenital de ducha.  
Shower arm vertical.

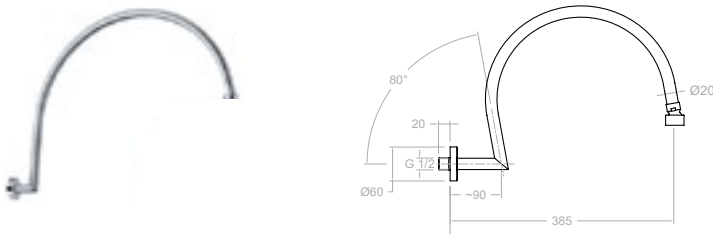

<b>BA390</b> 99Z300750	243,30 €	<input type="radio"/>
<b>BA390NM</b> 99Z305070	433,90 €	<input checked="" type="radio"/>
<b>BA390NC</b> 99Z305069	433,90 €	<input type="radio"/>



Brazo mural de ducha.  
Wall shower arm.

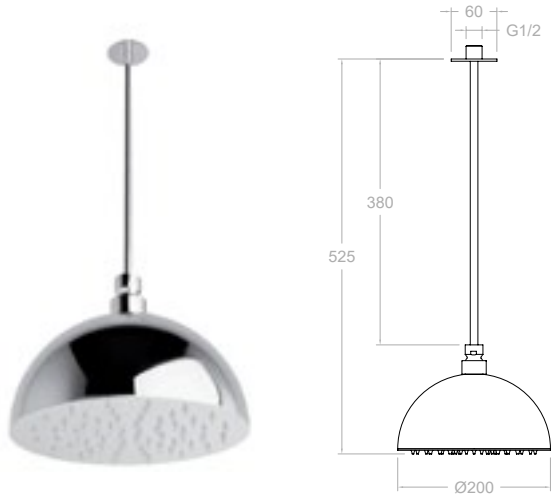

<b>RB2V400</b> 99H300753 RB200-BV400	870,20 €	●
<b>RB2V400NM</b> 99H305060 RB200NM + BV400NM	1.551,10 €	●
<b>RB2V400NC</b> 99H305059 RB200NC + BV400NC	1.551,10 €	●

Rociador redondo Ø 200 mm con brazo cenital.  
Ceiling shower arm with head shower Ø 200 mm.

<b>RB3V400</b> 99H300754 RB300-BV400	1.052,50 €	●
<b>RB3V400NM</b> 99H305067 RB300NM + BV400NM	1.875,80 €	●
<b>RB3V400NC</b> 99H305066 RB300NC + BV400NC	1.875,80 €	●

Rociador redondo Ø 300 mm con brazo cenital.  
Ceiling shower arm with head shower Ø 300 mm.

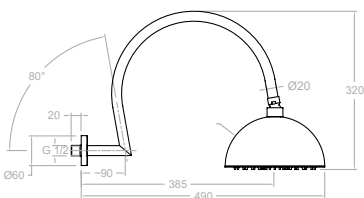

<b>RB2A390</b> 99H300748 RB200-BA390	875,50 €	●
<b>RB2A390NM</b> 99H305057 RB200NM + BA390NM	1.560,80 €	●
<b>RB2A390NC</b> 99H305056 RB200NC + BA390NC	1.560,80 €	●

Rociador redondo Ø 200 mm con brazo mural.  
Wall shower arm with head shower Ø 200 mm.

<b>RB3A390</b> 99H300749 RB300-BA390	1.057,80 €	●
<b>RB3A390NM</b> 99H305064 RB300NM + BA390NM	1.885,50 €	●
<b>RB3A390NC</b> 99H305063 RB300NC + BA390NC	1.885,50 €	●

Rociador redondo Ø 300 mm con brazo mural.  
Wall shower arm with head shower Ø 300 mm.

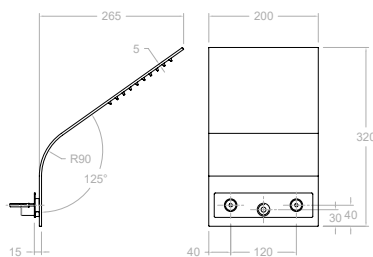

<b>RIKS</b> 99Z300707	911,00 €	●
--------------------------	----------	---

Rociador de pared inclinado.  
Head shower wall mounted.

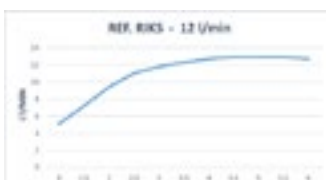

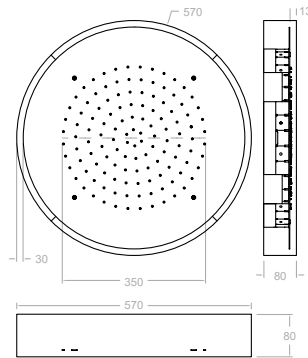

**RELED570**  
99Z302619

6.323,40 €

Rociador redondo Ø570 empotrado de techo con lluvia y cromoterapia.  
Round Head Shower Ø570 built-in ceiling with rain and chromotherapy.

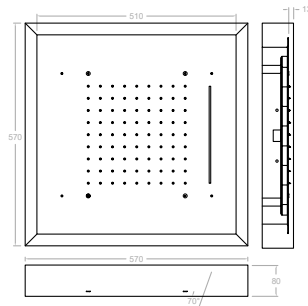
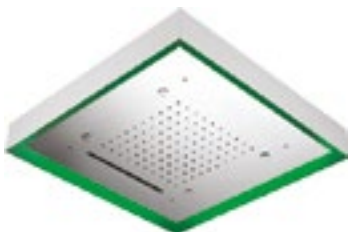

**REKLEDNC570**  
99Z302618

6.323,40 €

Rociador cuadrado 570x570 empotrado de techo con lluvia, cromoterapia, cascada y nebulizador.  
Round Head Shower Ø570 built-in ceiling with rain with mist effect, waterfall and chromotherapy.



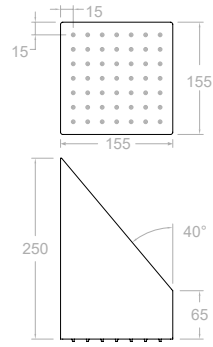
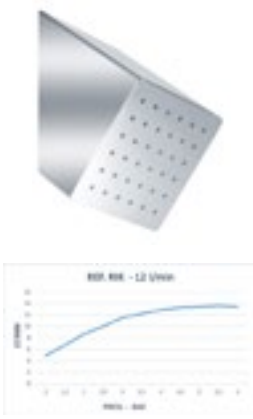

**RIK** 99Z300703 740,80 €

Rociador de pared cuadrado.  
Square shower head wall mounted.

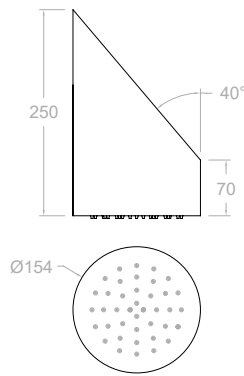
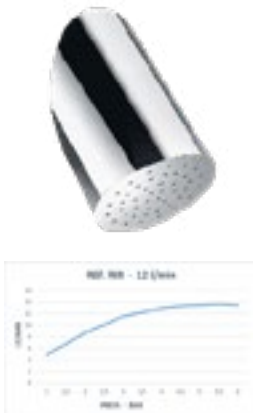

**RIR** 99Z300702 673,00 €

**RIRNM** 99Z305095 1.199,50 €

**RIRNC** 99Z305094 1.199,50 €

Rociador de pared redondo.  
Round shower head wall mounted.

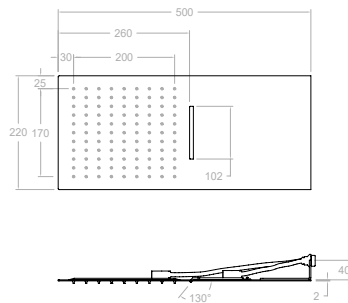
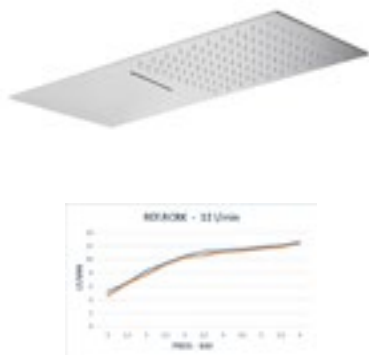

**RCRK** 99Z300708 1.044,30 €

Rociador de pared efecto lluvia y cascada.  
Wall mounted rainshower and waterfall effect showerhead.

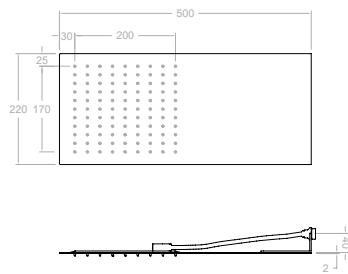

**RRK** 99Z300709 791,20 €

**RRKNNM** 99Z305100 1.410,40 €

Rociador de pared efecto lluvia.  
Wall mounted rainshower and effect showerhead.





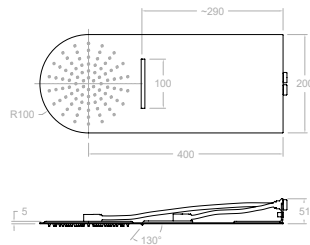
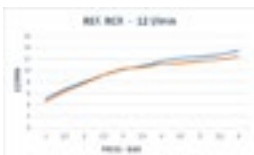

**RCR**  
99Z300710

978,90 €



**Rociador de pared efecto lluvia y cascada.**  
Wall mounted rainshower and waterfall effect showerhead.

Caudal Flow: 3 bar / 5l/min

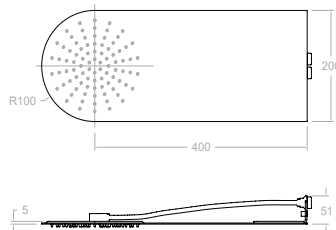

**RR**  
99Z300711

746,40 €



**RRNM**  
99Z305103

1.330,50 €

**Rociador de pared efecto lluvia.**  
Wall mounted rainshower and effect showerhead.



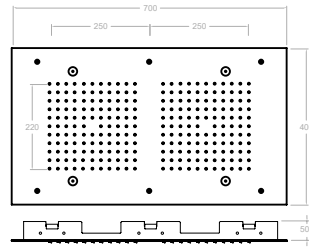

**RELNRK**  
99Z300718

1.740,20 €

Rociador rectangular empotrado con efecto lluvia y nebulizador.  
Concealed ceiling rectangular showerhead with mist effect.

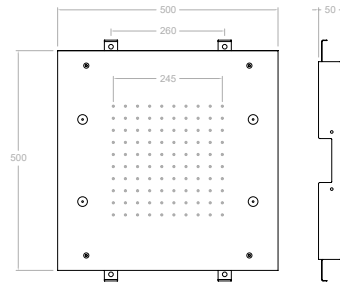

**RELNK500**  
99Z300715

1.291,60 €

Rociador cuadrado empotrado. 500 mm. con lluvia y nebulizador.  
Square concealed ceiling mounted shower head and mist effect.

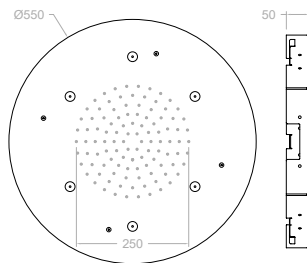
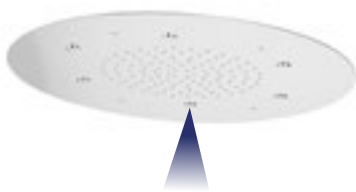
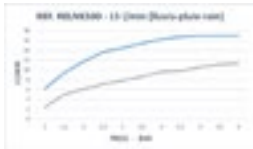

**RELN550**  
99Z300722

1.237,00 €

Rociador redondo empotrado. Con efecto lluvia y nebulizador. Ø 550 mm.  
Concealed ceiling round showerhead with rainshower and mist effect. Ø 550 mm.

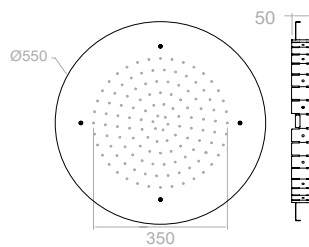
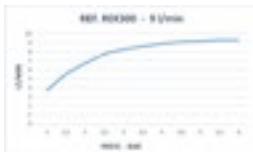

**RE550**  
99Z300721

944,90 €

**RE550NM**  
99Z305090

1.684,30 €

**RE550NC**  
99Z305088

1.684,30 €

Rociador redondo empotrado Ø 550 mm.  
Concealed ceiling round showerhead Ø 550 mm.



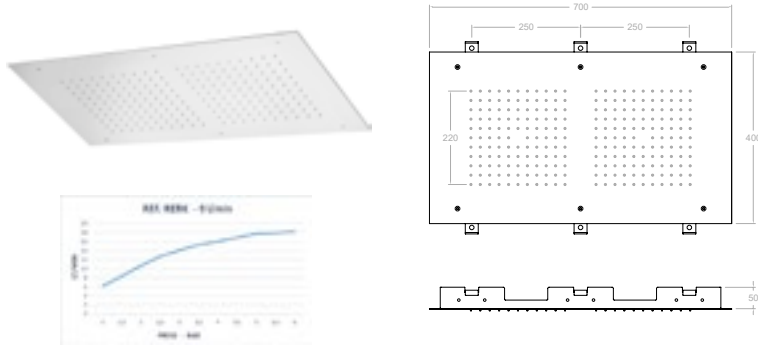

**RERK**  
99Z300717 **1.482,00 €**

Rociador rectangular empotrado.  
Concealed ceiling rectangular showerhead.

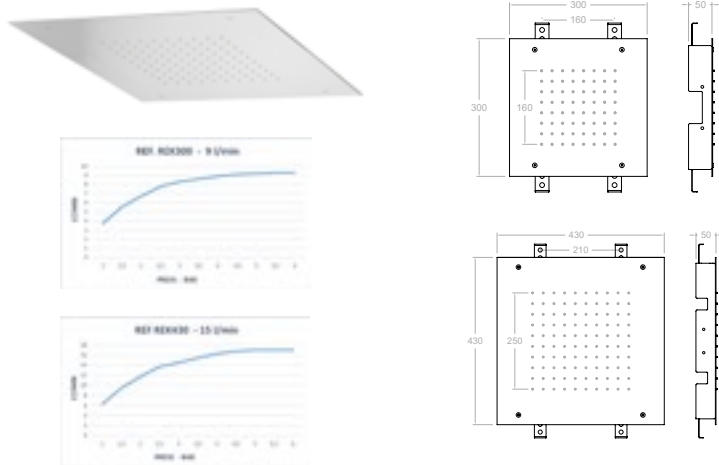

**REK300**  
99Z300712 **673,00 €**

Rociador cuadrado empotrado. 300 mm.  
Concealed ceiling square showerhead 300 mm.



**REK430**  
99Z300713 **895,90 €**

Rociador cuadrado empotrado. 430 mm.  
Concealed ceiling square showerhead 430 mm.

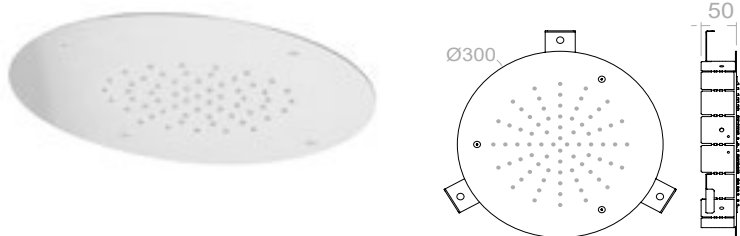

**RE300**  
99Z300720 **707,00 €**

Rociador redondo empotrado. Ø 300 mm.  
Concealed ceiling round showerhead Ø 300 mm.

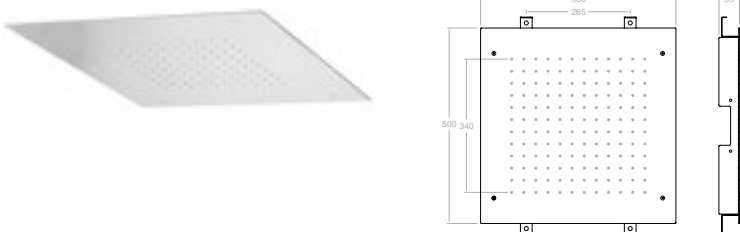

**REK500**  
99Z300714 **1.033,20 €**

**REK500NM**  
99Z302132 **1.841,50 €**

**REK500NC**  
99Z305092 **1.841,50 €**

Rociador cuadrado empotrado 500 mm.  
Concealed ceiling square showerhead 500 mm.





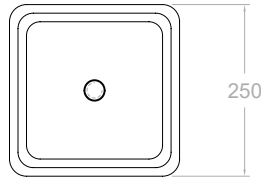

**RK250** 204,10 €  
255543

**RK250NM** 367,60 €  
99Z305261

**RK250NC** 367,60 €  
99Z305259

**RK250OC** 367,60 €  
99Z305262

Rociador cuadrado 250 mm.  
Square showerhead 250 mm.

bar	Caudal l/min
3	10

**RK300N** 280,50 €  
255552

**RK300NM** 504,70 €  
99Z305263

**RK300NC** 504,70 €  
99Z305264

**RK300OC** 504,70 €  
99Z305265

Rociador cuadrado 300 mm.  
Square showerhead 300 mm.

bar	Caudal l/min
3	15

**RK400** 403,50 €  
255561

Rociador cuadrado 400 mm.  
Square showerhead 400 mm.

bar	Caudal l/min
3	15

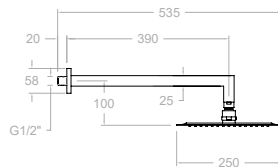

**BHRK250** 313,80 €  
256299  
RK250 + BK350

**BHRK250NM** 559,60 €  
99H305243  
RK250NM + BK350NM

**BHRK250NC** 559,60 €  
99H305242  
RK250NC + BK350NC

**BHRK250OC** 559,60 €  
99H305244  
RK250OC + BK350OC

Brazo de pared para salida ducha  
con rociador cuadrado cuadrado:  
250 mm.  
Wall mounted bracket for square  
showerhead 250 mm.

**BHRK300** 390,20 €  
233511  
RK300N + BK350

**BHRK300NM** 696,70 €  
99H305245  
RK300NM + BK350NM

**BHRK300NC** 696,70 €  
99H305246  
RK300NC + BK350NC

**BHRK300OC** 696,70 €  
99H305247  
RK300OC + BK350OC

Brazo de pared para salida ducha  
con rociador cuadrado cuadrado:  
300 mm.  
Wall mounted bracket for square  
showerhead 300 mm.

**BHRK400** 513,10 €  
233520  
RK400 + BK350

Brazo de pared para salida ducha con rociador cuadrado cuadrado: 400 mm.  
Wall mounted bracket for square showerhead 400 mm.



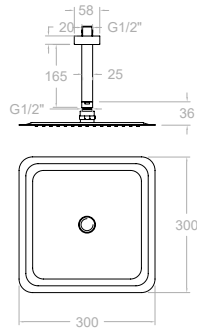

- BVKRK250** 240,70 €  
99H305384  
RK250 + BVK15
- BVKRK250NM** 432,60 €  
99H305279  
RK250NM + BVK15NM
- BVKRK250NC** 432,60 €  
99H305277  
RK250NC + BVK15NC
- BVKRK250OC** 432,60 €  
99H305280  
RK250OC + BVK15OC

Brazo salida ducha con rociador cuadrado: 250 mm.  
Ceiling mounted bracket for square showerhead 250mm.

- BVKRK300** 317,00 €  
99H305385  
RK300N + BVK15
- BVKRK300NM** 569,80 €  
99H305282  
RK300NM + BVK15NM
- BVKRK300NC** 569,80 €  
99H305281  
RK300NC + BVK15NC
- BVKRK300OC** 569,80 €  
99H305283  
RK300OC + BVK15OC

Brazo salida ducha con rociador cuadrado: 300 mm.  
Ceiling mounted bracket for square showerhead 300mm.



- BVKRK400** 440,00 €  
99H305387  
RK400 + BVK15

Brazo salida ducha con rociador cuadrado: 400 mm.  
Ceiling mounted bracket for square showerhead 400mm.

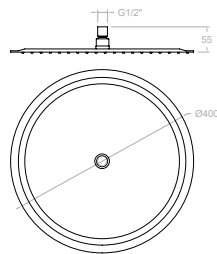

- RM250** 178,60 €  
255516
- RM250NM** 321,30 €  
99Z302136
- RM250NC** 321,30 €  
99Z302345
- RM250OC** 321,30 €  
99Z302162

Rociador redondo.  
Round showerhead.

bar	Caudal l/min
3	10

- RM300** 235,70 €  
255525
- RM300NM** 424,30 €  
99Z305267
- RM300NC** 424,30 €  
99Z305266
- RM300OC** 424,30 €  
99Z305268
- RM300CUC** 424,30 €  
99Z305268

Rociador redondo.  
Round showerhead.

bar	Caudal l/min
3	10

- RM400** 386,60 €  
255534

Rociador redondo.  
Round showerhead.

bar	Caudal l/min
3	15



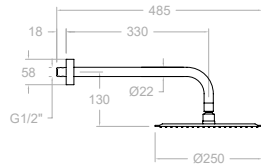

**BHRM250** 231,60 €  
256245  
RM250 + B350

**BHRM250NM** 416,80 €  
99D302884  
RM250NM + B350NM

**BHRM250NC** 416,80 €  
99D302886  
RM250NC + B350NC

**BHRM250OC** 416,80 €  
99D302885  
RM250OC + B350OC

Brazo de pared para salida ducha con rociador: Ø250.  
Wall mounted bracket for showerhead: Ø 250.

**BHRM300** 288,70 €  
256227  
RM300 + B350

**BHRM300NM** 519,80 €  
99H305257  
RM300NM + B350NM

**BHRM300NC** 519,80 €  
99H305256  
RM300NC + B350NC

**BHRM300OC** 519,80 €  
99H305255  
RM300OC + B350OC

Brazo de pared para salida ducha con rociador: Ø 300.  
Wall mounted bracket for showerhead: Ø 300.



**BHRM400** 439,70 €  
256254  
RM400 + B350

Brazo de pared para salida ducha con rociador: Ø 400.  
Wall mounted bracket for showerhead: Ø 400.

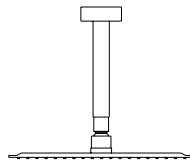

**BVRM250** 213,20 €  
256200  
RM250 + BV15

**BVRM250NM** 384,10 €  
99H305248  
RM250NM + BV15NM

**BVRM250NC** 384,10 €  
99H305249  
RM250NC + BV15NC

**BVRM250OC** 384,10 €  
99H305250  
RM250OC + BV15OC

Brazo de techo para salida ducha con rociador: Ø 250.  
Ceiling mounted bracket for showerhead: Ø 250.

**BVRK300** 390,20 €  
233511  
RK300N + BK350

**BVRK300NM** 696,70 €  
99H305245  
RK300NM + BK350NM

**BVRK300NC** 696,70 €  
99H305246  
RK300NC + BK350NC

**BVRK300OC** 696,70 €  
99H305247  
RK300OC + BK350OC

Brazo de techo para salida ducha con rociador: Ø 300.  
Ceiling mounted bracket for showerhead: Ø 300.



**BVRM400** 421,30 €  
256218  
RM400 + BV15

Brazo de techo para salida ducha con rociador: Ø 400.  
Ceiling mounted bracket for showerhead: Ø 400.



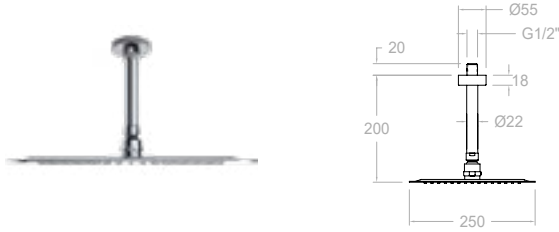

**BVRK250** 256308 238,90 €  
 RK250 + BV15

Brazo salida ducha con rociador cuadrado: 250 mm.  
 Ceiling mounted bracket for square showerhead 250mm.



**BVRK300** 233547 315,20 €  
 RK300N + BV15

Brazo salida ducha con rociador cuadrado: 300 mm.  
 Ceiling mounted bracket for square showerhead 300mm.

**BVRK400** 233556 438,20 €  
 RK400 + BV15

Brazo salida ducha con rociador cuadrado: 400 mm.  
 Ceiling mounted bracket for square showerhead 400mm.

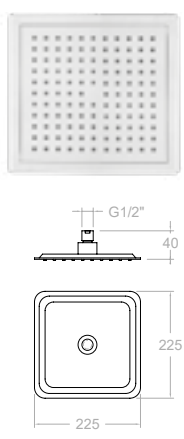

**RPK225** 255570 64,80 €

**RPK225NM** 99Z305097 99,10 €

Rociador cuadrado 225 mm ABS.  
 Square ABS showerhead 225mm.

bar	Caudal l/min
3	18



**BHRPK225** 256281 174,50 €  
 RPK225 + BK350

**BHRPK225NM** 99H305364 296,50 €  
 RPK225NM + BK350NM

Brazo de ducha con rociador: Ø 225 mm.  
 Wall mounted bracket for showerhead Ø 225 mm.



**BNRPK225** 99H301708 117,90 €  
 RPK225 + B350

Rociador cuadrado 225 mm ABS.  
 Square ABS showerhead 225mm.



**BVRPK225** 256290 99,50 €  
 RPK225 + BV15

**BVRPK225NM** 99H305365 161,80 €  
 RPK225NM + BV15NM

Brazo de techo para salida ducha con rociador: Ø 225 mm.  
 Ceiling mounted bracket for showerhead: Ø 225 mm.

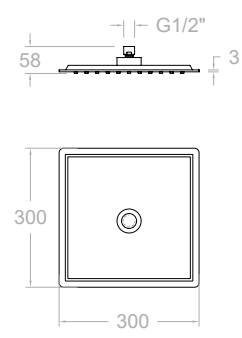

**RPK300** 99Z307373 64,90 €

**RPK300NM** 99Z307374 97,40 €

**RPK300OC** 99Z307376 113,60 €

Rociador cuadrado 300 mm ABS.  
 Square ABS showerhead 300 mm.



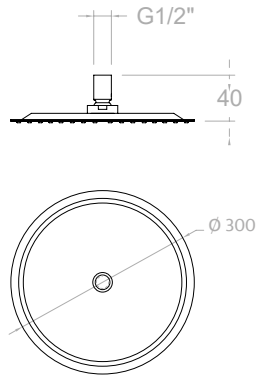

<b>RP300</b> 99Z303028	64,80 €	
<b>RP300NM</b> 99Z303508	113,40 €	
<b>RP300OC</b> 99Z307355	113,40 €	

Rociador ABS redondo 300.  
ABS Round showerhead 300.

bar	Caudal l/min
3	16

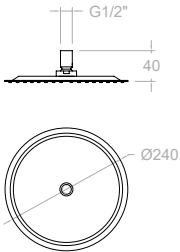

<b>RP240</b> 251322	50,70 €	
<b>RP240NM</b> 99Z303680	77,50 €	

Rociador redondo Ø 240.  
Round showerhead Ø 240.



<b>BHRP240</b> 256263	103,70 €	
RP240 + B350		

<b>BHRP240NM</b> 99Z303681	173,00 €	
RP240NM + B350NM		

Brazo de ducha con rociador: Ø 240.  
Wall mounted bracket for showerhead Ø 240.



<b>BVRP240</b> 256272	85,40 €	
RP240 + BV15		

Brazo de ducha con rociador: Ø 240.  
Ceiling mounted bracket for showerhead Ø 240.

bar	Caudal l/min
3	16

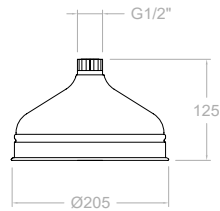

<b>RG200</b> 194352	219,30 €	
------------------------	----------	--

Rociador redondo.  
Round showerhead.

bar	Caudal l/min
3	15



<b>BHRG200</b> 196998	272,30 €	
--------------------------	----------	--

Brazo de pared para salida ducha con rociador: Ø 205.  
Wall mounted bracket for showerhead: Ø 205.

RG200 + B350

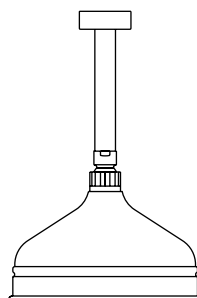

<b>BVRG200</b> 201408	253,90 €	
--------------------------	----------	--

Brazo de techo para salida ducha con rociador: Ø 205.  
Ceiling mounted bracket for showerhead: Ø 205.

RG200 + BV15

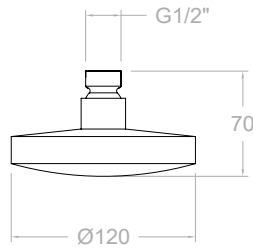

**RP120**  
242070

23,60 €



Rociador redondo.  
Round showerhead.

bar	Caudal l/min
3	16

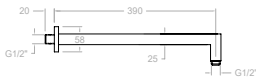

**BK350**  
212163

109,70 €

**BK350NM**  
99Z305073

192,00 €

**BK350NC**  
99Z305072

192,00 €

**BK350OC**  
99Z305074

192,00 €

Brazo de pared 400 mm.  
Shower arm, 400 mm.

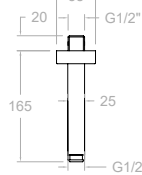

**BVK15**  
99Z305078

36,60 €

**BVK15NM**  
99Z305080

65,10 €

**BVK15NC**  
99Z305079

65,10 €

**BVK15OC**  
99Z305081

65,10 €

Brazo de ducha para techo cuadrado  
165 mm.  
Ceiling shower arm 165 mm.



**4799**  
212100

50,00 €

**479902NM**  
99Z304965

89,70 €

**479902NC**  
99Z304966

89,70 €

**479902OC**  
99Z304967

89,70 €

Codo de salida antiretorno para  
pared.  
Water outlet elbow.



**4796**  
227499

59,30 €

**4798NM**  
99Z302169

107,00 €

**4798NC**  
99Z304962

107,00 €

**4798OC**  
99Z304964

107,00 €

Codo de salida de agua y soporte  
fijo cuadrado, antiretorno.  
Water outlet elbow.

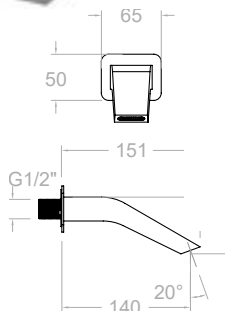

**16702**  
AAZ305153  
CLEU+FCB+MFCB

123,30 €

**16702NM**  
AAZ305155  
CLEUNM+FCBNM+MFCB

222,10 €

**16702NC**  
AAZ305154  
CLEUNC+FCBNC+MFCB

222,10 €

**16702OC**  
AAZ305156  
CLEUOC+FCBOC+MFCB

222,10 €

Caño de pared para bañera.  
Bath Spout.

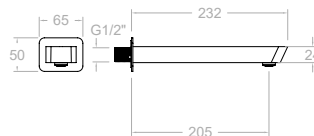

**16602**  
AAZ305148  
CBA+FCB+MFCB

121,10 €

**16602NM**  
AAZ305150  
CBANM+FCBNM+MFCB

217,90 €

**16602NC**  
AAZ305149  
CBANC+FCBNC+MFCB

217,90 €

**16602OC**  
AAZ305151  
CBAOC+FCBOC+MFCB

217,90 €

Caño fundido bañera mural.  
Spout without diverter..



**B350** 53,00 €  
197007

**B350NM** 95,60 €  
99Z302140

**B350NC** 95,60 €  
99Z302339

**B350OC** 95,60 €  
99Z302340

**B350CUC** 95,60 €  
99Z307680

Brazo de pared 350 mm.  
Shower arm. 350 mm.



**720** 27,20 €  
156146

Brazo de ducha 165 mm.  
Shower arm 165 mm.



**710** 16,90 €  
500684

Brazo de ducha 102 mm.  
Shower arm 102 mm.

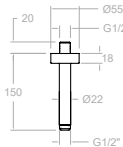

**BV15** 34,70 €  
201255

**BV15NM** 62,70 €  
99Z302139

**BV15NC** 62,70 €  
99Z304435

**BV15OC** 62,70 €  
99Z304434

Brazo de ducha para techo 150 mm.  
Ceiling shower arm 150 mm.



**9990ARD** 20,30 €  
192993

**999002NM** 33,70 €  
99Z302135

**999002NC** 33,70 €  
99Z302674

**999002OC** 33,70 €  
99Z302675

Codo de salida de agua con  
antirretorno.  
Water outlet elbow with check valve.

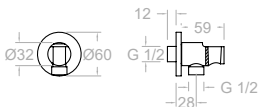

**3796** 47,40 €  
227490

**3796NM** 85,40 €  
99Z302357

**3796NC** 85,40 €  
99Z302356

**3796OC** 85,40 €  
99Z302358

**3796CUC** 85,40 €  
99Z307678

Codo de salida de agua y soporte  
fijo redondo.  
Water outlet elbow.



**9872** 41,60 €  
99Z305370

Ducha lateral cilíndrica.  
Side shower jet



**4772** 49,90 €  
99Z305369

Ducha lateral cuadrada.  
Side Shower jet.



**168** 47,00 €  
227409

Caño fundido Bañera mural 130 mm.  
Spout without diverter 130 mm.

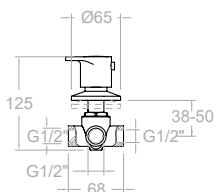

**9437** 157,50 €  
94F305436

**9437NM** 275,60 €  
94F305437

**9437NC** 275,60 €  
94F305439

**9437OC** 275,60 €  
94F305438

Inversor de 3 vías, mural.  
3 way diverter.

Cartucho Cartridge: 1000 I  
Set de ampliación Extension set: KAI3V

**94071/2X1** 94,90 €  
94F305427

**94071/2X1NM** 166,00 €  
94F305429

**94071/2X1NC** 166,00 €  
94F305432

**94071/2X1OC** 166,00 €  
94F305430

Llave de paso de 1/2".  
1/2" angle valve.

Montura Head: 5000  
Set de ampliación Extension set: KALLP

**94073/4X1** 124,60 €  
94F305428

**94073/4X1NM** 217,90 €  
94F305433

**94073/4X1NC** 217,90 €  
94F305435

**94073/4X1OC** 217,90 €  
94F305434

Llave de paso de 3/4".  
3/4" angle valve.

Montura Head: 6000  
Set de ampliación Extension set: KALLP

Kuatro

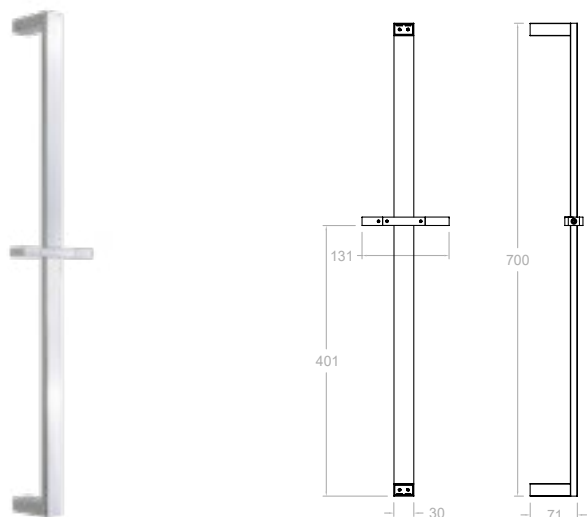

<b>477302S</b> 99Z302192	113,40 €	
<b>477302SNM</b> 99Z304953	199,40 €	
<b>477302SNC</b> 99Z304954	199,40 €	
<b>477302SOC</b> 99Z304955	199,40 €	

Barra de ducha cuadrada 70 cm. sin accesorios.  
Shower bar without accessories.



<b>477302K3</b> 99H302611 477302S+4913K3+2471C	174,80 €	
--	----------	--

Barra de ducha con accesorios K3.  
Shower bar with accessories K3.



<b>477302K1</b> 99H302610 477302S+4912K1+2471C	167,20 €	
--	----------	--

Barra de ducha con accesorios K1.  
Shower bar with accessories K1.



<b>477302MR</b> 99H305015 477302S+4716MR+2471C	176,40 €	
--	----------	--

<b>477302MRNM</b> 99H304959 477302SNM+4716MRNM+2475CNM	312,60 €	
--	----------	--

<b>477302MRNC</b> 99H304960 477302SNC+4716MRNC+2475CNC	312,60 €	
--	----------	--

<b>477302MROC</b> 99H304961 477302SOC+4716MROC+2475COC	312,60 €	
--	----------	--

Barra de ducha cuadrada 70 cm. con accesorios MR.  
Shower bar with accessories MR.



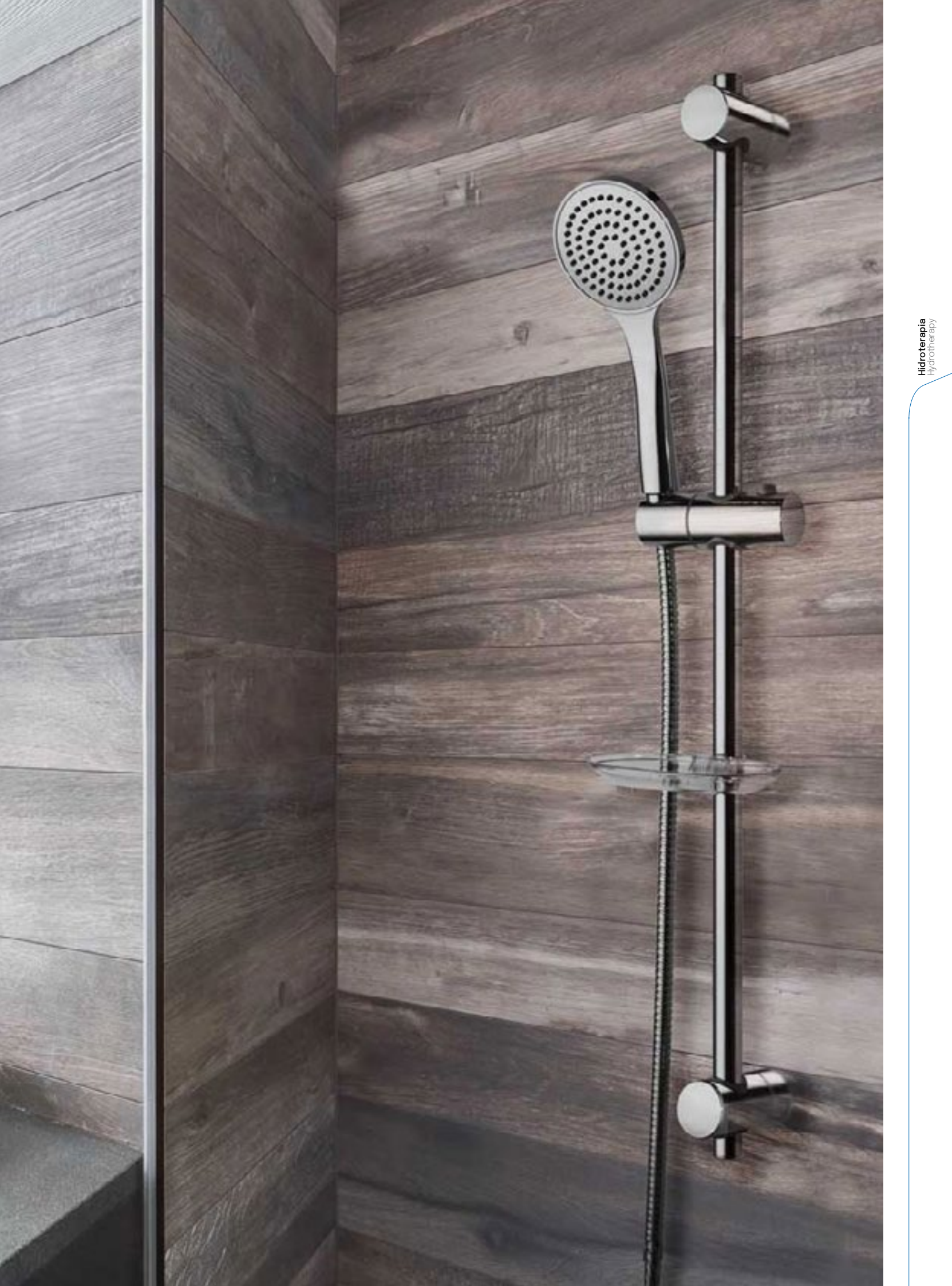



Alexia

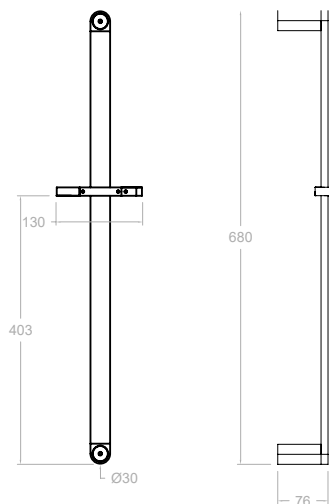

<b>776001S</b> 99Z302193	119,20 €	
<b>776001SNM</b> 99Z302158	214,40 €	
<b>776001SNC</b> 99Z303565	214,40 €	
<b>776001SOC</b> 99Z303547	214,40 €	



Barra de ducha semi redonda 70 cm, sin accesorios.  
Shower bar without accessories.



<b>776001K3</b> 99H302634	180,60 €	
776001S+4913K3+2472C		



Barra de ducha 70 cm, con accesorios K3, 3 funciones.  
Shower bar with accessories K3.



<b>776001MO</b> 99H304971	182,20 €	
776001S+3713M+2471C		



Barra de ducha 70 cm, con accesorios MO.  
Shower bar with accessories MO.

<b>776001DNM</b> 99H304968	327,80 €	
776001SNM+3714NM+2475CNM		

<b>776001DNC</b> 99H304969	327,80 €	
776001SNC+3714NC+2475CNC		

<b>776001DOC</b> 99H304970	327,80 €	
776001SOC+3714OC+2475COC		

Barra de ducha 70 cm, con accesorios D.  
Shower bar with accessories D.

Zenit

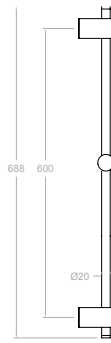

T1



T3



TR



MO



**7750S**  
227436

115,80 €



Barra de ducha de latón , soporte deslizante ABS, sin accesorios.  
Shower bar without accessories.

**7750T1**  
300133

160,40 €

**7750T3**  
256542

166,60 €

**7750TR**  
99H301347

172,80 €

**7750MO**  
256551

178,80 €

Barra de ducha con accesorios.  
Shower bar with accessories.

Universal

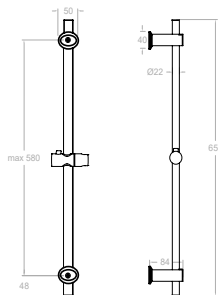

VP



T1



BT



**778002S**  
99Z307769

39,90 €



**778002SNM**  
99Z307770

59,90 €

Barra de ducha sin accesorios, con soportes de fijacion pared adaptables.  
Shower bar without accessories with wall fixation adaptable supports.

**778002VP**  
99H307776

52,40 €

Barra de ducha con accesorios.  
Shower bar with accessories.

**778002T1**  
99H307820

75,90 €

Barra de ducha con accesorios.  
Shower bar with accessories.

**778002BT**  
99H307774

77,90 €

**778002BTNM**  
99H307775

116,90 €

Barra de ducha con accesorios.  
Shower bar with accessories.



Odisea

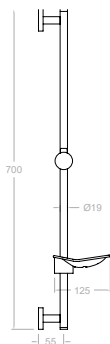

T1

T3

AS

MO



**377302S**

99Z301883

43,80 €



Barra de ducha sin accesorios.  
Shower bar without accessories.

**377302T1**

99H304944

88,40 €

**377302T3**

99H301887

94,60 €

**377302AS**

99H301884

101,90 €

**377302MO**

99H301886

106,80 €

Barra de ducha con accesorios.  
Shower bar with accessories.

Polo

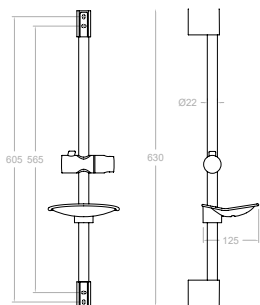

VP2

NL

T1

BT

T3

AS



**982402S**

300179

35,30 €



Barra de ducha sin accesorios.  
Shower bar without accessories.

**982402VP2**

99H306236

47,80 €

**982402NL**

99H306172

69,00 €

**982402T1**

300182

71,30 €

**982402BT**

99H302061

73,20 €

**982402T3**

300183

77,50 €

**982402AS**

300180

84,80 €

Barra de ducha con accesorios.  
Shower bar with accessories.



Gaudí

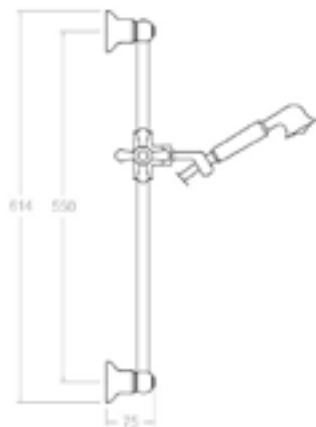

**3086S** 136,80 €  
197016



Barra de ducha sin accesorios.  
Shower bar without accessories.

**3086G** 177,80 €  
197097

Barra de ducha con accesorios.  
Shower bar with accessories.



**T20002RM300**

377,10 €

99H302793

T100D+RD04M+IDP16+SFT24IDP16+1129C+1128C+RM300+3713M

Barra de ducha adaptable con accesorios metálicos.  
Adaptable shower with metallic accessories.



**T20002RM250**

320,60 €

99H302792

T100D+RD04M+IDP16+SFT24IDP16+1129C+1128C+RM250+3713M

Barra de ducha adaptable con accesorios metálicos.  
Adaptable shower with metallic accessories.

**T20002RP240**

220,10 €

99H302791

T100D+RD04M+IDP16+SFT24IDP16+1129C+1128C+RP240+3520T1

Barra de ducha adaptable con accesorios ABS.  
Adaptable shower with ABS accessories.



**T20002RPK225**

223,30 €

99H302794

T100D+RD04M+IDP16+SFT24IDP16+1129C+1128C+RPK225+4713P

Barra de ducha adaptable con accesorios ABS.  
Adaptable shower with ABS accessories.



**T20003RP200**

180,40 €

99H303260

T200D+IDP1/2P+SFT19+RP200+2876BT+245002C+247902C

Barra de ducha adaptable con accesorios metálicos.  
Adaptable shower with metallic accessories.

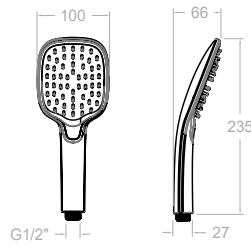

- 4914Q3** 29,30 € **N**  
99Z306272
- 4914Q3NM** 43,90 € **N**  
99Z306274
- 4914Q3NC** 51,20 € **N**  
99Z307382
- 4914Q3OC** 51,20 € **N**  
99Z306276



Ducha de mano de laton con 3 funciones.  
3 functions handshower brass.



**4913K3** 38,30 €  
99Z302621

Ducha de mano semicuadrada con 3 funciones.  
3 function handshower.

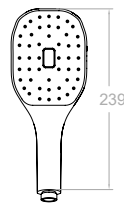

**5840T3** 27,70 €  
261594

Ducha de mano con 3 funciones.  
3 function handshower.

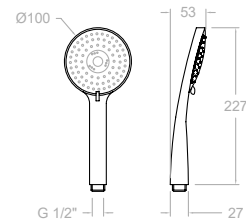

**2876BT** 23,60 €  
261595

Ducha de mano con 3 funciones.  
3 function handshower.

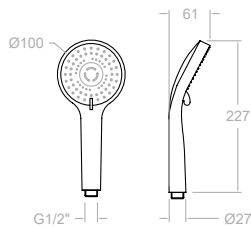

**2877TR** 34,00 €  
99Z300776

Ducha de mano con 3 funciones.  
3 function handshower.

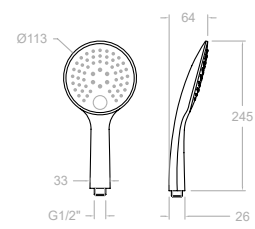

**5811AS** 35,10 €  
261592

Ducha de mano con 3 funciones.  
3 function handshower.

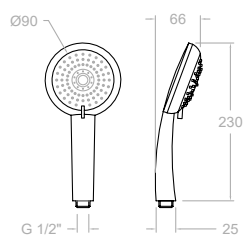

**2876BTM** 31,00 €  
99Z303717

Ducha de mano con 3 funciones.  
3 function handshower.

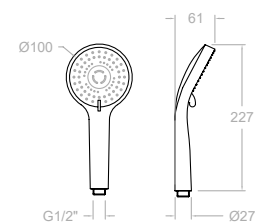



**4912K1** 30,70 €  
99Z302620

Ducha de mano ABS semicuada con 1 función.  
1 function handshower.

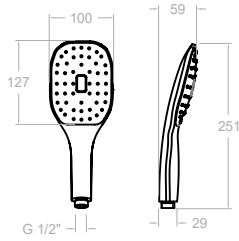

**3520T1** 21,60 €  
261593

Ducha de mano ABS con 1 función.  
1 function handshower.

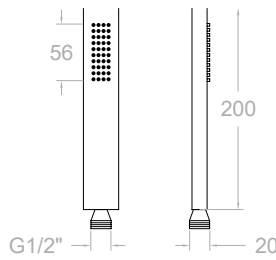
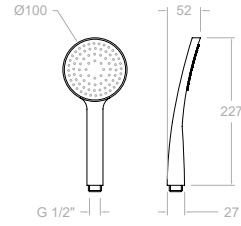

**4716MR** 40,00 €  
99Z305011

**4716MRNM** 72,00 €  
99Z305012

**4716MRNC** 72,00 €  
99Z304946

**4716MROC** 72,00 €  
99Z304947

Ducha de mano de latón con 1 función.  
1 function handshower brass.

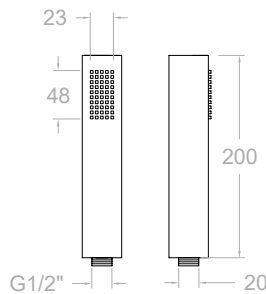

**4716PR** 25,00 €  
99Z305013

**4716PRNM** 38,60 €  
99Z304945

Ducha de mano de ABS con 1 función.  
1 function handshower ABS.



**4713MK** 40,00 €  
255588

**4714KNM** 72,00 €  
99Z302150

Ducha de mano de latón con 1 función.  
1 function handshower brass.

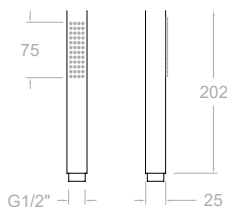

**4713P** 25,00 €  
255579

Ducha de mano de ABS con 1 función.  
1 function handshower ABS.



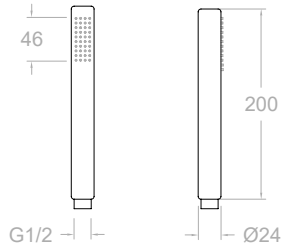

<b>3713M</b> 255597	40,10 €	
<b>3714NM</b> 99Z302151	72,20 €	
<b>3714NC</b> 99Z302329	72,20 €	
<b>3714OC</b> 99Z302152	72,20 €	
<b>3714CUC</b> 99Z307560	72,20 €	

Ducha de mano de Latón con 1 función.  
1 function handshower brass.



**3713P**  
196674 13,80 €

**3713PNM**  
99Z304939 21,50 €

Ducha de mano de ABS con 1 función.  
1 function handshower ABS.

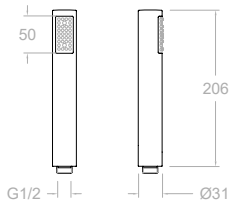

**3518**  
229722 23,70 €

Ducha de mano con 1 función.  
1 function handshower.

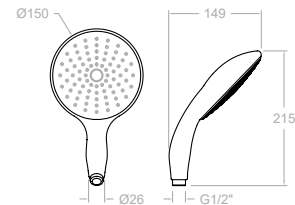

**3521NL**  
241377 19,30 €

Ducha de mano con 1 función.  
1 function handshower.

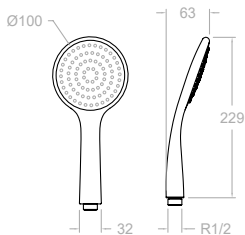

**351502**  
99Z305273 5,40 €

Ducha de mano con 1 función.  
1 function handshower.

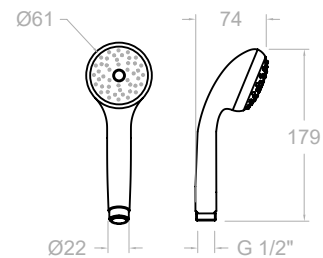

**3524D1**  
99Z306239 10,80 €

Ducha de mano con 1 función.  
1 function handshower.

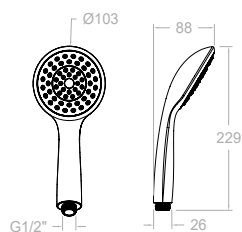

**1224**  
179232 26,70 €

Ducha de mano de latón con 1 función.  
1 function handshower brass.

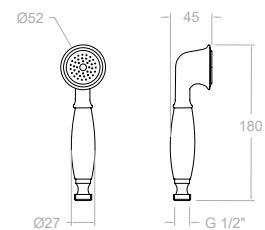





**2471C** 23,10 €  
99Z305989

Flexible para ducha con extremo giratorio G1/2" - G/2".  
Flexible shower connection with swivel end G1/2" - G/2".

1,75 m



**1128C** 14,40 €  
99Z305988

Flexible para ducha con extremo giratorio G1/2" - G/2".  
Flexible shower connection with swivel end G1/2" - G/2".

1,55 m



**2851C** 40,80 €  
300196

Flexible para ducha con extremo giratorio G1/2" - G/2".  
Flexible shower connection with swivel end G1/2" - G/2".

1,50 m



**245002C** 7,10 €  
99Z305105

Flexible para ducha con extremo giratorio G1/2" - G/2".  
Flexible shower connection with swivel end G1/2" - G/2".

1,60 m



**2850C** 26,50 €  
158439

Flexible para empotrados (9989) G1/2-M15x1.  
Flexible for exposed (9989) M15x1.

2,00 m



**2472C** 23,10 €  
99Z305990

Flexible para ducha con extremo giratorio G1/2" - G/2".  
Flexible shower connection with swivel end G1/2" - G/2".

1,75 m



**2475CNC** 41,20 €  
99Z305991

**2475CNC** 41,20 €  
99Z305992

**2475COC** 41,20 €  
99Z305993

**2475CCUC** 41,20 €  
99Z307676

1,75 m



Flexible para ducha con extremo giratorio.  
Flexible shower connection with swivel end.



**2473C** 38,40 €  
99Z300487

Flexible para G1/2-M15X1.  
Flexible hose, G1/2-M15X1.

1,60 m



**354802** 3,80 €  
99Z302082

SopORTE de pared para ducha ABS.  
Shower ABS support.

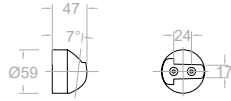

**4748** 7,90 €  
227607

SopORTE de pared para ducha ABS.  
Shower ABS support.



**4741** 33,20 €  
300152

SopORTE de pared para ducha LATON.  
Shower METALL support.



**3726** 7,90 €  
196701

**3726NM** 12,30 €  
99Z304940

SopORTE de pared para ducha ABS.  
Shower ABS support.

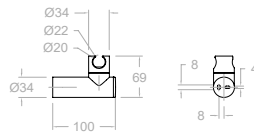

**4726** 24,30 €  
212064

**4726NM** 37,70 €  
99Z304948

SopORTE de pared para ducha ABS.  
Shower ABS support.



**1126** 26,00 €  
165165

SopORTE de pared para ducha metálico.  
Shower metal support.



**3544** 3,80 €  
99Z300793

SopORTE de pared CROMO para ducha.  
CHROME Shower support.



**3726M** 42,70 €  
261799

**372602NM** 76,90 €  
99Z302672

**372602NC** 76,90 €  
99Z302671

**372602OC** 76,90 €  
99Z302673

**372602CUC** 76,90 €  
99Z307677

SopORTE de pared para ducha metálico.  
Shower metal support.

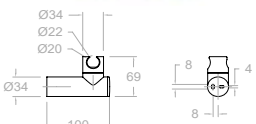

**4726M** 43,60 €  
261800

**472602NM** 67,30 €  
99Z302581

**472602NC** 67,30 €  
99Z304949

**472602OC** 67,30 €  
99Z304950

SopORTE de pared para ducha metálico.  
Shower metal support.



**3553T1** 43,90 €  
257451

Ducha de mano, con flexible para ducha, y soporte de pared.  
Handshower, with flexible connection and wall bracket.



**5812T3** 50,00 €  
257460

Ducha de mano, con flexible para ducha, y soporte de pared.  
Handshower, with flexible connection and wall bracket.



**4949K1** 97,30 €  
99H302622

Ducha de mano, con flexible para ducha, y soporte de pared.  
Handshower, with flexible connection and wall bracket.



**4950K3** 104,90 €  
99H302624

Ducha de mano, con flexible para ducha, y soporte de pared.  
Handshower, with flexible connection and wall bracket.



**655601Q3** 95,10 €  
99H306293  
4914Q3+3726M+2417C

**655601Q3NM** 162,00 €  
99H306294  
4914Q3NM+3726MNM+2417CNM

**655601Q3OC** 169,30 €  
99H306296  
4914Q3OC+3726MOC+2417COC

Ducha ABS de mano, con flexible para ducha, y soporte de pared.  
ABS handshower, with flexible connection and wall bracket.



**5813TR** 99,80 €  
99H300777

Ducha de mano, con flexible para ducha, y soporte de pared.  
Handshower, with flexible connection and wall bracket.



**3349D** 36,10 €  
218895  
3713 + 3726 + 1128 C

**3349PONM** 75,00 €  
99H304938  
3713PNM+3726NM+2475CNM

Ducha ABS de mano, con flexible para ducha, y soporte de pared.  
ABS handshower, with flexible connection and wall bracket.



**3749MO** 105,90 €  
256344  
3713 M+ 3726M+ 2471C ●

**3749DNM** 190,30 €  
99H304941  
3714NM+372602NM+2475CNM ●

**3749DNC** 190,30 €  
99H304942  
3714NC+372602NC+2475CNC ●



**3749DOC** 190,30 €  
99H304943  
3714OC+372602OC+2475COC ●



**4749MR** 106,60 €  
99H305014  
4716MR+4726M+2471C ●

**4759MRNM** 180,50 €  
99H304951  
4716MRNM+472602NM+2475CN ●

**4759MRNC** 180,50 €  
99H304952  
4716MRNC+472602NC+2475CNC ●

**4759MROC** 180,50 €  
99H304956  
4716MROC+472602OC+2475COC ●

Ducha metálica de mano, con flexible para ducha, y soporte de pared.  
Metal handshower, with flexible connection and wall bracket.



**4749PR** 63,80 €  
99H304957  
4716PR+4726+1128C ●

**4749PRNM** 117,60 €  
99H304958  
4716PRNM + 4726NM + 2475CNM ●

Ducha de mano, con flexible para ducha, y soporte de pared.  
Handshower, with flexible connection and wall bracket.



**5849AS** 66,00 €  
241386 ●

Ducha de mano, con flexible para ducha, y soporte de pared.  
Handshower, with flexible connection and wall bracket.



**3558MS** 45,90 €  
229902 ●

Ducha de mano, con flexible para ducha, y soporte de pared.  
Handshower, with flexible connection and wall bracket.



**3049G** 67,10 €  
197043 ●

Ducha de mano, con flexible para ducha, y soporte de pared.  
Handshower, with flexible connection and wall bracket.



**3551NL** 41,60 €  
241395 ●

Ducha de mano, con flexible para ducha, y soporte de pared.  
Handshower, with flexible connection and wall bracket.



**655402VM2** 24,60 €  
99H305276  
351502 + 3544 + 1128 C

Ducha de mano, con flexible para ducha, y soporte de pared.  
Handshower, with flexible connection and wall bracket.



**655302VP2** 16,40 €  
99H305275  
351502 + 3544 + 245002 C

Ducha de mano, con flexible para ducha, y soporte de pared.  
Handshower, with flexible connection and wall bracket.



**3792** 110,40 €  
99H301349  
3796 + 2471C + 3713M

**3792NM** 198,80 € **N**  
99H308112  
3796NM+3714NM+2475CNM

**3792NC** 198,80 € **N**  
99H308114  
3796NC+3714NC+2475CNC

**3792OC** 198,80 € **N**  
99H308115  
3796OC+3714OC+2475COC

Ducha de mano, con flexible para ducha, y soporte de pared.  
Handshower, with flexible connection and wall bracket.



**4792** 122,30 €  
99H301350  
4713MK + 2471C + 4796

**4793NM** 220,30 €  
99H302167  
4714KNM+4798NM-2475CNM

**4792NC** 220,20 € **N**  
99H308121  
4798NC+4716MRNC+2475CNC

**4793NM** 220,20 € **N**  
99H308123  
4798OC+4716MROC+2475COC

Ducha de mano, con flexible para ducha, y codo con soporte de pared.  
Handshower, with flexible connection and wall bracket.



**3981P** 84,30 € **N**  
99H308105  
3796+3713P+2471C



**3782BT** 94,10 € **N**  
99H308106  
3796+2876BT+2471C

**3782BTNM** 157,60 € **N**  
99H308107  
3796NM+2876BTNM+2475CNM

Ducha metálica de mano, con flexible para ducha, y soporte de pared.  
Metal handshower, with flexible connection and wall bracket.



**3783Q3** 99,80 € **N**  
 99H308108  
 3796+4914Q3+2471C

**3783Q3NM** 170,50 € **N**  
 99H308109  
 4716MRNM+472602NM+2475CN

Ducha metálica de mano, con flexible para ducha, y soporte de pared.  
 Metal handshower, with flexible connection and wall bracket.



**3783Q3NC** 177,80 € **N**  
 99H308110  
 3796NC+4914Q3NC+2475CNC

**3783Q3OC** 177,80 € **N**  
 99H308111  
 3796OC+4914Q3OC+2475COC

Ducha metálica de mano, con flexible para ducha, y soporte de pared.  
 Metal handshower, with flexible connection and wall bracket.



**4781P** 107,40 € **N**  
 99H308116  
 4796+4713P+2471C

Ducha metálica de mano, con flexible para ducha, y soporte de pared.  
 Metal handshower, with flexible connection and wall bracket.



**4783Q3** 111,70 € **N**  
 99H308117  
 3796+4914Q3+2471C

**4783Q3NM** 192,10 € **N**  
 99H308118  
 4798NM+4914Q3NM+2475CNM

**4783Q3NC** 199,40 € **N**  
 99H308119  
 4798NC+4914Q3NC+2475CNC

**4783Q3OC** 199,40 € **N**  
 99H308120  
 4798OC+4914Q3OC+2475COC

Ducha metálica de mano, con flexible para ducha, y soporte de pared.  
 Metal handshower, with flexible connection and wall bracket.

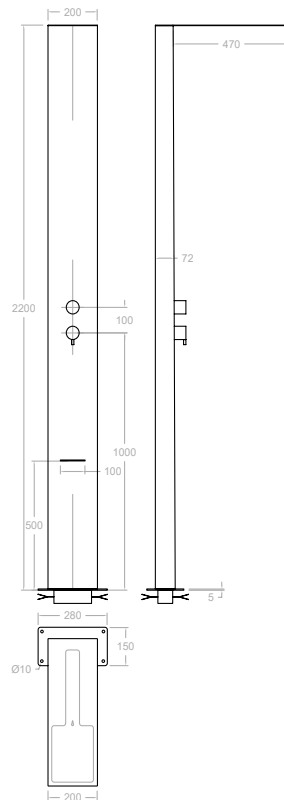

**COLEX01** 5.939,80 € **N**  
 99Z302628

Columna de ducha para piscina, integramente de acero inoxidable con tratamiento pasivado para exterior.  
 Shower column for swimming pool, made entirely of stainless steel with outdoor treatment.





# Accesorios baño

Colección Collection



## Instalación sistema dual

### Fijación mecánica

- Posicionar los puntos donde taladrar.
- Atornillar la pieza de unión fuertemente en cada taco.
- Introducir el accesorio en las piezas de unión y fijar fuertemente con el tornillo prisionero.

### Fijación adhesiva

Sealant fix: ¡olvídate de agujerear las paredes con el pegamento Sealant fix!

- Fácil de aplicar, fácil de retirar.
- Resistente al agua.
- No tóxico.

OPCIONAL: Se pueden aplicar ambos sistemas de fijación a la vez.

## Instalación sistema dual

### Mechanical fixing

- Position the points where to drill.
- Screw the connecting piece tightly into each anchor.
- Insert the accessory in the connecting pieces and fix it with the set screw.

### Mechanical fixing

Sealant fix: forget about drill the walls with Sealant Fix glue!

- Easy to apply, easy to remove.
- Waterproof.
- Not toxic.

OPTIONAL: Both fixing systems can be applied at the same time.

## Acabados disponibles Finishing availables



 **Cromo**  
Chrome



 **Negro mate**  
Black matte



 **Inox cepillado**  
Brushed inox



 **Oro cepillado**  
Brushed gold



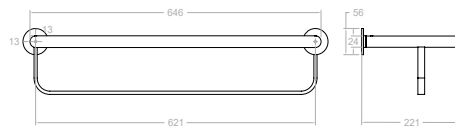

**TOAL03** 141,60 €  
99Z306201

Toallero estante (XL).  
Towel rack shelf (XL).

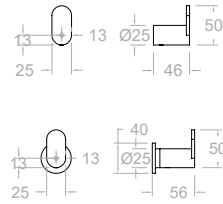

**COLG01** 20,80 €  
99Z306189

Colgador.  
Hook.

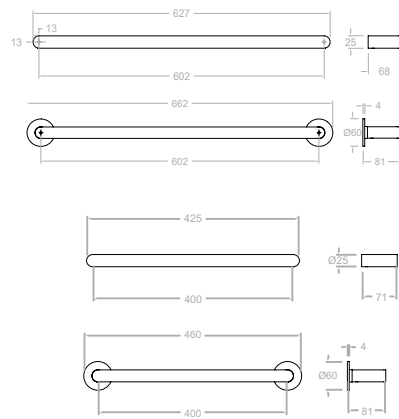

**TOAL02** 63,70 €  
99Z306197

Toallero XL.  
Towel rack Large.



**TOAL04** 55,00 € **N**  
99Z307448

Toallero L 400 mm.  
Towel rack Large 400 mm.

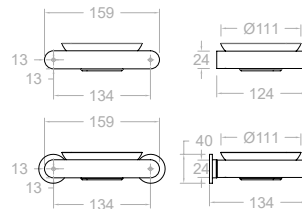

**SOP02** 62,00 €  
99Z306209

Jabonera.  
Soap dish.

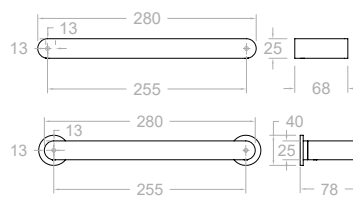

**TOAL01** 48,50 €  
99Z306193

Toallero (M).  
Towel rack (M).

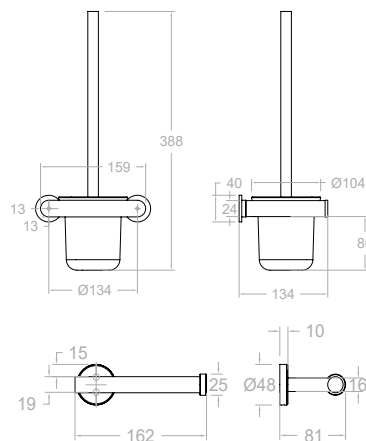

**ESCO01** 72,70 €  
99Z306213

Escobillero de pared.  
Toilet brush.



**PORT01** 33,60 €  
99Z306217

Portapapel.  
Paper holder.



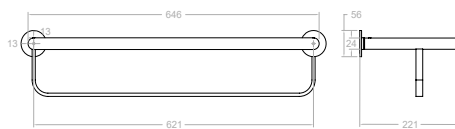

**TOAL03NM** 122,30 €  
99Z306202

Toallero estante (XL).  
Towel rack shelf (XL).

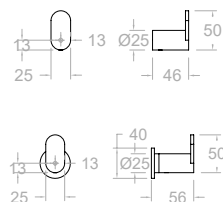

**COLG01NM** 31,10 €  
99Z306190

Colgador.  
Hook.

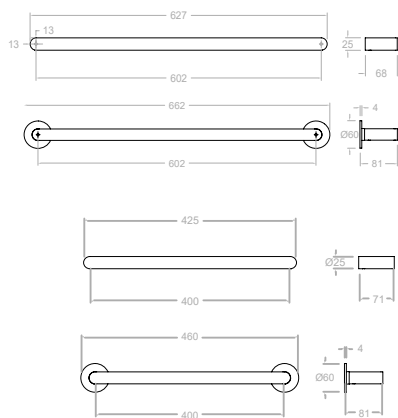

**TOAL02NM** 95,60 €  
99Z306198

Toallero L.  
Towel rack Large.



**TOAL04NM** 82,40 €  
99Z307449

Toallero L 400 mm.  
Towel rack Large 400 mm.

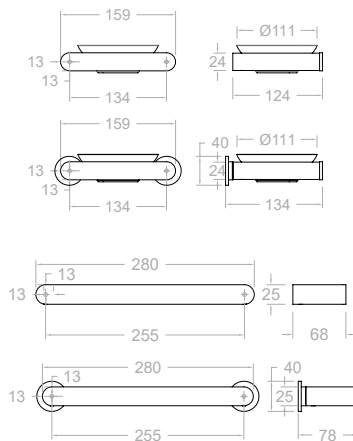

**SOP02NM** 93,20 €  
99Z306210

Jabonera.  
Soap dish.



**TOAL01NM** 72,60 €  
99Z306194

Toallero (M).  
Towel rack (M).

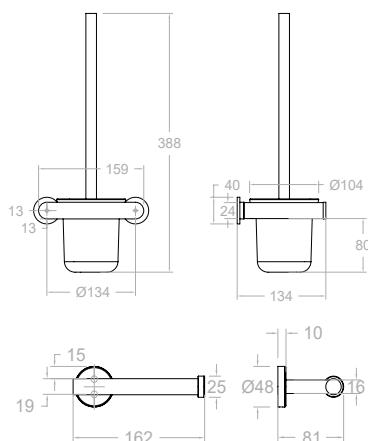

**ESCO01NM** 109,10 €  
99Z306214

Escobillero de pared.  
Toilet brush.



**PORT01NM** 50,30 €  
99Z306218

Portapapel.  
Paper holder.



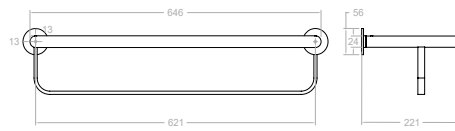

**TOAL030C** 247,60 €  
99Z306203

Toallero estante (XL).  
Towel rack shelf (XL).

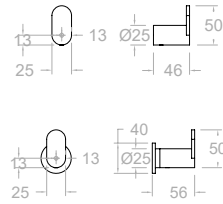

**COLG010C** 36,30 €  
99Z306191

Colgador.  
Hook.

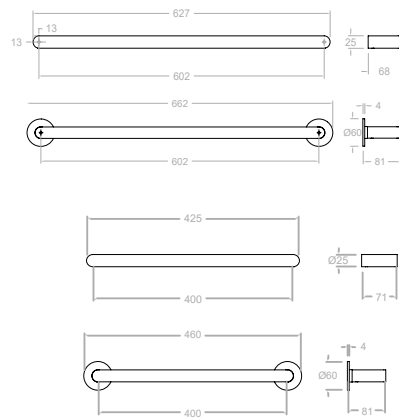

**TOAL020C** 111,50 €  
99Z306199

Toallero L.  
Towel rack Large.



**TOAL040C** 96,20 € **N**  
99Z307451

Toallero L 400 mm.  
Towel rack Large 400 mm.

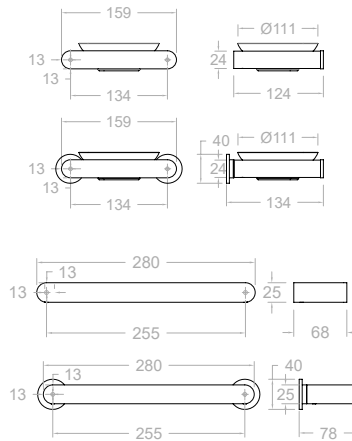

**SOP020C** 108,60 €  
99Z306211

Jabonera.  
Soap dish.



**TOAL010C** 84,80 €  
99Z306195

Toallero (M).  
Towel rack (M).

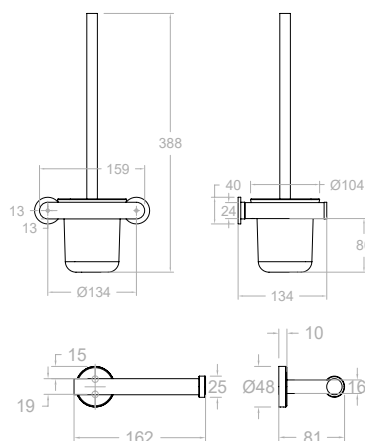

**ESC0010C** 127,30 €  
99Z306215

Escobillero de pared.  
Toilet brush.



**PORT010C** 58,70 €  
99Z306219

Portapapel.  
Paper holder.



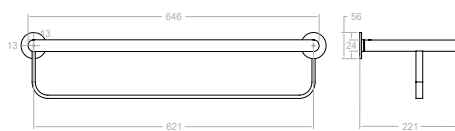

**TOAL03IC** 93,20 €  
99Z306204

Toallero estante (XL).  
Towel rack shelf (XL).

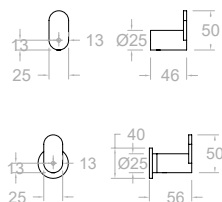

**COLG01IC** 18,00 €  
99Z306192

Colgador.  
Hook.

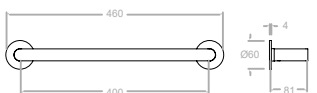
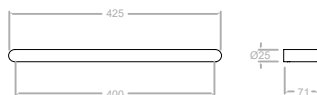

**TOAL02IC** 52,10 €  
99Z306200

Toallero L.  
Towel rack Large.



**TOAL04IC** 45,00 € **N**  
99Z307450

Toallero L 400 mm.  
Towel rack Large 400 mm.

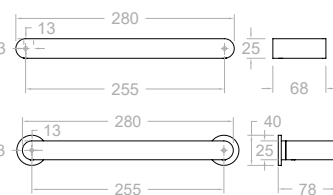
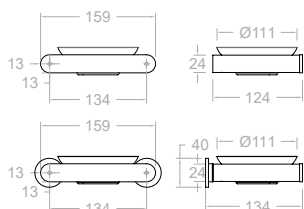

**SOP02IC** 50,90 €  
99Z306212

Jabonera.  
Soap dish.



**TOAL01IC** 39,70 €  
99Z306196

Toallero (M).  
Towel rack (M).

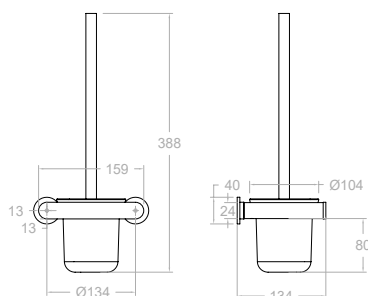

**ESCO01IC** 60,90 €  
99Z306216

Escobillero de pared.  
Toilet brush.

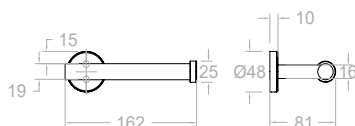

**PORT01IC** 24,90 €  
99Z306220

Portapapel.  
Paper holder.







# Wc

Colección Collection



VER VIDEO



WATCH VIDEO



### Características Técnicas

- Previene los escapes por presión estática en flexo y duchita.
- Evita siniestros por inundaciones.
- Evita recirculación del agua.
- Montaje en dos cuerpos.
- Garantía de 5 años en grifería y 2 años en complementos.

### Technical Characteristics

- Prevents leakage by static pressure in the flexible and shower.
- Avoid damages by floods.
- Avoid water recirculation.
- Assembly in two bodies.
- 5 years warranty on taps and 2 years on accessories.



### Acabados disponibles Finishing availables



Cromo  
Chrome



Negro mate  
Black matte



Niquel cepillado  
Brushed nickel



Oro cepillado  
Brushed gold





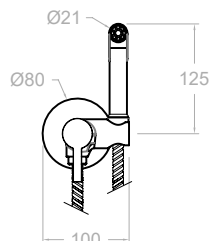
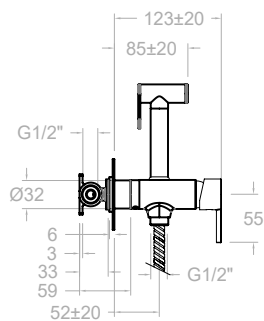

**336801WC** 186,10 €

99F302081  
336801S+9552+247903C

**336801WCNM** 279,20 €

99F305564  
336801SNM+9552NM+1121CNM

**336801WCNC** 325,80 €

99F305571  
336801SNC+9552NC+1121CNC

**336801WCOC** 325,80 €

99F305569  
336801SOC+9552OC+1121COC

Monomando empotrado de WC magnet con cierre doble cierre de seguridad y duchita.

Single lever WC magnet with double closing safety lock and shower.

Bar	Temperature
1 Bar	RECOM. < 55
2 Bar	MAX. < 65
3 Bar	

**336801S** 154,90 €

99F302575

**336801SNM** 232,50 €

99F305561

**336801SNC** 271,20 €

99F305570

**336801SOC** 271,20 €

99F305568

Monomando empotrado de WC magnet con cierre doble cierre de seguridad sin accesorios.

Single lever WC magnet with double closing safety lock without accessories.

Cartucho Cartridge: 25000-2

**PME01** 36,80 €

AAZ302651

Placa necesaria para montaje en pladur.  
Plate needed for mounting in plasterboard.

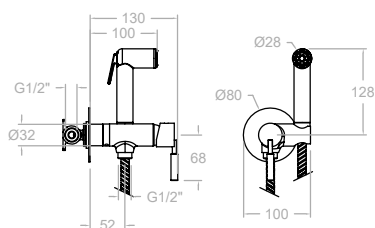

**756801WC** 161,90 €

99F302574

Monomando empotrado de WC magnet con cierre doble cierre de seguridad y duchita.

Single lever WC magnet with double closing safety lock and shower.

**756801S** 144,60 €

99F302573

Monomando empotrado de WC magnet con cierre doble cierre de seguridad sin accesorios.

Single lever WC magnet with double closing safety lock without accessories.

**PME01** 36,80 €

AAZ302651

Placa necesaria para montaje en pladur.  
Plate needed for mounting in plasterboard.

Cartucho Cartridge: 25000-2



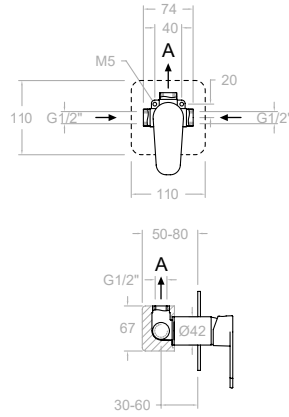

<b>364501</b> 36F305165 361801S-3796+9552+1120CHP	191,80 €	●
<b>364501NM</b> 36F305167 361801SNM+3796NM+9552NM+1121CNM	342,00 €	●
<b>364501NC</b> 36F305166 361801SNC+3796NC+9552NC+1121CNC	342,00 €	●
<b>364501OC</b> 36F305168 361801SNOC+3796OC+9552OC+1121COC	342,00 €	●

Monomando empotrado de WC con duchita.  
Single lever WC with shower.

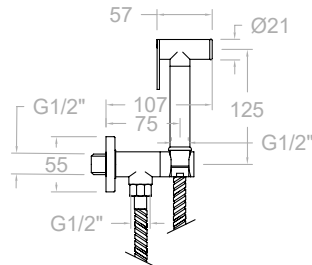

<b>114602</b> 99F301568	170,30 €	●
----------------------------	----------	---

Conjunto de duchita para WC, de una agua con llave de paso automática.  
WC set with automatic stop.



3798+9552+1120CHP

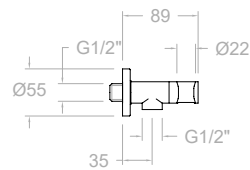

<b>3798</b> 239559	126,00 €	●
-----------------------	----------	---

Llave de paso de 1/2" con cierre automático.  
Angle valve with authomatic stop.

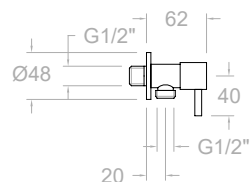

<b>3797</b> 230514	15,60 €	●
<b>3797NM</b> 99Z306002	23,40 €	●

Llave de paso cerámica de 1/2".  
Ceramic angle valve.



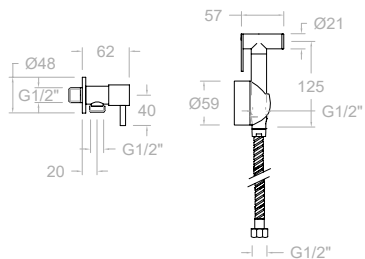

**114102**

99F301561

63,80 €



Conjunto para WC con duchita de latón.  
WC set with brass shattaf.

3797+9552+354802+1120CHP

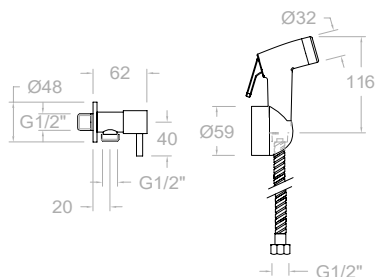

**114202**

99F301562

40,70 €



Conjunto para WC con duchita de ABS.  
WC set with ABS shattaf.

3797+955102+354802+1120CHP

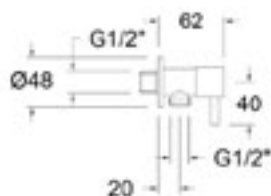

**114702**

99F301563

29,50 €



Conjunto para WC.  
WC set.

3797+3799+247902C

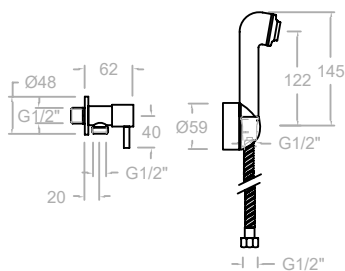

**114902**

99F301565

43,40 €



Conjunto para WC.  
WC set.

3797+9553+354802+1120CHP



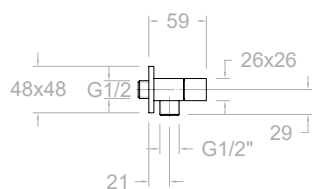

**4797**

242304

35,80 €



Llave de paso cerámica de 1/2".  
Ceramic angle valve 1/2" ..

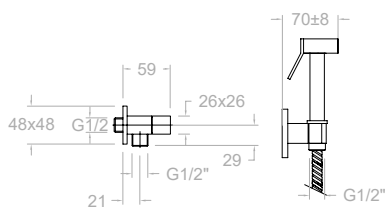

**411902**

99F301571

120,00 €



Conjunto para WC.  
WC set.

4797+4552+4741+1120CHP



**411702**

99F301569

52,20 €



Conjunto para WC.  
WC set.

4797+3799+1120CHP

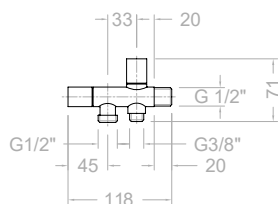

**3793**

99Z303339

45,00 €



**3795**

300150

62,40 €

Llave de paso cerámica con dos salidas (cisterna WC+ duchita WC).  
Ceramic angle valve with 2 outlets (WC tank + shattaf).

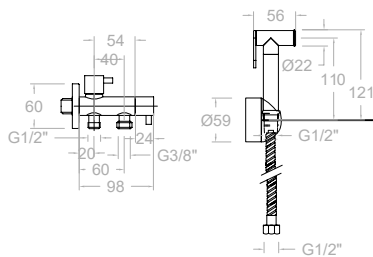

**113702**

99F301567

110,60 €



Conjunto de WC para duchita y cisterna de WC.  
WC set for shattaf and WC tank.

3795+9552+354802+1120CHP

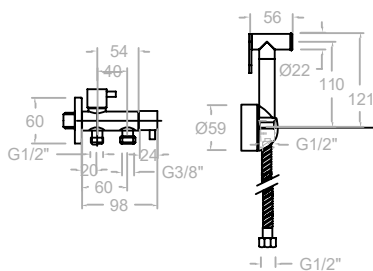

**113502**

99F301566

87,60 €



Conjunto de WC para duchita y cisterna de WC.  
WC set for shattaf and WC tank.

3795+955102+354802+1120CHP

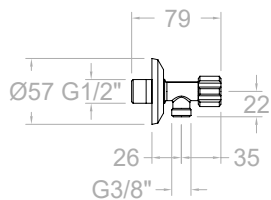

**1288**

AAZ301266

10,60 €

Llave de paso de 1/2" y 3/8".  
Standard angle valve 1/2" and 3/8".

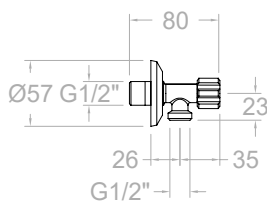

**1289**

AAZ301267

10,50 €

Llave de paso de 1/2" y 1/2".  
Standard angle valve 1/2" and 1/2".



**115601**

99F301558

35,60 €



Conjunto para WC.  
WC set.

1289+955102+354802+1120CHP

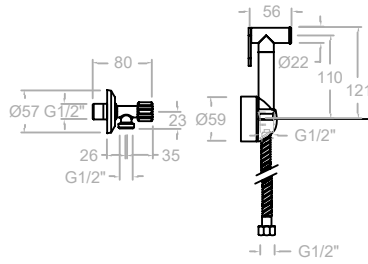

**115701**  
99F301559

58,70 €



Conjunto para WC.  
WC set.

1289+9552+354802+1120CHP



**115801**  
99F301560

23,80 €



Conjunto para WC.  
WC set.

1289+3799+1129C-2

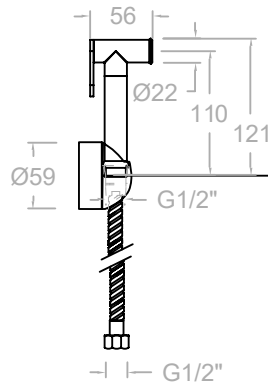

**115202**  
99F301574

48,20 €



Conjunto WC sin llave de paso.  
WC set without angle valve.

9552+354802+1120CHP

**115102**  
99F301572

25,10 €

955102+354802+1120CHP

**115103**  
99F303323

24,10 €

955102+354802+1122CHP



**1843S**  
18F301575

61,80 €



Monomando mural para WC Titanium 110 mm, cromado.  
Single lever mixer for shattaf 110 mm, chromed.

**3643S**  
36F301692

68,20 €

Monomando mural para WC New Fly 110 mm, cromado.  
Single lever mixer for shattaf 110 mm, chromed.

Cartucho Cartridge: 35000-3



**9343S** 69,30 €  
93F301583

Conjunto de WC para duchita y cisterna de WC.  
WC set for shattaf and WC tank.



**3343S** 68,20 €  
33F301581

Conjunto de WC para duchita y cisterna de WC.  
WC set for shattaf and WC tank.

Cartucho Cartridge: 35000-3



**6443S** 63,70 €  
64F301580

Conjunto de WC para duchita y cisterna de WC.  
WC set for shattaf and WC tank.



**574301S** 62,70 €  
57F304992

Conjunto de WC para duchita y cisterna de WC.  
WC set for shattaf and WC tank.

Cartucho Cartridge: 35000-3



+



**1843WC** 78,10 €  
99F300597  
1843S+3799+1120CHP

**3643WC** 84,50 €  
36F301693  
3643S+3799+1120CHP

**934302WC** 85,70 €  
93F301343  
9343S+3799+1120CHP

**334302WC** 84,50 €  
33F301342  
3343S+3799+1120CHP

**6443WC** 79,90 €  
99F300600  
6443S+3799+1120CHP

**574301WC** 79,10 €  
57F304993  
574301S+3799+1120CHP

Monomando mural para WC con accesorios de ABS, cromado.  
Single lever wall mounted WC mixer with ABS accessories.

Cartucho Cartridge: 35000-3





+



**184403WC**

18F305170  
1843S+9559+354802+1120CHP

124,30 €



**364403WC**

36F305172  
3643S+9559+354802+1120CHP

131,20 €



**934403WC**

93F305175  
9343S+9559+354802+1120CHP

132,60 €



**334403WC**

33F305171  
3343S+9559+354802+1120CHP

131,20 €



**644403WC**

64F305174  
6443S+9559+354802+1120CHP

126,50 €



**574403WC**

57F305173  
574301S+9559+354802+1120CHP

125,70 €



Monomando mural para WC con ducha de metal, cromado.  
Single lever mixer 110 mm with shattaf set, chromed.

Cartucho Cartridge: 35000-3



**4943S**

49F301576  
XX43+4900-35+1329

109,60 €



Monomando mural para WC.  
Single lever wall mounted WC mixer.

Cartucho Cartridge: 35000-3



**4943WC**

99F300602  
4943S+3799+1120CHP

126,20 €



Monomando mural para WC con accesorios.  
Single lever wall mounted WC mixer with accessories.

Cartucho Cartridge: 35000-3

**4944WC**

99F300800

4943S+4552+4741+1120CHP

194,70 €

**Monomando mural para WC con accesorios.**

Single lever wall mounted WC mixer with accessories.

Cartucho Cartridge: 35000-3

**1121CNM**

99Z302172

24,90 €

**1121CNC**

99Z302323

24,90 €

**1121COC**

99Z302324

24,90 €

**Flexible 1,2 m.**

High pressure flexible hose 1,2 m.

**1120CHP**

AAZ301305

13,80 €

**Flexible de alta presión para Wc 1,2 m.**

High pressure flexible hose for shataff 1,2 m.

**1122CHP**

AAZ302809

13,80 €

**Flexible de alta presión para Wc 1 m.**

High pressure flexible hose for shataff 1 m.

**2479C**

300198

18,30 €

**Flexible de alta presión para Wc 1,2 m.**

High pressure flexible hose for shataff 1,2 m.

**247902C**

99Z305409

10,00 €

**Flexible de alta presión para Wc 1 m.**

High pressure flexible hose for shataff 1 m.

**354802**

99Z302082

3,80 €

**Soporte de pared para ducha.**

Shower support for floor columns.

**4741**

300152

33,20 €

**4741NM**

99Z306003

49,60 €

**Soporte de pared para ducha.**

Shower support for floor columns.





**4748** 7,90 €  
227607

Soporte de pared para ducha.  
Shower support for floor columns.



**3796** 47,40 €  
227490

**3796NM** 85,40 €  
99Z302357

**3796NC** 85,40 €  
99Z302356

**3796OC** 85,40 €  
99Z302358

Codo de salida de agua y soporte fijo redondo.  
Water outlet elbow.



**9552** 30,50 €  
230037

**9552NM** 45,70 €  
99Z304159

**9552NC** 54,70 €  
99Z304161

**9552OC** 54,70 €  
99Z304160

Ducha de latón de mano para WC.  
Brass shataff for WC.



**9553** 13,20 €  
199833

Ducha de mano para WC.  
Handshower for WC.



**4552** 37,90 €  
300151

Ducha de mano para WC.  
Handshower for WC.



**955102** 7,70 €  
99Z304035

Ducha de mano para WC.  
Handshower for WC.



**3799** 2,40 €  
240621

Director de chorro M1/2.  
Chrome spray shower M1/2.



**9559** 45,20 €  
99Z304408

Ducha de mano para WC.  
Handshower for WC.



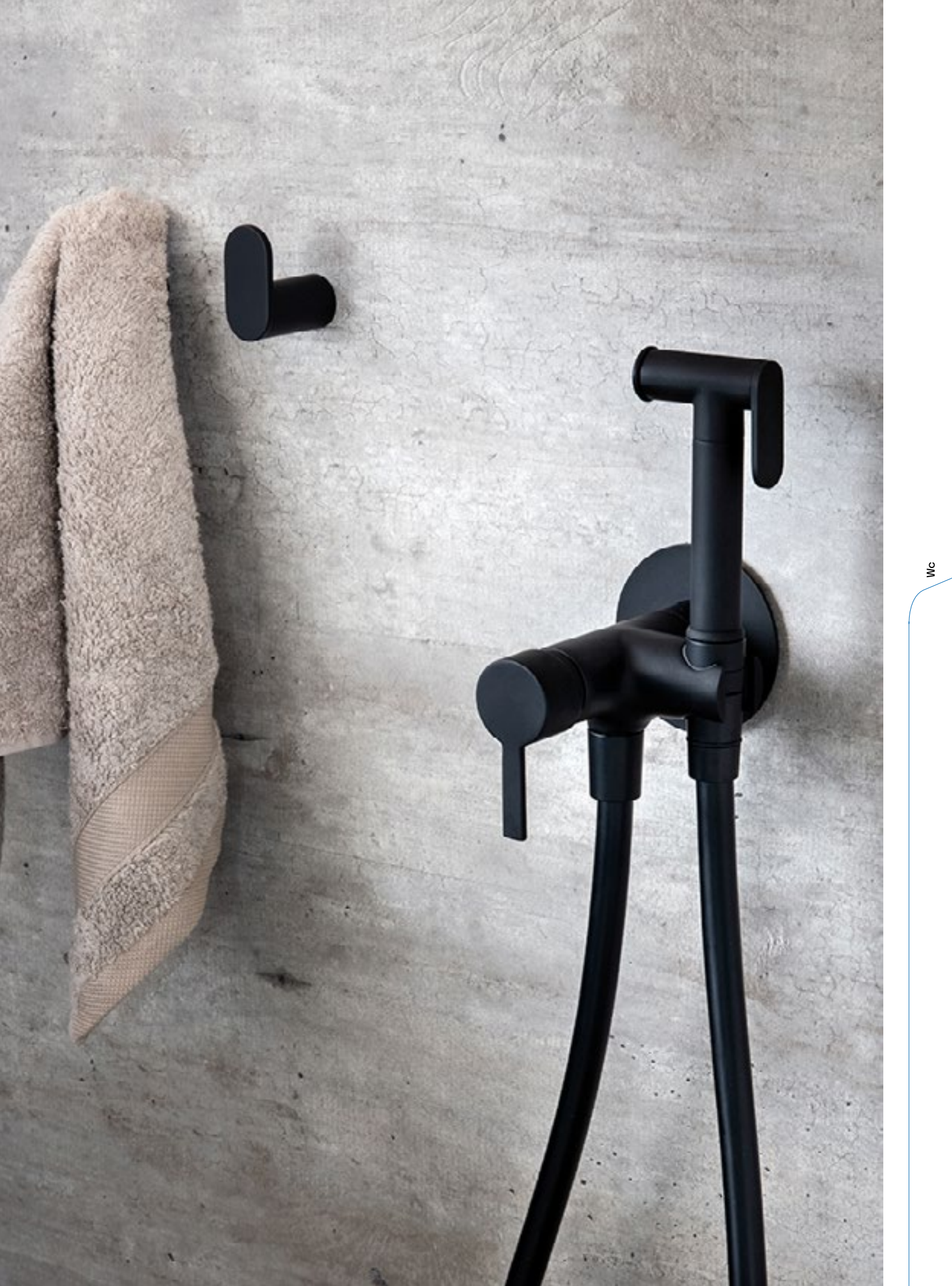

# Cocinas Kitchen

ramonsoler.







Pure water

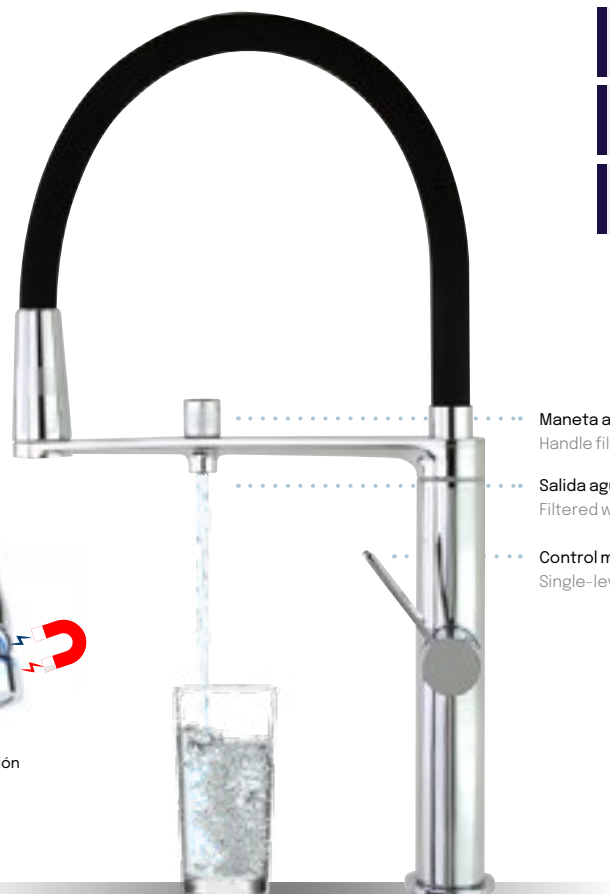

Campo magnético  
Magnetic field



Colocación y extracción  
sin esfuerzo se  
autoposiciona por el  
campo magnético.

Maneta agua filtrada  
Handle filtered water

Salida agua filtrada  
Filtered water output

Control monomando  
Single-lever control

<b>898801MC</b> 38E306084	328,00 €	N
<b>898801MCNM</b> 38E306085	492,00 €	N
<b>898801MCNC</b> 38E306086	492,00 €	N

Fregadero profesional con circuito para agua purificada.  
High swivel about sink mixer with circuit for purified water.

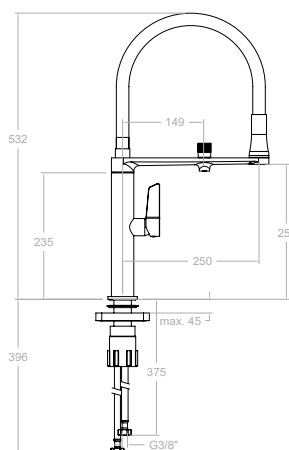

Cartucho Cartridge: 25000-2 + 8991

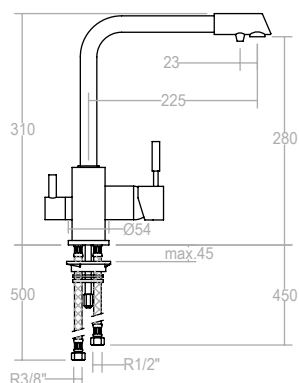

<b>7589</b> 255336	254,30 €	
-----------------------	----------	--

Fregadero caño alto giratorio, con circuito para agua purificada.  
High swivel about sink mixer with circuit for purified water.

Cartucho Cartridge: 35000 (3750) + 3791



<b>3785</b> 220101	134,80 €	
-----------------------	----------	--

Filtro de carbono activo. Incluye: Cartucho filtrador de agua, sujeción a pared y conexiones a grifo y a toma de agua (llaves de paso NO incluidas).

Activated carbon water filtration Include: Filtered water cartridge, wall fasten connections and valve and water connection (Angle valves NOT included).

<b>3786</b> 220110	86,70 €	
-----------------------	---------	--

Cartucho de filtro de duración aproximada de 12 meses.  
Filter cartridge (last approximately 12 months).

Kitchen Magnet

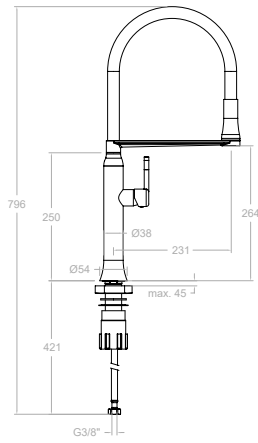

**386801MA** 258,80 €

38E303484

**386801MACU** 461,30 €

38E304205

Monomando con duchita 1 jet orientable y caño flexible de silicona para cocina.

Sink mixer with extensible hose and flexible kitchen spout.



Cartucho Cartridge: 25000-2

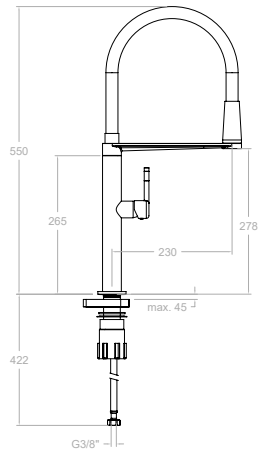

**388801MA** 233,60 €

38E303469

**388801MACU** 416,40 €

38E305118

Monomando con duchita 1 jet orientable y caño flexible de silicona para cocina.

Sink mixer with extensible hose and flexible kitchen spout.



Cartucho Cartridge: 25000-2

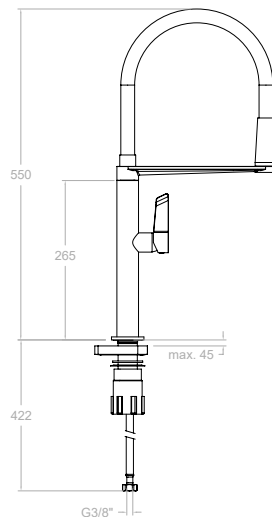

**388801MC** 233,60 €

38E303421

**388801MCNM** 416,40 €

38E303481

**388801MCNC** 416,40 €

38E304206

Monomando con duchita 1 jet orientable y caño flexible de silicona para cocina.

Sink mixer with extensible hose and flexible kitchen spout.



Cartucho Cartridge: 25000-2



## Square

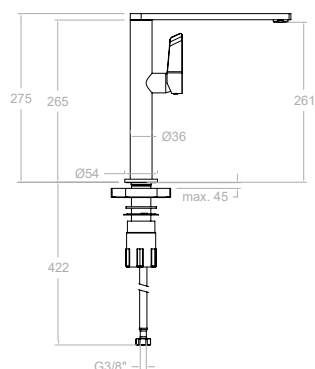

**388401MC**  
38E303408

251,30 €



**388401MCNM**  
38E303420

447,80 €



**388401MCNC**  
38E303600

447,80 €



Fregadero caño alto giratorio.  
High swivel about sink mixer.



Cartucho Cartridge: 25000-2

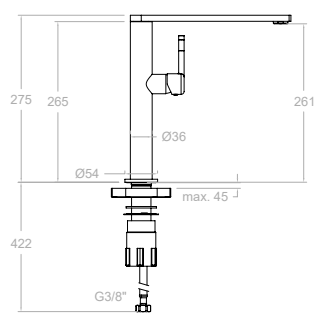

**388401MA**  
38E303410

251,30 €



**388401MACU**  
38E305119

447,80 €



Fregadero caño alto giratorio.  
High swivel about sink mixer.



Cartucho Cartridge: 25000-2

## Professional

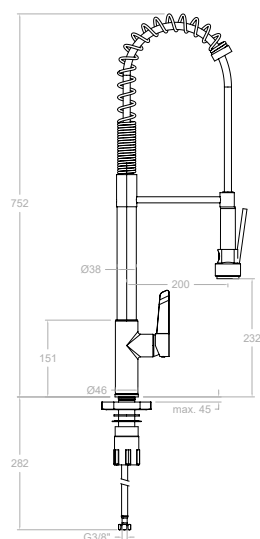

**386701MC**  
38E303480

463,00 €



Monomando con duchita orientable para gran cocina.  
Sink mixer with extensible hose for great kitchens.



BRASS  
LATON

Cartucho Cartridge: 35100 (6689-2)

Professional

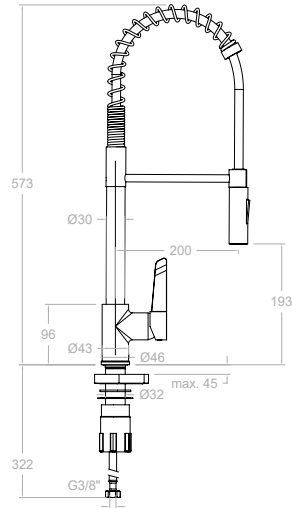

**386601MC**  
38E303479

265,10 €

Monomando con duchita orientable para gran cocina.  
Sink mixer with extensible hose for great kitchens.



Cartucho Cartridge: 35100 (6689-2)

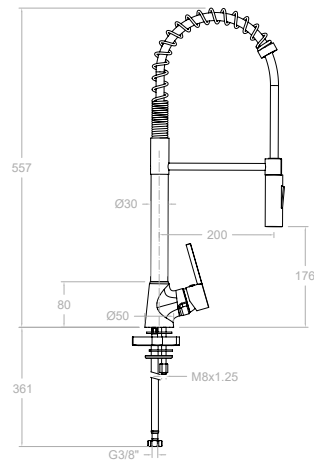

**386501MD**  
38E303603

239,90 €

Monomando con duchita orientable para gran cocina.  
Sink mixer with extensible hose for great kitchens.



Cartucho Cartridge: 35100 (6689-2)

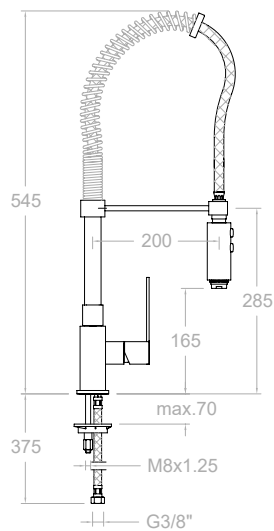

**4966**  
223377

710,40 €

Monomando con duchita 2 jets orientable para gran cocina.  
Sink mixer with extensible hose and double jet hand shower for great kitchens.



Cartucho Cartridge: 25000-2 (4750)

Extraíbles

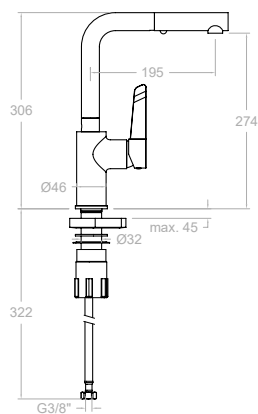

**381901H1MC**

38E304202

296,00 €

Monomando para fregadero con duchita metálica 2 jets extraíble.

Sink mixer with extensible hose and metal handshower (2 jets).

Cartucho Cartridge: 35100-2

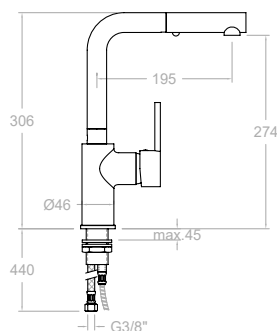

**331902H1**

33E301600

301,00 €

Monomando para fregadero con duchita metálica 2 jets extraíble.

Wash basin mixer with extensible hose and metal handshower (2 jets).

Cartucho Cartridge: 35100-2

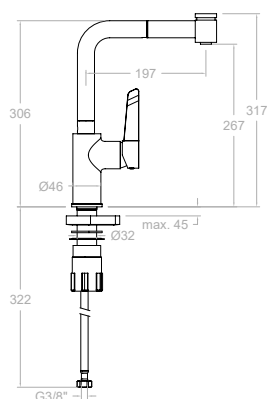

**381901H2MC**

38E304203

269,80 €

Monomando para fregadero con duchita ABS 2 jets extraíble.

Sink mixer with extensible hose and ABS handshower (2 jets).

Cartucho Cartridge: 35100-2

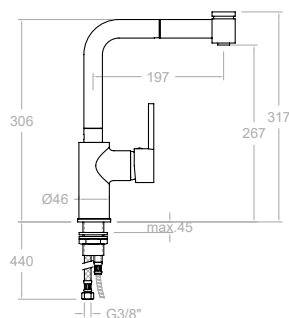

**331902H2**

33E301601

275,00 €

Monomando para fregadero con duchita ABS 2 jets extraíble.

Wash basin mixer with extensible hose and ABS handshower (2 jets).

Cartucho Cartridge: 35100-2



Extraíbles

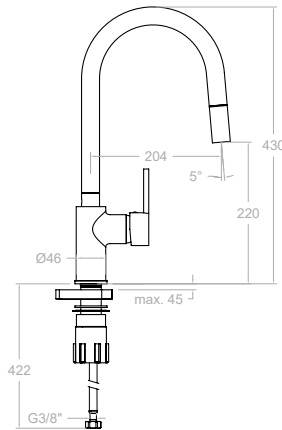
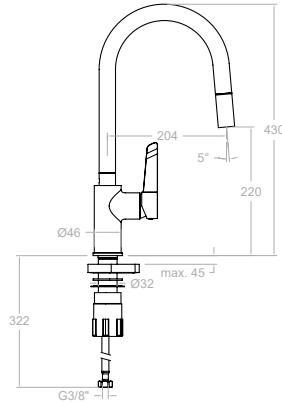

**387901V1MC**  
38E304200

310,00 €

Monomando para fregadero con duchita metálica 2 jets extraíble.

Sink mixer with extensible hose and metal handshower (2 jets).

Cartucho Cartridge: 35100-2

**337902V1**  
33E301598

314,40 €

Monomando para fregadero con duchita metálica 2 jets extraíble.

Wash basin mixer with extensible hose and metal handshower (2 jets).

Cartucho Cartridge: 35100-2

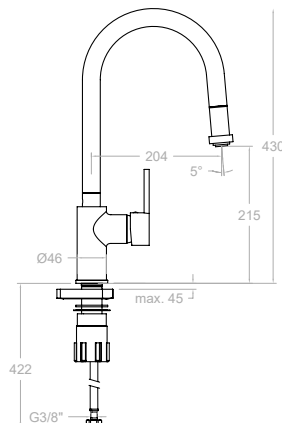
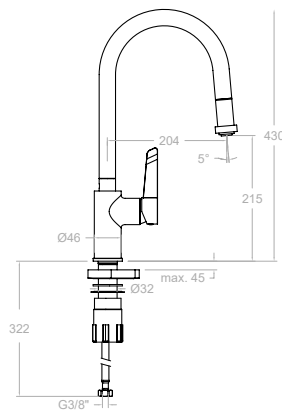

**387901V2MC**  
38E304201

338,30 €

Monomando para fregadero con duchita ABS 2 jets extraíble.

Sink mixer with extensible hose and ABS handshower (2 jets).

Cartucho Cartridge: 35100-2

**337902V2**  
33E301599

342,50 €

Monomando para fregadero con duchita ABS 2 jets extraíble.

Wash basin mixer with extensible hose and ABS handshower (2 jets).

Cartucho Cartridge: 35100-2



Altos

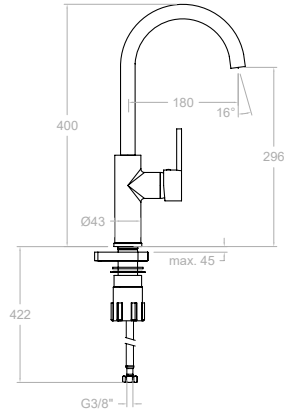

**380602MC**  
38E304233

127,60 €

Monomando para fregadero con caño giratorio.  
Wash basin mixer with swivel spout.

Cartucho Cartridge: 35100 (6689-2)



**330602**  
33E301596

137,30 €

**330602NM**  
33E306168

209,80 €

**330602CUC**  
33E305120

249,60 €

Monomando para fregadero con caño giratorio.  
Wash basin mixer with swivel spout.

Cartucho Cartridge: 35100 (6689-2)

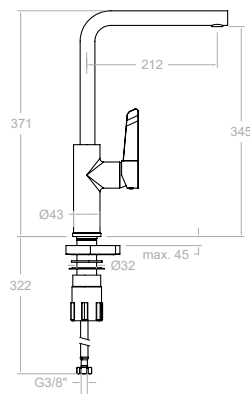

**382902MC**  
38E304204

183,50 €

Monomando para fregadero con duchita ABS 2 jets extraíble.  
Sink mixer with extensible hose and ABS handshower (2 jets).

Cartucho Cartridge: 35100 (6689-2)



**332902**  
33E301602

184,10 €

**332902NM**  
33E306169

281,30 €

**332902CUC**  
33E305121

334,30 €

Monomando para fregadero de caño giratorio alto.  
Sink mixer with swivel spout.

Cartucho Cartridge: 35100 (6689-2)

Abatible

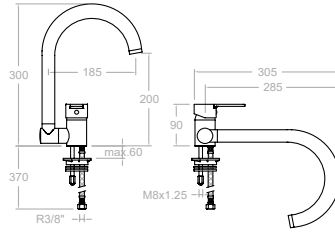

9369  
227346

213,20 €

3369  
221676

208,90 €

Monomando para fregadero con caño abatible.  
Sink mixer with swivel and folding spout.

Cartucho Cartridge: 40100-2 (3388-2)



Bajos

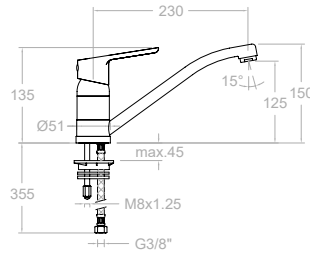

1809  
18E300516

59,30 €

Monomando para fregadero con caño giratorio de tubo.  
Sink mixer with swivel spout.

Cartucho Cartridge: 40200-2 (3388-2 K C2)

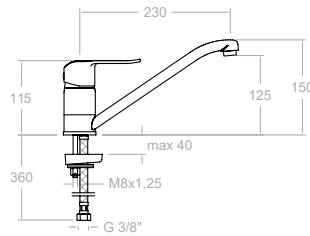

6499  
261762

96,10 €

Monomando para fregadero con caño giratorio. Sistema de apertura en agua fría.  
Cold water opening low spout cast kitchen mixer.

Cartucho Cartridge: 40300-2 (3388-2 K C3)

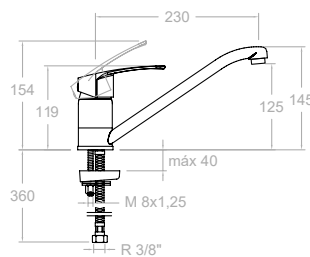

579901  
57E303578

86,80 €

Monomando para fregadero con caño giratorio. Sistema de apertura en agua fría.  
Cold water opening low spout cast kitchen mixer.

Cartucho Cartridge: 40300-2 (3388-2 K C3)





## Clasicas

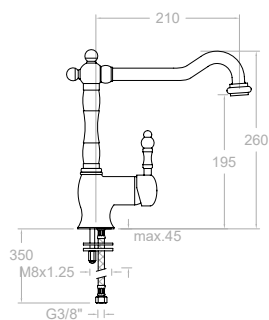

**3129**  
31E302780

437,00 €

Monomando para lavabo, con caño giratorio.  
Wash basin mixer with swivel spout.



Cartucho Cartridge: 35000 (3750)

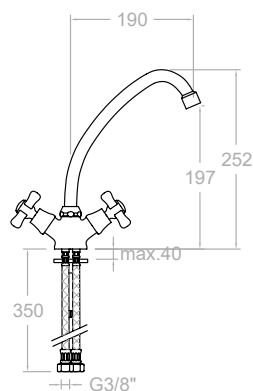

**3109C**  
261867

205,30 €

Bimando para fregadero con caño giratorio.  
Twin lever wall mounted sink mixer, with swivel spout.



Montura Head: 1700C1/2"

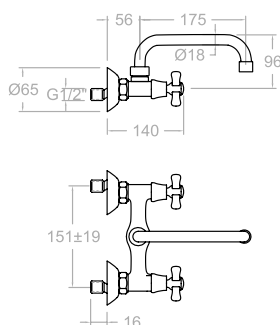

**3117C**  
300156

205,80 €

Bimando para fregadero mural, con caño giratorio.  
Twin lever sink mixer with swivel spout.



Montura Head: 1700C1/2"

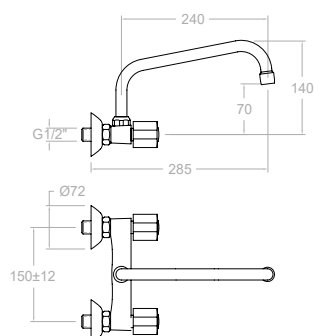

**7009CAI30E4**  
803287

99,90 €

Bimando para fregadero mural, con caño giratorio inclinado.  
Wall sink mixer sigh spout.



Montura Head: 5000

Breeam · Hoteles  
Breeam · Hotels



# Proyectos en todo el mundo

## Projects around the world

Las griferías y duchas de Ramon Soler han sido certificadas con las normativas más exigentes y sus redes comerciales se extienden a más de 40 países. Con numerosas referencias hoteleras internacionales, la firma está presente en cadenas hoteleras. Millones de usuarios utilizan diariamente nuestros productos, renovando día a día su confianza. Ramon Soler se encuentran en las instalaciones más importantes: cadenas hoteleras internacionales, grandes hospitales, transatlánticos, grandes yates, hoteles con encanto, promociones de prestigio e incluso en promociones pioneras y sensibles al ahorro de agua y al medio ambiente.

The faucets and showers of Ramon Soler have been certified with the most restrictive standards and its commercial networks span more than 40 countries. With numerous International hotel references, the firm is present in hotel chains.

Millions of consumers use our products every day, constantly confirming their confidence in us. Ramon Soler systems can be found at countless leading establishments: international hotel chains, large hospitals, ocean liners, super yachts, hotels with charm and even pioneering eco-friendly developments where water saving systems are installed.



SHERATÓN AIRPORT  
Frankfurt (Germany)

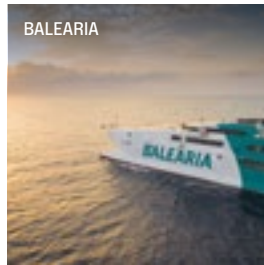

BALEARIA



POLICE HEADQUARTERS  
Frankfurt (Germany)

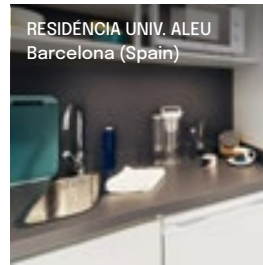

RESIDENCIA UNIV. ALEU  
Barcelona (Spain)



HOSPITAL ALGARVE  
Algarve (Portugal)

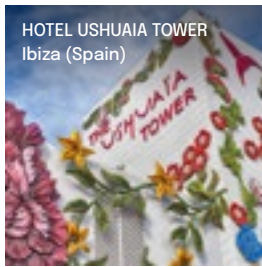

HOTEL USHUAIA TOWER  
Ibiza (Spain)

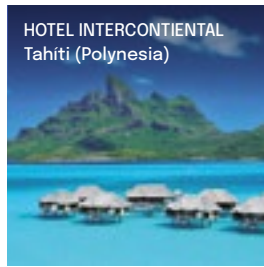

HOTEL INTERCONTIENTAL  
Tahiti (Polynesia)



HOTEL FERGUS  
Conil de la frontera (Spain)

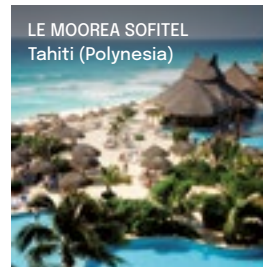

LE MOOREA SOFITEL  
Tahiti (Polynesia)

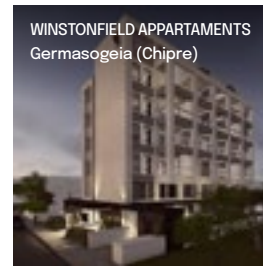

WINSTONFIELD APPARTAMENTS  
Germasogeia (Chipre)



HARD ROCK CAFE  
Ibiza (Spain)

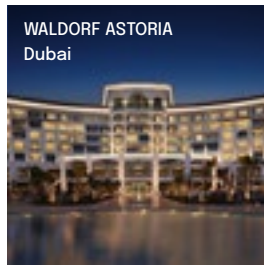

WALDORF ASTORIA  
Dubai

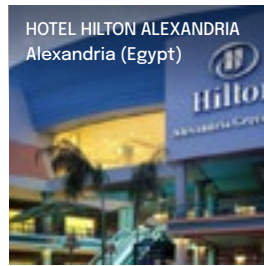

HOTEL HILTON ALEXANDRIA  
Alexandria (Egypt)

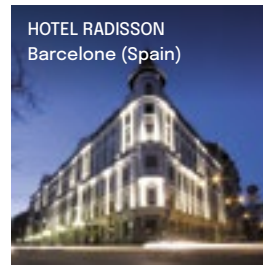

HOTEL RADISSON  
Barcelone (Spain)

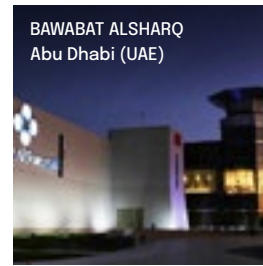

BAWABAT ALSHARQ  
Abu Dhabi (UAE)



HOTEL 2122  
Punta del Este

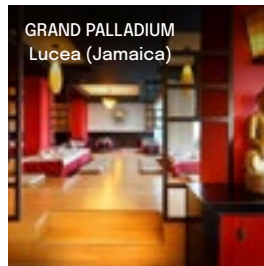

GRAND PALLADIUM  
Lucea (Jamaica)

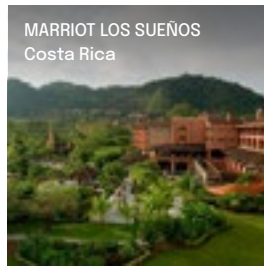

MARRIOT LOS SUEÑOS  
Costa Rica

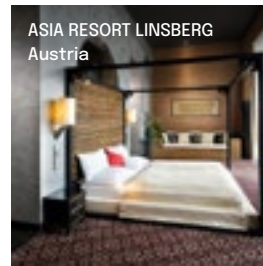

ASIA RESORT LINSBERG  
Austria



LE STADE DES LUMIÈRES  
Lyon (France)

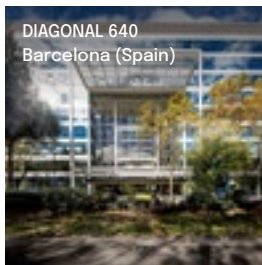

DIAGONAL 640  
Barcelona (Spain)

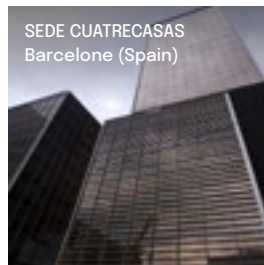

SEDE CUATRECASAS  
Barcelone (Spain)

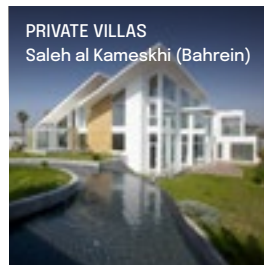

PRIVATE VILLAS  
Saleh al Kameskhi (Bahrein)

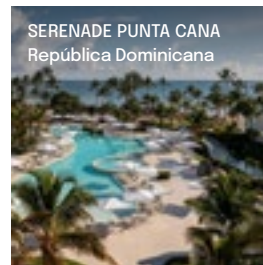

SERENADE PUNTA CANA  
República Dominicana

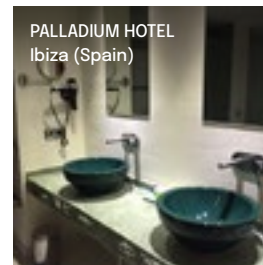

PALLADIUM HOTEL  
Ibiza (Spain)

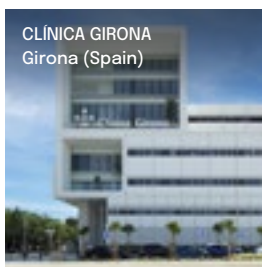

CLÍNICA GIRONA  
Girona (Spain)

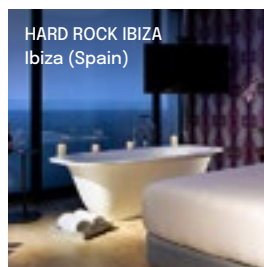

HARD ROCK IBIZA  
Ibiza (Spain)

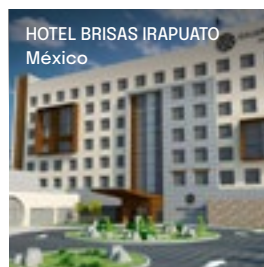

HOTEL BRISAS IRAPUATO  
México

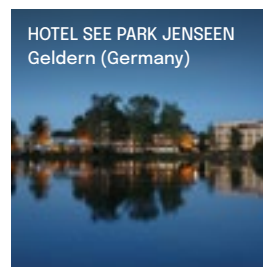

HOTEL SEE PARK JENSEN  
Geldern (Germany)



CITÉE INTERNATIONALE LYON  
Lyon (France)

# Grifería exclusiva para hoteles

Exclusive tapware for hotels

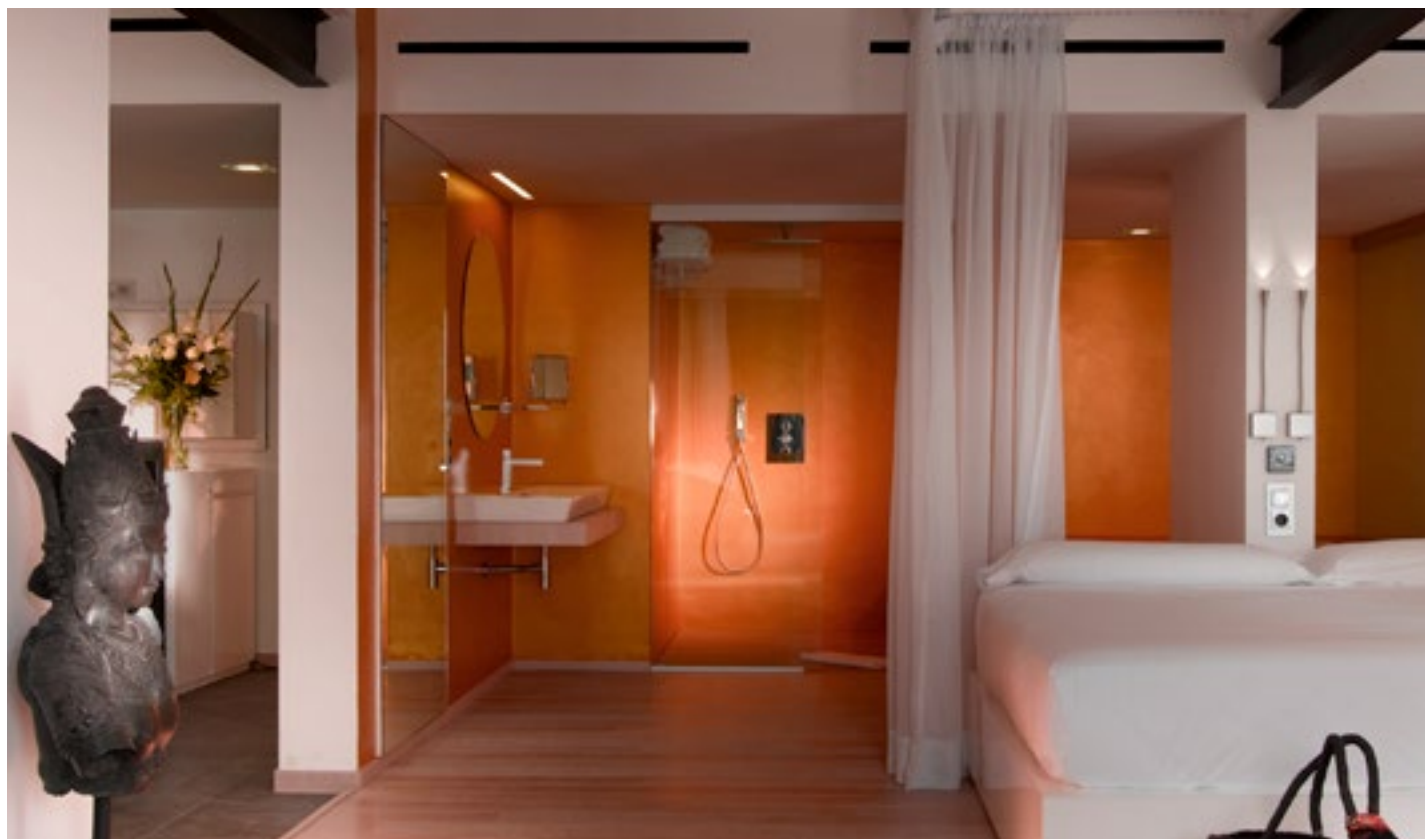

**ramonsoler.** es uno de los principales suministradores de la industria hotelera, que desde hace más de 25 años se supera día a día perfeccionando sus productos para sus específicas exigencias, tanto en ahorro de agua, como en seguridad, salud y pleno confort para las personas. Una buena grifería para HOTEL tiene que presentar no solo una estética depurada y de diseño, sino que también es necesario que reúna un conjunto de características técnicas que hagan de todo el conjunto una pieza idónea para proyectos del sector hotelero.

Las griferías de Ramon Soler® especialmente diseñadas para HOTELES están cuidadosamente creadas con una gran cantidad de ventajas, que beneficiarán tanto al huésped como al propietario del HOTEL.

**ramonsoler.** is one of the foremost suppliers of tapware for the hotel industry. For more than 25 years the daily needs of these clients have been covered, including water saving, security, health and comfort for the hotel guests. A good Hotel tapware not only enhances the aesthetic quality of the room but must also have a number of technical characteristics which make it ideal for this type of use.

Ramon Soler brassware has been especially designed for Hotels and takes into account the needs of both the guest and hotel chain.





SERENADE BEACH&SPA RESORT  
PUNTA CANA

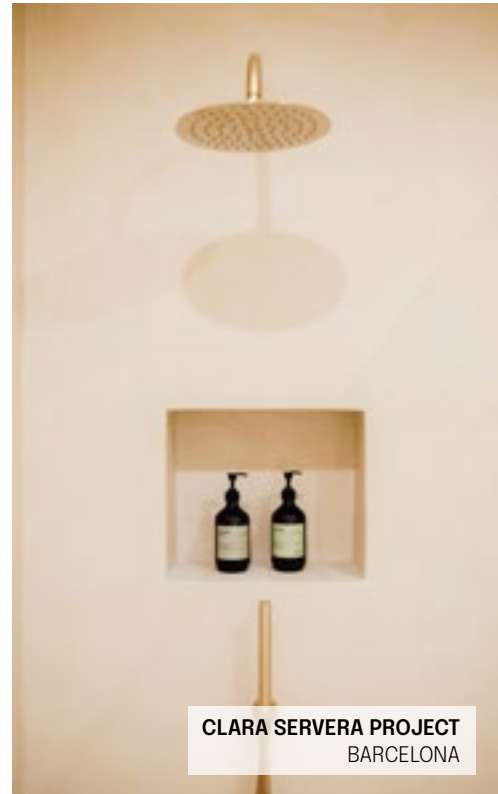

CLARA SERVERA PROJECT  
BARCELONA



HOTEL SHERATON  
FRANKFURT



HOTEL PEDRO I ARAGÓN  
HUESCA



NEVA TOWERS  
MOSCÚ



HOUSE BY SCENA INTERIORDSIGN  
ALEMANIA





# Hotel Premium

## Premium hotel

Momentos de relajación y confort entre altas dosis de diseño y espectacularidad. El Hotel Premium ha sido ideado para los clientes con gusto urbano y cosmopolita. Destaca por su amplio catálogo de series que aúnan diseño, calidad y tecnología.

Además, ofrece diseño sostenible en sus series de alta gama que han sido creadas bajo un principio de consumo responsable e integran sistemas de ahorro de agua y limitadores de caudal en sus componentes internos.

Moments of relaxation and comfort between high doses of design and beauty. Our premium series have been designed for customers with urban and cosmopolitan taste, and Ramon Soler® stands out for its wide range of series that combine design, quality and technology.

It offers sustainable design in its high-end series, which have been created under a principle of responsible water consumption and integration of water-saving systems in its internal components.



Adagio



Urban Chic



Alexia



Tzar



Arola



Kuatro



Kuatro NK



Ática



RS-Q



# Hotel con encanto

## Charming hotel

Cuando el cuidado por cada detalle y la calidad se encuentran en un hotel, su encanto es indiscutible. Encontrar elegancia y despertar sensaciones de serenidad en un hotel con encanto es un hecho, por su puesta en escena, su estilo sutil y su marcado carácter.

The beauty of a hotel is defined by its detail and features. A hotelier not only sells a room, but a series of sensations which clients look forward to, and these expectations must be fulfilled with a complete wellness programme.



Gaudi

# Hotel Medium

## Medium hotel



Drako      New fly      Ypsilon Plus

Las líneas básicas y el cuidado por el medio ambiente se respiran en el hotel MEDIUM. Ramon Soler® ofrece para estos espacios series de líneas sencillas que no renuncian a la calidad, completándolos con el carácter ecofriendly y económico que los caracterizan. Con Ramon Soler®, el hotel MEDIUM se viste de modernidad y funcionalidad

MEDIUM HOTEL are Ramon Soler basic lines, designed with simple lines bringing high quality, environmentally friendly and economic mixers for all the hotel industry.

With Ramon Soler®, MEDIUM hotel brings to the hotels modernity and functionality.



# Servicio y estudios personalizados de ahorro para hoteles

## Personalised hotel water efficiency studies

- Asesoramiento Técnico Pre-Venta. A petición del establecimiento hotelero nuestro equipo de análisis y estudios realizará un plan de gestión global para minimizar los costes en el suministro de agua.
- Servicio Post Venta y Calidad. La calidad de Ramon Soler va mucho más allá del ciclo de vida de un producto, cuando ese producto deja de fabricarse, sus recambios permanecen disponibles durante un período de diez años.
- Ofrecemos anualmente más de 2.000 productos que cumplen con los estándares de calidad y las normativas europeas más exigentes.

- We offer the possibility of evaluating the water use and saving which can be undertaken by implementing our systems in any hotel.
- Pre-sales and Post sales service and quality control.
- We currently offer more than 2,000 products which comply with the highest european quality standards.
- Ramon Soler's quality exceeds the life cycle of the product, as we maintain a ten year stock in spare parts.

## Cálculo Hotel

### Calculation

Cálculo ocupación media hoteles 175 habitaciones.  
Calculation average hotel occupancy 175 rooms.

HOTEL	
<b>Datos usuario</b> User data	<b>Variables</b>
Ocupación media (pax) Average occupancy (pax)	175
<b>Características grifería</b> Fittings features	<b>Variables</b>
Consumo lavado standard Standard wash consumption	10,00 L/min
Consumo ducha standard Standard shower consumption	15,00 L/min
Consumo lavado RS versión Hotel Sistema S2-C2 Consumption washing RS Hotel version S2-C2 System	3,75L/min
Consumo lavado RS versión Hotel Sistema C3 Consumption washing RS Hotel version C3 System	3,75L/min
Consumo ducha RS versión Hotel Sistema S2-C2 Shower consumption RS Hotel version S2-C2 System	6,00 L/min
<b>Hipótesis</b> Hypothesis	<b>Variables</b>
Tiempo ducha - media de uso Shower time - average use	7 minutos
Tiempo lavado/bidé - media uso Washing/bidet time - average use	3 minutos
Coste agua m3 - Zona - Valor medio estadístico Water cost m3 - average statistical value	1,39 €/m3
Coste KWh energía - Zona - Valor medio estadístico (Gas) KWh energy cost - statistical average value (Gas)	0,053 €/KWh
<b>Resultado</b> Results	<b>Variables</b>
Coste agua Cost of water	0,0014 €/L
Coste energía por litro agua caliente Energy cost per litre hot water	0,0033 €/L
Coste Energía + Agua Energy + Water Cost	0,0046 €/L
Coef. Usos K - según NF P 40-202 - DTU 60.11(*) Usage Coef. K - according to NF P 40-202 - DTU 60.11(*)	0,22
Consumo instantaneo Grifería estandar Instantaneous consumption Standard fittings	1222 L/min
Consumo instantaneo Grifería Ramon Soler versión Hotel Instantaneous consumption Ramon Soler faucet Hotel version	574 L/min
Consumo Grifería estandar Consumption Standard faucet	23.625L/día
Consumo Grifería Ramon Soler Consumption Ramon Soler faucet	11,769 L / día
Ahorro con Sistema S2-C2 Ramon Soler Savings with S2-C2 Ramon Soler System	-11,856 L / día
Ahorro con Sistema S2-C2 Ramon Soler Savings with S2-C2 Ramon Soler System	-50,2%
Ahorro medio energía [kWh/h/año] - norma UNE 94002:2005 Average energy savings [kWh/h/year] - UNE 94002:2005 Standard	-265.761 KWh/año
Ahorro económico lavabo y ducha sistema S2-C2 S2-C2 economic saving in washbasin and shower system	-20.101 €/año
Ahorro económico lavabo C3 y ducha S2-C2 Economical saving C3 basin and S2-C2 shower	-25.485 €/año

# Los grifos deben cumplir las siguientes características funcionales

## Mixers & Standards

La grifería sanitaria de Ramon Soler cumple con la más estricta normativa europea del sector, sobre la que realizamos ensayos en nuestros laboratorios que se encuentran técnicamente preparados para ello:

Los grifos o mezcladores mecánicos se ensayan conforme a la norma UNE-EN817:2009 y a la norma UNE 19703:2016.

Los grifos simples y los mezcladores cumplen con la norma UNE-EN 200:2008

Los materiales en contacto con el agua no han de constituir ningún peligro para la salud a una temperatura de 90° C. No deben producir alteración alguna en el agua a nivel cualitativo, de aspecto, de olor o del gusto. Los materiales susceptibles a la corrosión serán tratados para evitarla.

Los revestimientos y las superficies significativas de los productos deben cumplir la norma UNE-EN 248:2003.

Reguladores de chorro, conexiones flexibles, flexibles de ducha, mangos de ducha y rociadores, válvulas,... todos los productos pasan por un proceso de homologación interna en base a la normativa europea aplicable, garantizando tanto los niveles de calidad como la intercambiabilidad de los mismos.

Ramon Soler complies with the strictest European Standards in the sector. Our Quality Lab is technically prepared to conduct tests according such standards:

• Ramon Soler complies with the strictest European Standards in the sector. Our Quality Lab is technically prepared to conduct tests according such standards:

• Mixers are tested in accordance with UNE-EN817: 2009

• Mixers are tested in accordance with UNE-EN 200: 2008

• Materials in contact with water must not constitute a health hazard at a temperature of 90° C. They should not produce any alteration in water quality level, appearance, odor or taste. The materials used by Ramon Soler are hazardous free.

• Chromate process is tested in accordance with UNE-EN 248: 2003.

• Regulators jet, flexible connections, flexible shower, shower handles and sprinklers, valves, ... all products go through a process of internal approval based on the applicable European regulations, guaranteeing both the levels of quality and interchangeability same.

## Nuestro compromiso Our engagement

Ramon Soler, consciente de la importancia de la grifería no sólo en la higiene sino en el ahorro de agua y energía, se ha asociado con la organización European Water Label, con el objetivo de ofrecer una gama de productos eco eficientes, que respeten el medioambiente.

Todos los productos registrados en esta entidad se identifican con la siguiente etiqueta:

At Ramon Soler, we are not only aware of the importance of the tapware in hygiene but also in water saving and energy issues. This in turn has enabled us to become associated with the European Water Label organization, with the aim of offering a range of eco-efficient products that respect the environment .

All these registered products are identified with the following label:

### SIGNIFICADO DE LA ETIQUETA

Se muestra claramente el volumen máximo de agua, si el producto se ha instalado correctamente y de acuerdo con las instrucciones del fabricante

- Bandas de rendimiento de color
- La capacidad real / rendimiento



### LABEL DEFINITION

It clearly shows the maximum volume of water if the product has been installed correctly and according to the manufacturer's instructions

- Coloured performance bands
- Actual capacity/performance

# Características especiales

## Special features

LAVABO

MIXER



LIMITADOR Anti-retorno  
LIMITER Non-return

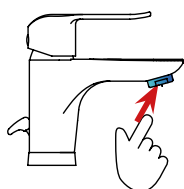

- Caudal standard: 12 l/min.
- Caudal reducido: 3,75 l/min
- AHORRO: 68 %
- Standard flow: 12 l/min.
- Flow limiter: 3,75 l/min
- SAVING: 68 %

1

### Sistema de ahorro de agua y energía C2/S2 o C3/S3

Water & energy saving systems C2/S2 o C3/S3



C2/S2. Apertura en dos fases, con un tope intermedio para obtener un ahorro de agua del 50%.

C2/S2. Step two-phase opening, with an intermediate stop for saving 50% of water.



C3/S3. Apertura escalonada en frío. Ahorro de agua y energía.

C3/S3 Gradual opening cold. water and energy saving.

2

### Aireadores. Limitadores de caudal

Aerators with flow limiter



Limitador de caudal de 3,5 l/min. Disponemos además de un amplio abanico de limitadores (1,7 l/min a 8 l/min.) adaptados a las necesidades del cliente.

Sistema de limitación NO removable, solo bajo control técnico.

Flow Limiter 3,5 L/min. We have also a wide range of limiters (1.7 l/min to 8 l/min ) according our customer needs.

NON-removable limitation system, only under technical control.

3

### Anodo de sacrificio

Sacrificial anode



Protegemos de la corrosión las superficies de la grifería con un ánodo de sacrificio de zinc-magnesio el cual se coloca en todas nuestras series, tanto en los anclajes verticales como en los murales, asimismo nuestras manetas estan también protegidas. Este sistema patentado por Ramon Soler triplica la vida de nuestros recubrimientos por corrosión externa.

In Ramon Soler we protect the surfaces of the faucet from corrosion with a zinc-magnesium sacrificial anode which is placed in all our series, both in vertical anchors and murals, our handles are also protected. This system patented by Ramon Soler triples the life of our external corrosion coatings.

#### OTRAS OPCIONES DE LIMITACIÓN DE CAUDAL

	REF	CAUDAL FLOW	AHORRO SAVING
Lavabos Mixers	1526	8 L/min	33 %
	1517	8 L/min	33 %
	1525	8 L/min	50 %
	1528	5 L/min	58 %
Standard	1527	3,5 L/min	68 %
Spray	1529	1,7 L/min	85 %

# LAVABO

## MIXER



LIMITADOR Anti-retorno  
LIMITER Non-return

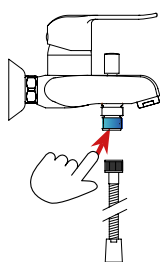

- Caudal standard: 15 l/min.
- Caudal reducido: 8l/min
- AHORRO: 45%
- Standard flow: 15 l/min.
- Flow limiter: 8l/min
- SAVING: 45 %

### 1

#### Sistema de ahorro de agua y energia S2

Water & energy saving systems S2



Ofrece una alta resistencia al uso frecuente y a los productos de limpieza.

have this piece in order to get strength and durability.

### 2

#### Limitador caudal con antiretorno 6 l/min ARD+C6

Flow limited with antiretorno 6 l/min ARD+C6



Limitador de caudal de 6 l/min. Disponemos además de un amplio abanico de limitadores (3 l/min a 8 l/min.) adaptados a las necesidades del cliente.

Flow Limiter 6 L/min. We have also a wide range of limiters (3 l /min to 8 l /min) according our customer needs.

### 3

#### Distribuidor metálico

Metal diverter



Ofrece una alta resistencia al uso frecuente y a los productos de limpieza.



It is highly resistant to frequent use and cleaning products.

### 4

#### Anodo de sacrificio

Sacrificial anode



Protegemos de la corrosión las superficies de la grifería con un ánodo de sacrificio de zinc-magnesio el cual se coloca en todas nuestras series, tanto en los anclajes verticales como en los murales, asimismo nuestras manetas estan también protegidas. Este sistema patentado por Ramon Soler triplica la vida de nuestros recubrimientos por corrosión externa.

In Ramon Soler we protect the surfaces of the faucet from corrosion with a zinc-magnesium sacrificial anode which is placed in all our series, both in vertical anchors and murals, our handles are also protected. This system patented by Ramon Soler triples the life of our external corrosion coatings.

#### OTRAS OPCIONES DE LIMITACIÓN DE CAUDAL

	REF	CAUDAL FLOW	AHORRO SAVING
Teleducha Handshower	JLC 10 	10 L/min	80 %
	JLC 8 	8 L/min	45 %
	JLC 6 	6 L/min	60 %
	JLC 3 	3 L/min	80 %
	ARD+C8 	8 L/min	45 %
Standard	ARD+C8 	8 L/min	60 %





**BRE3602** 197,30 € Caudal Flow 5 l/min  
36A305908

**BRE3602NM** 307,30 € Caudal Flow 5 l/min  
36A305909

**BREH3602** 197,30 € Caudal Flow 3,5 l/min  
36A305908

**BRE3H602NM** 307,30 € Caudal Flow 3,5 l/min  
36A305909

Monomando de lavabo (XL).  
High washbasin mixer (XL).



**BRE360302** 98,10 € Caudal Flow 5 l/min  
36B306985

**BREH360302** 98,10 € Caudal Flow 3,5 l/min  
36B306991

Monomando de bidé.  
Bidet mixer.



**BRE3604** 119,80 € Caudal Flow 5 l/min  
36A305904

**BRE3604NM** 186,60 € Caudal Flow 5 l/min  
36A305905

**BREH3604** 119,80 € Caudal Flow 3,5 l/min  
36A305904

**BREH3604NM** 186,60 € Caudal Flow 3,5 l/min  
36A305905

Monomando de lavabo (M).  
High washbasin mixer (M).



**BRE360403** 125,40 € Caudal Flow 5 l/min  
36A306986

**BRE360403NM** 191,30 € Caudal Flow 5 l/min  
36A306987

Monomando de lavabo, apertura en frío.  
Washbasin mixer, cold opening.



**BRE360602** 141,10 € Caudal Flow 5 l/min  
36E305899

Monomando para fregadero.  
Sink mixer.



**BRE3605S** 148,20 € Caudal Flow 8 l/min  
36C305903

**BRE360501SNM** 222,30 € Caudal Flow 8 l/min  
36C305901

**BREH3605S** 148,20 € Caudal Flow 6 l/min  
36C306999

**BREH360501SNM** 269,10 € Caudal Flow 6 l/min  
36C306997

Monomando de baño-ducha sin equipo de ducha.  
Bath and shower mixer without shower set.



**BRE3605T1** 194,30 € Caudal Flow 8 l/min  
36C305900  
BRE3605S+3520T1+3726M+2472C

**BREH3605T1** 194,30 € Caudal Flow 6 l/min  
36C307000  
BRE3605S+3520T1+3726M+2472C

Conjunto monomando de bañoducha con equipo de ducha.  
Bath and shower mixer with shower set.



**BRE360501BTNM** 378,90 € Caudal Flow 8 l/min  
36C305902  
BRE360501SNM+2876BTNM+372602NM+2475CNM

**BREH360501BTNM** 425,67 € Caudal Flow 6 l/min  
36C306998  
BRE360501SNM+2876BTNM+372602NM+2475CNM

Conjunto monomando de bañoducha con equipo de ducha.  
Bath and shower mixer with shower set.



**BRE3608S** 119,80 € Caudal Flow  
36D305898 8 l/min

**BRE360801SNM** 179,80 € Caudal Flow  
36D305895 8 l/min

**BREH3608S** 119,80 € Caudal Flow  
36D307003 6 l/min

**BREH360801SNM** 217,60 € Caudal Flow  
36D307001 6 l/min

Monomando de ducha sin equipo de ducha.

Shower mixer without shower set.



**BRE3608BTNM** 336,30 € Caudal Flow  
36D305896 8 l/min

BRE360801SNM+2876BTNM+372602NM+2475CNM

**BREH360801BTNM** 374,30 € Caudal Flow  
36D307002 6 l/min

BRE360801SNM+2876BTNM+372602NM+2475CNM

Conjunto monomando de ducha con equipo de ducha.

Shower mixer with shower set.



**BRE3608T1** 165,90 € Caudal Flow  
36D305897 8 l/min

BRE3608S+3520T1+3726M+2472C

**BREH3608T1** 165,90 € Caudal Flow  
36D307004 6 l/min

BRE3608S+3520T1+3726M+2472C

Conjunto monomando de ducha con equipo de ducha.

Shower mixer with shower set.



**BRE362103** 254,80 € Caudal Flow  
36A305893 5 l/min

**BRE362103NM** 396,80 € Caudal Flow  
36A305894 5 l/min

**BREH362103** 254,80 € Caudal Flow  
36A307005 3.5 l/min

**BREH362103NM** 396,80 € Caudal Flow  
36A307007 3.5 l/min

Monomando de lavabo empotrado mural con caño de 24 cm.

Concealed washbasin mixer with 24 cm spout.



**BRE3634S** 194,30 € Caudal Flow  
36C305900 8 l/min

BRE3605S+3520T1+3726M+2472C

**BREH3634S** 196,20€ Caudal Flow  
36D305892 6 l/min

BRE3605S+3520T1+3726M+2472C

Termostático de ducha, sin equipo de ducha.

Thermostatic shower mixer without shower set.



**BRE3634TR** 196,20€ Caudal Flow  
36D305891 8 l/min

BRE3634S+2877TR+3726M+2472C

Termostático de ducha, con equipo de ducha.

Thermostatic shower mixer, with shower set.



**BRE363901S** 264,50 € Caudal Flow  
36C305890 8 l/min

BRE363901S+2877TR+3726M+2472C

**BREH363901S** 264,50 € Caudal Flow  
36C307010 6 l/min

BRE363901S+2877TR+3726M+2472C

Termostático de baño- ducha salida cascada, sin equipo de ducha

Thermostatic bath shower mixer with cascade stream, without shower set.



**BRE363901TR** 369,30 € Caudal Flow  
36C305889 8 l/min

BRE363901S+2877TR+3726M+2472C

**BREH363901TR** 369,30 € Caudal Flow  
36C307011 6 l/min

BRE363901S+2877TR+3726M+2472C

Termostático de baño- ducha salida cascada, con equipo de ducha.

Bath tub thermostatic with cascade stream, with shower set.



**BRE3304** 114,80 € Caudal Flow 5 l/min  
33A307013

**BREH3304** 114,80 € Caudal Flow 3.5 l/min  
33A307024

Monomando de lavabo (M).  
Washbasin mixer.



**BRE3304VA1169** 135,20 € Caudal Flow 5 l/min  
33A307018

**BREH3304VA1169** 135,20 € Caudal Flow 3.5 l/min  
33A307028

Monomando de lavabo (M), con válvula automática 1/4". Ref. 1169.  
Washbasin mixer with stainless steel pop-up waste 1/4". Ref. 1169.



**BRE330403** 120,20 € Caudal Flow 5 l/min  
33A307016

**BREH330403** 120,20 € Caudal Flow 3.5 l/min  
33A307025

Monomando de lavabo, apertura en frío.  
Single lever washbasin, system C3 cold opening.



**BRE330403VA1169** 140,80 € Caudal Flow 5 l/min  
33A307017

**BREH330403VA1169** 140,80 € Caudal Flow 3.5 l/min  
33A307026

Monomando de lavabo con válvula automática de inox 1/4", ref. 1169.  
Washbasin mixer with stainless steel pop-up waste 1/4", ref. 1169.



**BRE330302** 114,80 € Caudal Flow 5 l/min  
33B307012

**BREH330302** 114,80 € Caudal Flow 3.5 l/min  
33B307023

Monomando para bidé.  
Bidet mixer.



**BRE3305S** 167,30 € Caudal Flow 8 l/min  
33C307019

**BREH3305S** 167,30 € Caudal Flow 8 l/min  
33C307029

Monomando de baño - ducha sin equipo de ducha.  
Bath and Shower mixer without shower set.



**BRE3305T3** 219,90 € Caudal Flow 8 l/min  
33C307020

**BREH3305T3** 219,90 € Caudal Flow 6 l/min  
33C307030

Monomando Baño-Ducha con equipo de ducha  
Bath and Shower mixer with shower set.



**BRE3308S** 132,70 € Caudal Flow 8 l/min  
33D307021

**BREH3308S** 132,70 € Caudal Flow 6 l/min  
33D307031

Monomando de ducha sin equipo de ducha.  
Shower mixer without shower set.



**BRE3308T3** 185,20 € Caudal Flow 8l/min  
33D307022

**BREH3308T3** 185,20 € Caudal Flow 6l/min  
33D307032

Monomando de ducha con equipo de ducha.  
Shower mixer with shower set.



**BRE570113** 71,80 € Caudal Flow 5l/min  
57A305885

**BREH570113** 71,70 € Caudal Flow 3.5l/min  
57A307048

Monomando de lavabo con apertura en frío.  
Washbasin mixer, cold opening.



**BRE570111** 71,80 € Caudal Flow 5l/min  
57A305887

**BRE570111NM** 110,30 € Caudal Flow 5l/min  
57A305886

**BREH570111** 71,80 € Caudal Flow 3.5l/min  
57A307046

**BREH570111NM** 110,30 € Caudal Flow 3.5l/min  
55A307047

Monomando de lavabo.  
Washbasin mixer.



**BRE570311** 70,50 € Caudal Flow 5l/min  
57B307034

**BREH570311** 70,50 € Caudal Flow 3.5l/min  
57B307049

Monomando de bidé.  
Bidet mixer.



**BRE570502S** 100,30 € Caudal Flow 8l/min  
57C305883

**BRE570502SNM** 180,60 € Caudal Flow 8l/min  
57C305888

**BREH570502S** 100,30 € Caudal Flow 6l/min  
57C307052

**BREH570502SNM** 180,60 € Caudal Flow 6l/min  
57C307054

Monomando de baño-ducha sin equipo de ducha.  
Bath and shower mixer without shower kit.



**BRE570502BTNM** 312,00 € Caudal Flow 8l/min  
57C305884

BRE570502SNM+2876BTN-M+372602NM+2475CNM

**BREH570502BTNM** 312,00 € Caudal Flow 6l/min  
57C307050

BRE570502SNM+2876BTN-M+372602NM+2475CNM

Monomando de Baño-Ducha con equipo de ducha.  
Bath and shower mixer with shower set.



**BRE570502T1** 146,40 € Caudal Flow 8l/min  
57C305882

BRE570502S+3520T1+3726+1128C

**BREH570502T1** 146,40 € Caudal Flow 6l/min  
57C307057

BRE570502S+3520T1+3726+1128C

Monomando de Baño-Ducha con equipo de ducha.  
Bath and shower mixer with shower set.



**BRE570802S** 79,70 € Caudal Flow 8l/min  
57D305879 ●

**BRE570802SNM** 144,80 € Caudal Flow 8l/min  
57D307035 ●

**BREH570802S** 79,70 € Caudal Flow 6l/min  
57D307059 ●

**BREH570802SNM** 144,80 € Caudal Flow 6l/min  
57D307061 ●

**Monomando de baño-ducha sin equipo de ducha.**

Bath and shower mixer without shower kit.



**BRE570802BTNM** 276,40 € Caudal Flow 8l/min  
57D305880 ●

BRE570802SNM+2876BTN-M+372602NM+2475CNM

**BREH570802BTNM** 276,40 € Caudal Flow 6l/min  
57D307058 ●

BRE570802SNM+2876BTN-M+372602NM+2475CNM

**Monomando de baño-ducha con equipo de ducha.**

Bath and shower mixer with shower set.



**BRE570802T1** 125,80 € Caudal Flow 8l/min  
57D305910 ●  
BRE570802S+3520T1+3726+1128C

**BREH570802T1** 125,80 € Caudal Flow 6l/min  
57D307062 ●  
BRE570802S+3520T1+3726+1128C

**Monomando de baño-ducha con equipo de ducha.**

Bath and shower mixer with shower set.



**BRE570611** 108,90 € Caudal Flow 5l/min  
57E305881 ●

**Monomando de fregadero con caño alto giratorio.**

Sink mixer with swivel high spout.



<b>BRE571011</b> 57A307036	152,60 €	Caudal Flow 5l/min
<b>BRE571011NM</b> 57A307037	228,80 €	Caudal Flow 5l/min
<b>BREH571011</b> 57A307063	152,60 €	Caudal Flow 5l/min
<b>BREH571011NM</b> 57A307064	228,80 €	Caudal Flow 5l/min

Monomando de lavabo (L).  
Washbasin mixer (L).



<b>BRE932802S</b> 94D305876	197,10 €	Caudal Flow 5l/min
<b>BRE932802SNM</b> 94D305877	345,10 €	Caudal Flow 5l/min

Grifería monomando de gran ducha e inversor integrado.  
Single lever with integrated diverter.



<b>BRE937413RP300</b> 94D305874	444,80 €	Caudal Flow 5l/min
------------------------------------	----------	-----------------------

Conjunto monomando gran ducha.  
Single lever shower mixer.



<b>BRE937412RP300NM</b> 94D305875	666,40 €	Caudal Flow 5l/min
--------------------------------------	----------	-----------------------

Conjunto monomando gran ducha.  
Single lever shower mixer.



<b>BRE941202S</b> 94D305867	232,20 €	Caudal Flow 5l/min
<b>BRE941202SNM</b> 94D305868	348,20 €	Caudal Flow 5l/min

Grifería termostática.  
Thermostatic shower.



<b>BRE943402S</b> 94D305866	159,80 €	Caudal Flow 5l/min
--------------------------------	----------	-----------------------

Ducha termostática.  
Thermostatic shower.



<b>BRE941502RP240</b> 94D305864	308,40 €	Caudal Flow 8l/min
<b>BRE941502RP240NM</b> 94D305865	462,50 €	Caudal Flow 8l/min

Conjunto monomando empotrado 2 vías.  
Concealed wall single lever 2 way.



<b>BRE941502RK250</b> 94D305866	437,30 €	Caudal Flow 8l/min
------------------------------------	----------	-----------------------

Accesorios de metal 250x250 mm..  
Metall accessories 250x250 mm..







**BRE943402T1** 212,40 € Caudal Flow  
 94D305861  
 BRE943402S+3520T1+3726+2471C ● 8l/min

Termostático de baño - ducha con inversor integrado, con equipo de ducha.  
 Bathtub thermostatic with a shower set.



**BRE943801S** 209,50 € Caudal Flow  
 94C305860 ● 8l/min

Termostático de baño - ducha, sin equipo de ducha.  
 Bathtub thermostatic without shower kit.



**BRE943801T1** 255,60 € Caudal Flow  
 94C305859  
 BRE943801S+3520T1+3726+2471C ● 8l/min

Termostático de baño - ducha con inversor integrado, con equipo de ducha.  
 Bathtub thermostatic with a shower set.



**BRE943901S** 243,90 € Caudal Flow  
 94C306973 ● 8l/min

Termostático de baño - ducha con cascada e inversor integrado, sin equipo de ducha.  
 Bathtub thermostatic with cascade stream, without shower kit.



**BRE943901T1** 289,90 € Caudal Flow  
 94C306962  
 BRE943901S+3520T1+3726+2471C ● 8l/min

Termostático de baño - ducha con cascada e inversor integrado, con equipo de ducha.  
 Bathtub thermostatic with cascade stream, with a shower set.



**BRE945412RP300** 543,70 € Caudal Flow  
 94D305855  
 BRE941202S+BREDN130D+RP300+2876BT+2478C ● 8l/min

**BRE945412RP300NM** 815,50 € Caudal Flow  
 94D305856  
 BRE941202SNM+DN130DNM+RP300NM+2876BTNM+2475CNM ● 8l/min

Conjunto termostático gran ducha con columna telescópica, accesorios ABS.  
 Thermostatic telescopic shower column, ABS accessories.



**BRE948712RP240** 441,80 € Caudal Flow  
 94D305853  
 BRE948712S+BRE350+RP240+2876BT+BRE3796+2471 ● 8l/min

**BRE948712RP240NM** 662,70 € Caudal Flow  
 94D305854  
 BRE948712S NM+BRE350NM+BRE3796NM+2475CNM ● 8l/min

Conjunto termostático empotrado 2 vías.  
 Thermostatic single lever 2 ways.



**BRE948712RPK225** 467,70 € Caudal Flow  
 94D305846  
 948712KS+BRE350+RPK225+4713P+BRE4796+2471 ● 8l/min

Conjunto termostático empotrado 2 vías.  
 Thermostatic single lever 2 ways.





**BRE963402S** 157,00 €  
96D306976

Caudal  
Flow  
8 l/min

**Termostático de ducha con equipo de ducha.**  
Thermostatic shower mixer with shower set.



**BRE963402T1** 191,60 €  
96D306965

Caudal  
Flow

BRE963402S+3520T1+3547+1128C

8 l/min

**Termostático de ducha sin equipo de ducha.**  
Thermostatic shower mixer without shower set.



**BRE963402BT** 195,50 €  
96D307065

Caudal  
Flow

BRE963402S+2876BT+3726+1128C

8 l/min

**Termostático de baño-ducha con equipo de ducha.**  
Thermostatic bath and shower mixer with shower set.



**BRE963901S** 207,50 €  
96C306974

Caudal  
Flow

**Termostático de baño-ducha.**  
Thermostatic bath and shower mixer without shower set.



**BRE963901NL** 251,20 €  
96C306966

Caudal  
Flow

BRE963901S+3521NL+3547+1128C

5 l/min

**Termostático de baño-ducha con equipo de ducha.**  
Thermostatic bath and shower mixer with shower set.



**BRE180102** 49,50 €  
18A306739

Caudal  
Flow  
5 l/min

**BREH180102** 49,50 €  
18A306968

Caudal  
Flow  
3,5 l/min

**Monomando de lavabo.**  
Washbasin mixer.



**BRE180102VA9065** 60,10 €  
18A307066

Caudal  
Flow  
5 l/min

**BREH180102VA9065** 60,10 €  
18A307068

Caudal  
Flow  
3,5 l/min

**Monomando de lavabo, con válvula automática 1/4". Ref. 9065 ABS.**  
Washbasin mixer with pop-up waste 1/4". Ref. 9065 ABS.



**BRE180302** 51,20 € Caudal Flow 5l/min  
18B307067

**BREH180302** 51,20 € Caudal Flow 3.5l/min  
18B306969

Monomando de bidé.  
Bidet mixer.



**BRE1805S** 74,80 € Caudal Flow 8l/min  
18A306739

**BREH1805S** 74,80 € Caudal Flow 6l/min  
18C307069

Monomando de baño- ducha sin equipo de ducha.  
Bath and shower mixer without shower kit.



**BRE1805VM2** 99,00 € Caudal Flow 8l/min  
18C305917

**BREH1805VM2** 99,00 € Caudal Flow 6l/min  
18C307071  
BRE1805S+351502+3544+1128C

Monomando baño- ducha, con equipo de ducha.  
Bath and shower mixer with shower set.



**BRE1808S** 58,60 € Caudal Flow 8l/min  
18D305916

**BREH1808S** 58,60 € Caudal Flow 6l/min  
18D306971

Monomando ducha sin equipo de ducha.  
Shower mixer with out shower set.



**BRE1808VM2** 82,80 € Caudal Flow 8l/min  
18D306740  
BRE1808S+351502+3544+1128C

**BREH1808VM2** 82,80 € Caudal Flow 6l/min  
18D306972  
BRE1808S+351502+3544+1128C

Monomando ducha, con equipo de ducha.  
Shower mixer with shower set.



**BRE1836** 92,90 € Caudal Flow 5l/min  
18E305914

Monomando de fregadero con caño giratorio.  
Sink mixer with swivel spout.



**BREH1809** 62,30 € Caudal Flow 5l/min  
18E307073

Monomando de fregadero con caño giratorio conformado.  
Sink mixer with swivel spout.



**BREB350** 55,60 € Caudal Flow 8l/min  
99Z306738

**BREB350NM** 100,40 € Caudal Flow 8l/min  
99Z306742

Brazo de pared 350 mm.  
Shower arm 350 mm.



**BRE187402RP240** 357,50 € Caudal Flow  
18D305913  
BRE1838 S+DN132+IDH1/2+ RP240 +2876BT+1125C ● 8 l/min

**BRE187802RP230** 330,80 € Caudal Flow  
18D305912  
BRE1838S+T101+IDH1/2+RP230 +3525P1+1125C ● 8 l/min

Columna de ducha telescópica monomando con rociador Ø 240 mm.  
Single lever telescopic shower column with headshower Ø 240 mm.



**BREH180602** 74,20 € Caudal Flow  
18E307072 ● 5 l/min

Monomando para fregadero vertical con caño cisne.  
Sink mixer with swivel spout.



**BRE189102** 59,90 € Caudal Flow  
18A305911 ● 5 l/min

**BREH189102** 59,90 € Caudal Flow  
18A307075 ● 3.5 l/min

Monomando de lavabo, apertura en frío.  
Washbasin mixer, cold opening.



**BRE189102VA9065** 70,50 € Caudal Flow  
18A307074 ● 5 l/min

**BREH189102VA9065** 70,50 € Caudal Flow  
18A307076 ● 3.5 l/min

Monomando de lavabo, apertura en frío con válvula automática 1/4".  
Washbasin mixer cold opening with pop-up waste 1/4".



**BRE3796** 49,80 € Caudal Flow  
99Z306744 ● 8 l/min

**BRE3796NM** 89,70 € Caudal Flow  
99Z306745 ● 8 l/min

Codo de salida de agua y soporte fijo redondo.  
Water outlet elbow.



**BRE4796** 62,30 € Caudal Flow  
99Z306743 ● 8 l/min

Codo de salida de agua y soporte fijo cuadrado, antiretorno.  
Water outlet elbow.



**BREHCLET24** 61,30 € Caudal Flow  
AAZ307340 ● 3.5 l/min

**BREHCLET24NM** 108,40 € Caudal Flow  
AAZ307338 ● 3.5 l/min

Caño para lavabo empotrado de 24 cm.  
Washbasin concealed spout, 24 cm.



**BRECLET24** 61,30 € Caudal Flow  
AAZ306746 ● 5 l/min

**BRECLET24NM** 108,40 € Caudal Flow  
AAZ306741 ● 5 l/min

Caño para lavabo empotrado de 24 cm.  
Washbasin concealed spout, 24 cm.

# Colectividades

## Colectivities

ramonsoler.







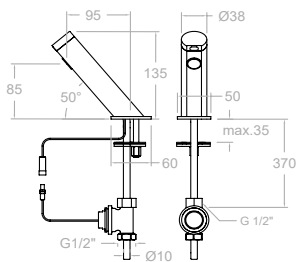

Caudal l/M Flow	6 l/min
Temperature	65°
Presión Pressure	1-5 bar (3 recom)

**8119B**

81A301495

341,50 €

Lavabo electrónico de un agua (o premezclada). Fuente de alimentación: batería alcalina 9V. Pilas no incluidas. Protección sanitaria: descarga automática anti-legionela cada 24h. Distancia de detención: 10 cm. Regulable con mando a distancia.

Electronic 1-water wash basin (or premixed). Power Supply: alkaline battery 9V. Batteries not included. Health protection: automatic anti-legionella discharge every 24 hours. Detention distance: 10 cm. Dimmable with remote control.



**8119TB**

81A301496

354,30 €

Lavabo electrónico de un agua (o premezclada). Fuente de alimentación: transformador más baterías 9V. Pilas no incluidas.

Electronic 1-water wash basin (or premixed). Power source: transformer plus 9V batteries. Batteries not included.

**MD01**

AAZ301995

191,30 €

Opcional. Mando a distancia.  
Optional. Remote control.

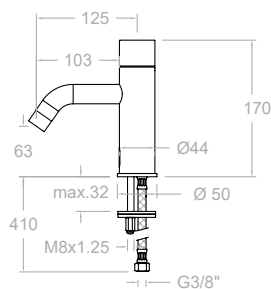

Caudal l/M Flow	6 l/min
Temperature	65°
Presión Pressure	1-5 bar (3 recom)

**8116B**

81A301490

463,80 €

Lavabo electrónico de un agua (o premezclada). Fuente de alimentación: batería alcalina 9V. Pilas no incluidas. Protección sanitaria: descarga automática anti-legionela cada 24h. Distancia de detención: 15 cm. No regulable.

Electronic 1-water wash basin (or premixed). Power Supply: alkaline battery 9V. Batteries not included. Health protection: automatic anti-legionella discharge every 24 hours. Detention distance: 15 cm. Not adjustable.



**8116TB**

81A301491

487,20 €

Lavabo electrónico de un agua (o premezclada). Fuente de alimentación: transformador más baterías 9V. Pilas no incluidas.

Electronic 1-water wash basin (or premixed). Power source: transformer plus 9V batteries. Batteries not included.

**MD01**

AAZ301995

191,30 €

Opcional. Mando a distancia.  
Optional. Remote control.

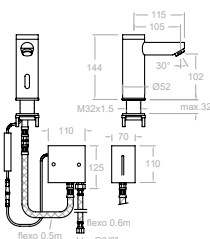

Timing	15 ± 5 seg
Caudal l/M Flow	6 l/min
Temperature	40°
Presión Pressure	1-5 bar (3 recom)

**8102**

231315

315,60 €

Lavabo electrónico de un agua (o premezclada). Fuente de alimentación: baterías alcalinas 4x1,5V o transformador 6V. NPilas no incluidas. Protección sanitaria: descarga automática anti-legionela cada 24h. Distancia de detención: 20 cm. Regulable. Instalación: Requiere agua libre de impurezas.

Electronic 1-water wash basin (or premixed) Power Supply: alkaline batteries 4x1,5V or transformer 6V. Batteries not included. Health protection: automatic anti-legionella discharge every 24 hours. Detention distance: 20 cm. Adjustable. Installation: Requires water free of impurities.



**3794\***

AAZ301450

18,10 €

Llave de paso con filtro.  
Stopcock with filter.

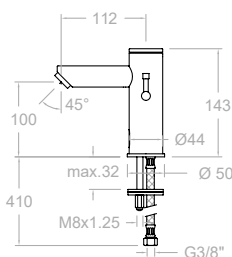

Caudal l/M Flow	6 l/min
Temperature	65°
Presión Pressure	1-5 bar (3 recom)

**8115B**

81A301488

463,80 €

Lavabo electrónico de 2 aguas (fría y caliente). Fuente de alimentación: batería alcalina 9V. Pilas no incluidas. Protección sanitaria: descarga automática anti-legionela cada 24h. Distancia de detención: 15 cm. Regulable con mando a distancia.

Electronic 2-water washbasin (cold and hot). Power Supply: alkaline battery 9V. Batteries not included. Health protection: automatic anti-legionella discharge every 24 hours. Detention distance: 15 cm. Dimmable with remote control.



**8115TB**

81A301489

487,20 €

Lavabo electrónico de 2 aguas (fría y caliente). Fuente de alimentación: transformador más baterías 9V. Pilas no incluidas.

Electronic 2-water washbasin (cold and hot). Power source: transformer plus 9V batteries. Batteries not included.

**MD01**

AAZ301995

191,30 €

Opcional. Mando a distancia.  
Optional. Remote control.

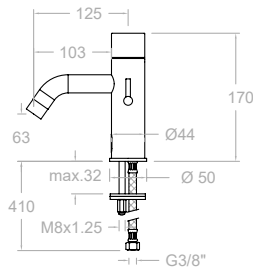

Caudal l/M Flow	6 l/min
Temperature	65°
Presión Pressure	1-5 bar (3 recom)

**8118B**

81A301492

502,60 €

Lavabo electrónico de 2 aguas (fría y caliente). Fuente de alimentación: batería alcalina 9V. Pilas no incluidas. Protección sanitaria: descarga automática anti-legionela cada 24h. Distancia de detención: 14 cm.

Electronic 2-water wash basin (cold and hot). Power Supply: alkaline battery 9V. Batteries not included. Health protection: automatic anti-legionella discharge every 24 hours. Detention distance: 14 cm.



**8118TB**

81A301493

525,80 €

Lavabo electrónico de 2 aguas (fría y caliente). Fuente de alimentación: transformador más baterías 9V. Pilas no incluidas.

Electronic 2-water washbasin (cold and hot). Power source: transformer plus 9V batteries. Batteries not included.

**MD01**

AAZ301995

191,30 €

Opcional. Mando a distancia.  
Optional. Remote control.



Caudal l/M Flow	6 l/min
Temperature	65°
Presión Pressure	1-5 bar (3 recom)

**8120B**

81A301497

546,40 €

Lavabo electrónico empotrado de un agua (o premezclada). Fuente de alimentación: batería alcalina 9V. Pilas no incluidas. Protección sanitaria: descarga automática anti-legionela cada 24h. Distancia de detención: 8 cm.

Concealed electronic 1-water wash basin (or premixed). Power Supply: alkaline battery 9V. Batteries not included. Health protection: automatic anti-legionella discharge every 24 hours. Detention distance: 8 cm.



**8120TB**

81A301499

569,50 €

Lavabo electrónico empotrado de un agua (o premezclada). Fuente de alimentación: transformador más baterías 9V. Pilas no incluidas.

Power source: transformer plus 9V batteries. Batteries not included.

**MD01**

AAZ301995

191,30 €

Opcional. Mando a distancia.  
Optional. Remote control.

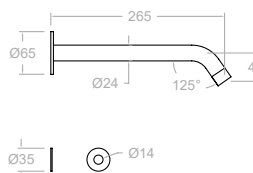

Caudal l/M Flow	6 l/min
Temperature	65°
Presión Pressure	1-5 bar (3 recom)

**8121B**

81A301500

463,80 €

Lavabo electrónico empotrado de un agua (o premezclada). Fuente de alimentación: batería alcalina 9V. Pilas no incluidas. Protección sanitaria: descarga automática anti-legionela cada 24h.

Concealed electronic 1-water wash basin (or premixed). Power Supply: alkaline battery 9V. Batteries not included. Health protection: automatic anti-legionella discharge every 24 hours.



**8121TB**

81A301501

476,60 €

Lavabo electrónico empotrado de un agua (o premezclada). Fuente de alimentación: transformador más baterías 9V. Pilas no incluidas.

Power source: transformer plus 9V batteries. Batteries not included.

**MD01**

AAZ301995

191,30 €

Opcional. Mando a distancia.  
Optional. Remote control.

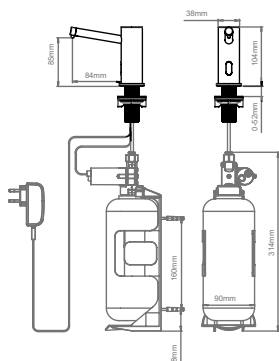

**8130B**

81Z301762

341,50 €

Instalación: Encimera  
Dosis de jabón predeterminada: 1,4 cc  
Lavatory mounted  
Default soap dosage: 1.4 cc

Fuente de alimentación: Pilas 12V  
Viscosidad del jabón: 100-3800 cPs  
Power source: 12 V transformer  
Soap viscosity: 100-3800 cPs



**MD01**

AAZ301995

191,30 €

Opcional. Mando a distancia.  
Optional. Remote control.

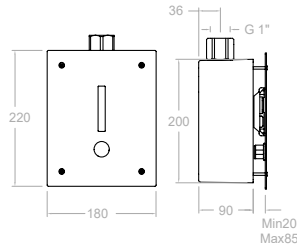

Timing	6 seg
Caudal l/M Flow	12 l/min
Temperature	65°
Presión Pressure	1-5 bar (3 recom)

**8124B**

81F301505

682,90 €

WC empotrado electrónico Fuente de alimentación: batería alcalina 9V. Pilas no incluidas. Protección sanitaria: descarga automática anti-legionela cada 24h. Distancia de detención: 40 cm.

Power Supply: alkaline battery 9V. Batteries not included. Health protection: automatic anti-legionella discharge every 24 hours. Detention distance: 40 cm.



**8124TB**

81F301506

706,20 €

WC empotrado electrónico. Fuente de alimentación: transformador más baterías 9V. Pilas no incluidas.

Power source: transformer plus 9V batteries. Batteries not included.

**MD01**

AAZ301995

191,30 €

Opcional. Mando a distancia. Optional. Remote control.

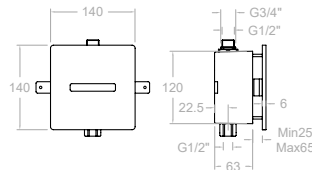

Timing	6 seg
Caudal l/M Flow	20 l/min
Temperature	65°
Presión Pressure	1-5 bar (3 recom)

**8122B**

81F301502

489,80 €

Urinario empotrado electrónico Fuente de alimentación: batería alcalina 9V. Pilas no incluidas. Protección sanitaria: descarga automática anti-legionela cada 24h. Presión de funcionamiento: 1-5 bar, recomendable 3 bar Distancia de detención: 40 cm.

Power Supply: alkaline battery 9V. Batteries not included. Health protection: automatic anti-legionella discharge every 24 hours Detention distance: 40 cm.



**8122TB**

81F301503

512,80 €

Urinario empotrado electrónico. Fuente de alimentación: transformador más baterías 9V. Pilas no incluidas.

Power source: transformer plus 9V batteries. Batteries not included.

**MD01**

AAZ301995

191,30 €

Opcional. Mando a distancia. Optional. Remote control.

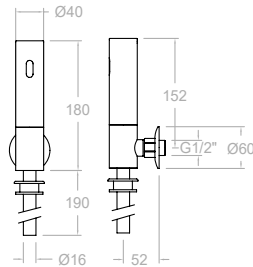

Timing	6 seg
Caudal l/M Flow	12 l/min
Temperature	65°
Presión Pressure	1-5 bar (3 recom)

**8123**

81F301504

418,70 €

Urinario mural electrónico Fuente de alimentación: batería alcalina 9V. Pilas no incluidas. Protección sanitaria: descarga automática anti-legionela cada 24h. Distancia de detención: 40 cm.

Health protection: automatic anti-legionella discharge every 24 hours for 6 seconds Detention distance: 40 cm.



**MD01**

AAZ301995

191,30 €

Opcional. Mando a distancia. Optional. Remote control.



**MD01**

AAZ301995

191,30 €

Permite el ajuste de distintas funciones

El cambio de cualquier definición afecta el funcionamiento del sistema por lo cual este control remoto debe ser utilizado solamente por personal autorizado. Para operar las funciones del control remoto, ud. Deberá tener productos cuyos modelos sean compatibles.

Cualquier ajuste que sea haga será guardado en la memoria de la unidad electrónica del grifo incluso si hay un corte de energía o desgaste en las baterías.

Allows adjustment of various functions

Changing any definition affects the operation of the system so this remote control should only be used by authorized personnel.

To operate the remote control functions, you. You must have products whose models are compatible.

Any adjustments made will be saved in the memory of the electronic faucet unit even if there is a power outage or battery wear.



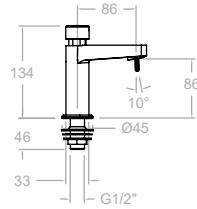

* Tiempo Timing	5 seg
Caudal l/M Flow	6 l/min
Descarga total Waterflow discharge	0,45 l

Cartucho Cartridge: 740103

* <b>745103</b>	61,90 €	
74A303248		
<b>BRES745103</b>	1,75 l/min	65,00 €
74A306458		

Lavabo recto temporizado de 1 agua con regulación de caudal.  
Straight timed 1 water washbasin with flow regulation.

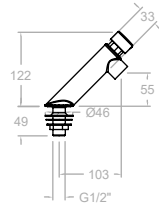

* Tiempo Timing	5 seg
Caudal l/M Flow	6 l/min
Descarga total Waterflow discharge	0,5 l

Cartucho Cartridge: 740103

* <b>745803</b>	55,60 €	
74A303247		
<b>BRES745803</b>	1,75 l/min	58,40 €
74A306459		

Lavabo inclinado temporizado 1 agua con regulación tiempo/  
caudal.  
Tilted timed 1 water washbasin with time and flow regulation.

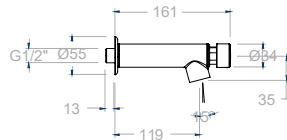

* Tiempo Timing	5 seg
Caudal l/M Flow	6 l/min
Descarga total Waterflow discharge	0,5 l

Cartucho Cartridge: 740103

* <b>745203</b>	54,40 €	
74A303249		
<b>BRES745203</b>	1,75 l/min	57,10 €
74A306460		

Lavabo inclinado temporizado 1 agua con regulación tiempo/  
caudal.  
Wall timed 1 water washbasin with time and flow regulation.

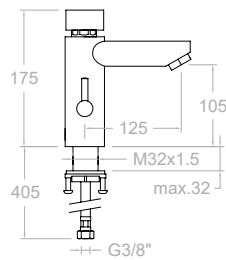

Cartucho Cartridge: 7408

<b>7490</b>	188,00 €	
239595		

Lavabo temporizado mezclador (fría y caliente).  
Self closing wash basin mixer (cold and hot).

Tiempo Timing	5 seg
Caudal l/M Flow	6 l/min
Descarga total Waterflow discharge	0,5 l
Bar	1-5 (3 recom)

Disponible en mayo  
Available to May

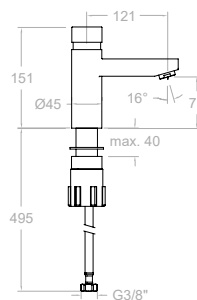

<b>749002</b>	188,00 €	
74A308049		

Lavabo temporizado mezclador (fría y caliente).  
Self closing wash basin mixer (cold and hot).

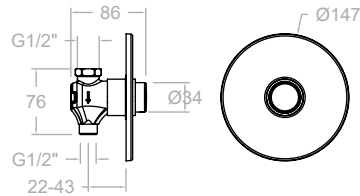

Cartucho Cartridge: 740203

**745503**  
74D303252

57,30 €



Ducha empotrada temporizada de 1 agua con florón Ø147 mm.  
Concealed timed 1 water shower with escutcheon Ø147 mm.

Tiempo Timing	22 seg
Caudal l/M Flow	9 l/min
Descarga total Waterflow discharge	3,3 l

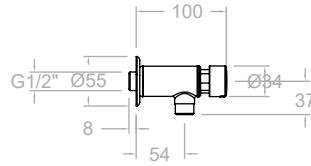

Cartucho Cartridge: 740203

**745303**  
74F303250

41,90 €



Urinario visto temporizado de 1 agua.  
Self closing urinal 1 water.

Tiempo Timing	5 seg
Caudal l/M Flow	6,5 l/min
Descarga total Waterflow discharge	0,55 l

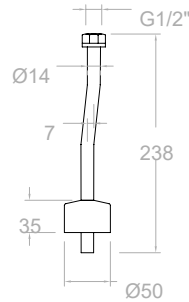

**755**  
500737

14,20 €

Enlace para urinario de 1/2" x Ø14x radio 7 mm para 7453.  
Urinal flushing pipe 1/2" x Ø14x 240mm y radius 7 mm for 7453.

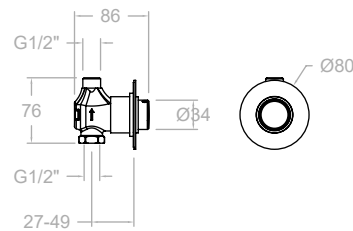

Cartucho Cartridge: 740203

**745903**  
74F303585

54,30 €



Urinario empotrado temporizado de 1 agua, con florón Ø80 mm.  
Self closing urinal 1 water, with rosette Ø80 mm.

Tiempo Timing	9 seg
Caudal l/M Flow	10 l/min
Descarga total Waterflow discharge	1,5 l

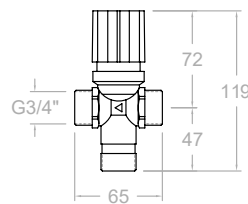

**733**  
501157

173,10 €



Válvula mezcladora con válvula antiretorno. Ajuste premezclador de temperatura entre 25 °C y 60 °C, caudal máximo a 30 l/min a 3 bar suministros de 1 a 5 en lavabo o de 1 a 3 en duchas.

Simple thermostatic tap anti-return valves. Premixing temperature adjustment between 25 °C and 60 °C, maximum flow of 30 l/min at 3 bar supplies from 1 to 5toilets and from 1 to 3 showers.



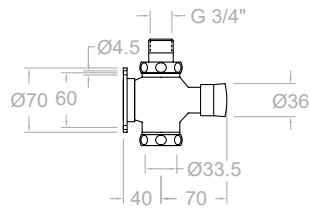

Cartucho Cartridge: 7406

**745602**

74F301474

76,80 €

WC de un agua (o premezclado).  
1-water WC (or premixed).

Tiempo Timing	15 ± 5 aseg
Caudal l/M Flow	≈ 25 l/min
Temperature	65°
Bar	1-5 Bar (3 recom)

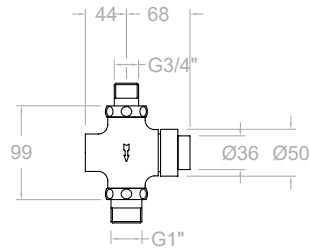

Cartucho Cartridge: 7407

**745702**

74F301473

103,40 €

WC empotrado. WC de un agua (o premezclado).  
1-water WC (or premixed).

Tiempo Timing	15 ± 5 aseg
Caudal l/M Flow	≈ 25 l/min
Temperature	65°
Bar	1-5 Bar (3 recom)

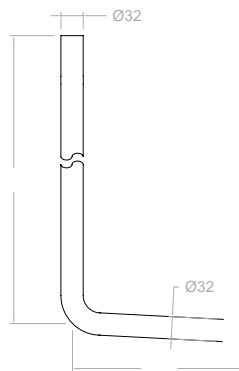
**746901**

74F306321

121,70 €

Conjunto de wc 745602+T76602+705.  
WC 745602+T76602+705.

**T76602**

74Z306320

42,20 €

Cromo tubo ø32 500x150 para ref. 745602.  
WC connection tube ø32 500x150 for ref. 745602.

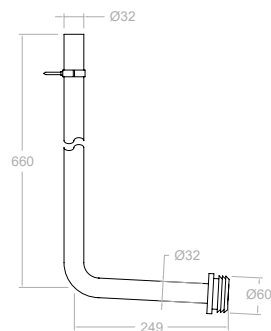
**7466**

212622

74,30 €

Tubo conexión a WC de Ø 32 mm para ref. 745602.  
WC connection tube of Ø 32 mm for ref. 745602.

T766+705+768

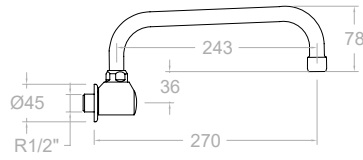

**748X1CAI30**

190347

55,80 €

Caño mural giratorio para comandos a pedal.  
Wall-mounted swivel spout for pedal controls.

**748X1SCA**

190356

29,40 €

Caño mural giratorio para comandos a pedal.  
Wall-mounted swivel spout for pedal controls.

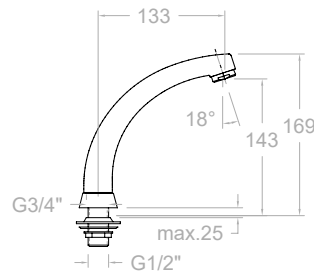

**74302**

74Z301675

82,10 €

Manguito con caño giratorio para pedal de suelo.  
Body with swivel spout for pedal control.

**74302S**

74Z301676

32,40 €

Cuerpo giratorio para caño fundido.  
Moving head without spout.

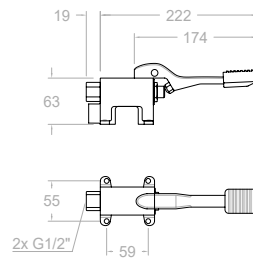

**7238**

261522

157,30 €

Pedal de suelo.  
Floor pedal.

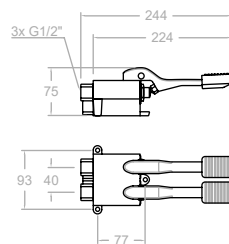

**7239**

261523

248,70 €

Pedal mezclador de suelo con agua fría-caliente.  
Floor mixer.

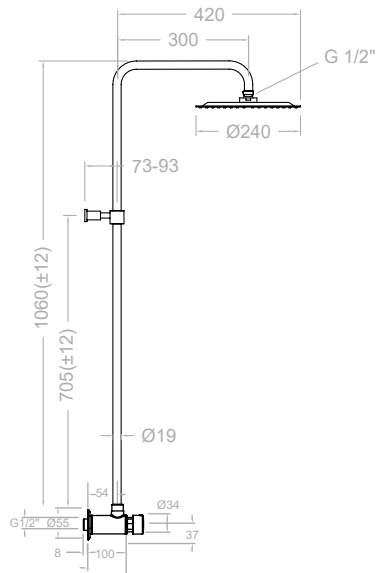
**745403RM250**

428,20 €

74D303890

745303 + T100N + RM250 + RGD



Gran Ducha de jardín o piscina con temporizado de 1 agua, con regulación de tiempo y de caudal. Con tubo de 1 metro y ducha de Ø 250 mm de acero inoxidable.

Large garden or pool shower with 1 water timed, with time and flow regulation. With 1 meter tube and stainless steel Ø 250 mm.

**745403RP240**

301,70 €

74D303891

745303 + T100N + RP240 + RGD



Gran Ducha de jardín o piscina con temporizado de 1 agua, con regulación de tiempo y de caudal. Con tubo de 1 metro y ducha de diametro 240 mm en ABS.

Large garden or pool shower with 1 water timed, with time and flow regulation. With 1 meter tube and ABS headshower Ø 240 mm.

Tiempo Timing	≈ 9 seg
Caudal l/M Flow	≈ 9 l/min
Descarga total Waterflow discharge	≈ 1,35 l

Cartucho Cartridge: 740203

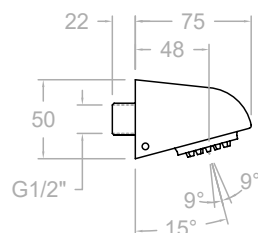
**712N**

160,30 €

240180

Ducha tonic antivandálica para empotrar.

Ducha tonic antivandalica for built-in.

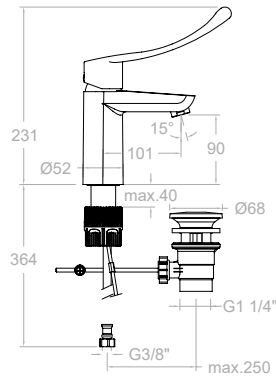

**BREH570211MED**

82,60 €

57A307457

Monomando Lavabo . Palanca gerontológica. Conexiones flexibles resistentes al choque térmico y al ataque químico de los procesos de desinfección antilegionela. Aireador limitador de 3,75 l/min. Tool Free.

Medical lever. The flexible connections are resistant to thermal shock and chemical protection during anti-legionella disinfection. Aerator 3.75 l/min. Tool Free-

**BREH570211V1169MED**

101,90 €

57A307458

Monomando de lavabo, con válvula automática 1<sup>1/4</sup>". Washbasin mixer with stainless steel pop-up waste 1<sup>1/4</sup>".

Ref. 1169 INOX

Cartucho Cartridge: 40100-3

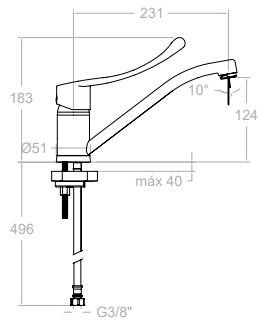

**BREH570901MED**

111,90 €

57E307462

Monomando de fregadero mural con caño bajo conformado corto de 22,5cm.

Wall sink mixer with with swivel short spout 22,5 cm.

Cartucho Cartridge: 35100-3

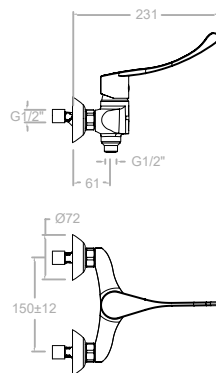

**BREH570812SMED**

111,90 €

57D307461

Monomando de fregadero mural con caño bajo conformado corto de 22,5cm.

Wall sink mixer with with swivel short spout 22,5 cm.

Cartucho Cartridge: 35100-3



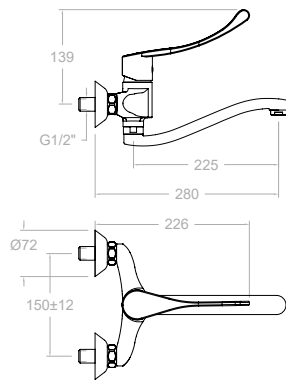

**BREH570701CCMED**  
57E307460

111,90 €

Monomando de fregadero mural con caño bajo conformado corto de 22,5cm.  
Wall sink mixer with with swivel short spout 22,5 cm.



Cartucho Cartridge: 35100-3

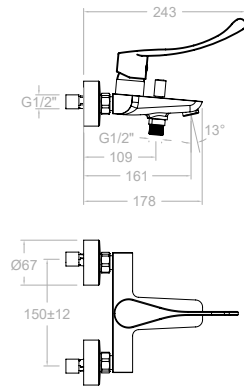

**BREH570502SMED**  
57C307459

172,00 €

Monomando de baño- ducha sin equipo de ducha.  
Bath and shower mixer without shower kit.



Cartucho Cartridge: 35200-2

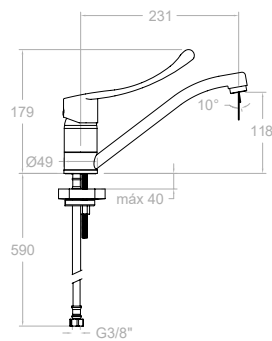

**6999KMED2**  
69E306225

70,60 €

Monomando vertical de fregadero con caño giratorio conformado con maneta médica.  
High-rise sink mixer with formed swivel spout and medical handle.



Cartucho Cartridge: 40300-2

# Showroom

# Showroom

ramonsoler.





# Expositores RS Space Lux

## RS Space Lux displays

### 1- RS Lux Góndola

Expositor góndola 40x90x80cm, que se servirá con 5 taladros para facilitar la instalación de las griferías.

Gondola display 40x90x80cm, which will be delivered with 5 holes to facilitate faucets installation.

CÓDIGO CODE ALPHA

CÓDIGO CODE	ALPHA		
MXK307990	RSLUXWGONDOLA	RS LUX GÓNDOLA white	185,00 €/UD
MXK307991	RSLUXBGONDOLA	RS LUX GÓNDOLA black	185,00 €/UD
MXK308004	RSLUXCGONDOLA	RS LUX GÓNDOLA CEMENT	185,00 €/UD

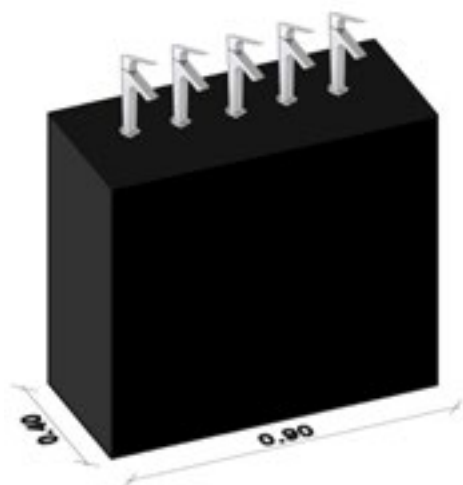

## 2- Mini Expolux

MEDIDAS 120 cm (altura) x 90 cm (ancho) x 19mm (fondo). Expositor para 2 rociadores + 2 empotrados, que se colgará con pletinas.

MEASUREMENTS 120 cm (height) x 90 cm (width) x 19mm (depth). Display for 2 Head Showers + 2 concealed, to be hung with plates.

CÓDIGO CODE	ALPHA			
MKX307994	EXPOLUXWMINI		MINI EXPOLUX WHITE	125,00 €/UD
MKX307995	EXPOLUXBMINI		MINI EXPOLUX BLACK	75,00 €/UD
MKX308006	EXPOLUXCMINI		MINI EXPOLUX CEMENT	75,00 €/UD

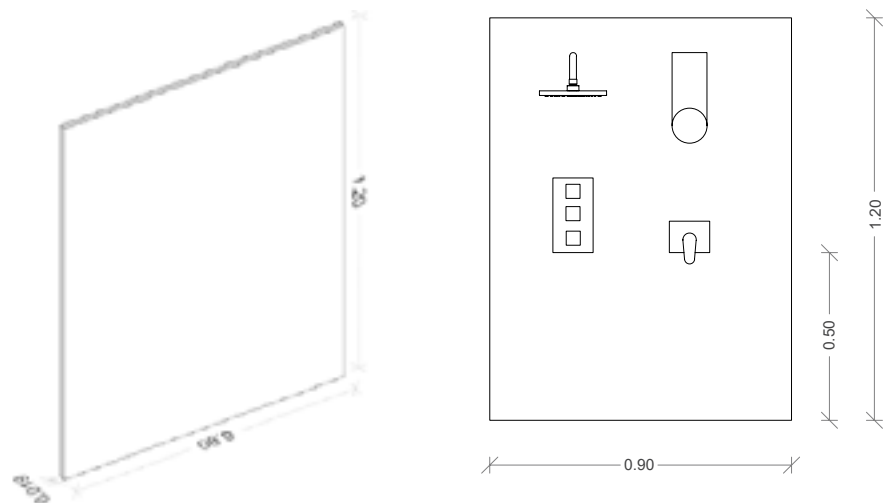

## 3- Mini Expolux + RS Lux Góndola

MEDIDAS 120 cm (altura) x 90 cm (ancho) x 19mm (fondo). Expositor para 2 rociadores + 2 empotrados, que se colgará con pletinas.

MEASUREMENTS 120 cm (height) x 90 cm (width) x 19mm (depth). Display for 2 Head Showers + 2 concealed, to be hung with plates.

CÓDIGO CODE	ALPHA			
MKX303237	EXPOLUXWMINI		MINI EXPOLUX WHITE	
MKX303238	EXPOLUXBMINI		MINI EXPOLUX BLACK	
MKX304381	EXPOLUXCMINI		MINI EXPOLUX CEMENT	

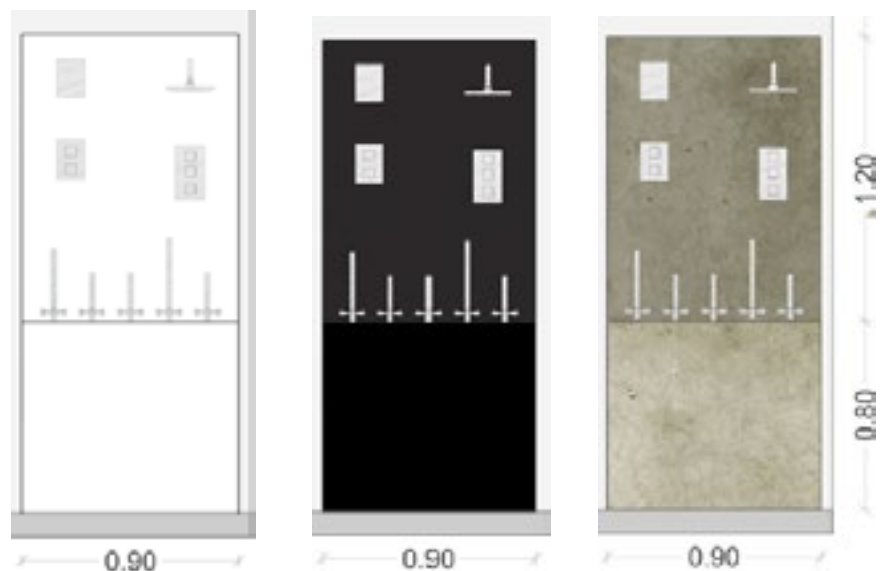

## 4- Expolux

MEDIDAS 200 cm (altura) x 90 cm (ancho) x 19mm (fondo). Expositor para 2 conjuntos de ducha que incluyan flexo + teleducha, que se colgará con pletinas.

MEASUREMENTS 200 cm (height) x 90 cm (width) x 19mm (depth). Display for 2 shower sets including flexo + hand shower, which will be hung with plates.

CÓDIGO CODE	ALPHA		
MKX307992	EXPOLUXW1P	EXPOLUX WHITE	125,00 €/UD
MKX307993	EXPOLUXB1P	EXPOLUX BLACK	125,00 €/UD
MKX308007	EXPOLUXC1P	EXPOLUX CEMENT	125,00 €/UD

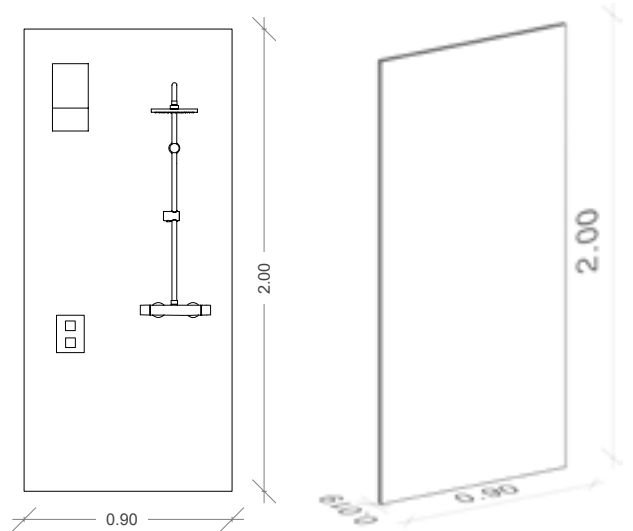

## 6- RS Lux Kitchen Simple 55

Expositor Kitchen Simple de anchura de 110 x80 x 40 cm. Expositor que se servirá con 5 taladros separados 22 cm de eje a eje, para facilitar la instalación de las griferías.

La tapa superior es registrable. Incluye logo Ramon Soler de vinilo 6 cm altura, en la parte superior izquierda a 6 cm.

MEASUREMENTS 120 cm (height) x 90 cm (width) x 19mm (depth). Display for 2 Head Showers + 2 concealed, to be hung with plates.

CÓDIGO CODE	ALPHA		
MKX308045		RSLUX CEMENT KITCHEN 55 SIMPLE GONDOLA	185,00 €/UD

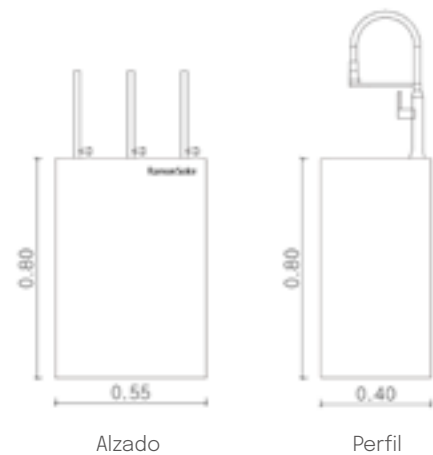

## 6- RS Lux Kitchen Simple

Expositor Kitchen Simple de anchura de 110 x 80 x 40 cm. Expositor que se servirá con 5 taladros separados 22 cm de eje a eje, para facilitar la instalación de las griferías.

La tapa superior es registrable. Incluye logo Ramon Soler de vinilo 6 cm altura, en la parte superior izquierda a 6 cm.

MEASUREMENTS 120 cm (height) x 90 cm (width) x 19mm (depth). Display for 2 Head Showers + 2 concealed, to be hung with plates.

CÓDIGO CODE	ALPHA		
MKX308010	RSLUXWKGONDOLA	RSLUX WHITE KITCHEN SIMPLE GONDOLA	200,00 €/UD
MKX308011	RSLUXBKSGONDOLA	RSLUX BLACK KITCHEN SIMPLE GONDOLA	200,00 €/UD
MKX308012	RSLUXCKSGONDOLA	RSLUX CEMENT KITCHEN SIMPLE GONDOLA	200,00 €/UD

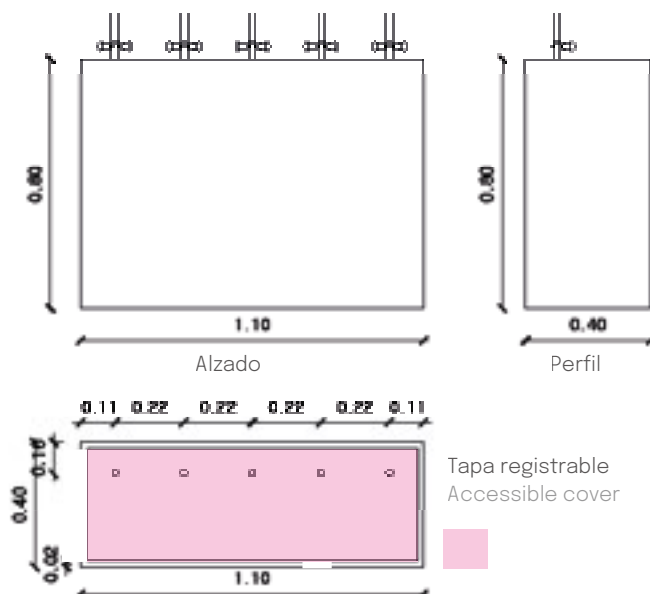

## 4- RS Lux Kitchen Escalera

Medidas: anchura de 110cm, y tendrá dos alturas: la primera de 90 cm x 30 cm de fondo y la segunda de 110 cm x 30 cm de fondo. Expositor en escalera que se servirá con 9 taladros (4 en el piso superior y 5 en el piso inferior) para exponer griferías de cocina. El expositor tendrá 4 ruedas integradas, para su fácil desplazamiento, incluidas en la altura total de 90cm.

Measurements: 110cm width, with two heights: the first 90 cm x 30 cm deep and the second 110 cm x 30 cm deep. Staircase display that will be delivered with 9 drills (4 on the upper floor and 5 on the lower floor) to exhibit kitchen faucets. The display will have 4 integrated wheels, for easy movement, included in the total height of 90cm.

CÓDIGO CODE	ALPHA		
MKX307998	RSLUXWKITCHEN	RS LUX KITCHEN ESCALERA white	420,00 €/UD
MKX307999	RSLUXBKITCHEN	RS LUX KITCHEN ESCALERA black	420,00 €/UD
MKX308008	RSLUXCKITCHEN	RS LUX KITCHEN ESCALERA CEMENT	420,00 €/UD

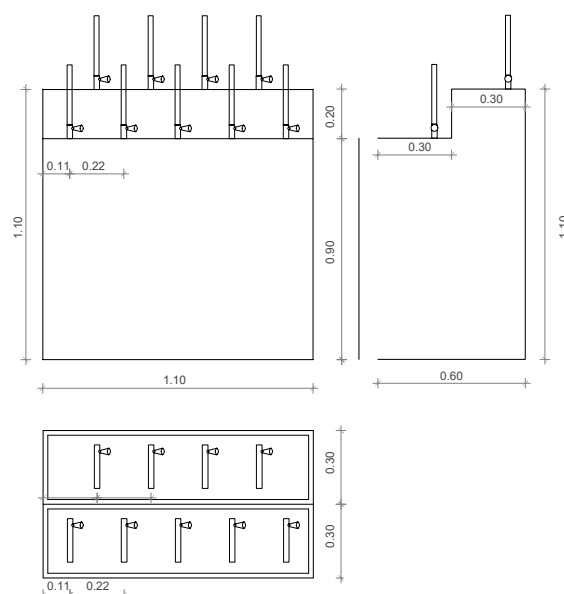

## 4- Rs Lux Torre 4 caras

Columna exenta de 4 caras de 50cm de ancho y 220cm de altura. Incluye logo Ramon Soler de vinilo medida de la R mayúscula 3 cm altura, y colocado centrado a 40 cm del suelo.

Free-standing column, 4 sides. 50cm width and 220cm height. It includes the "Ramon Soler" vinyl logo. The capital "R" is 3 cm of height, and is placed in the center of the column at 40cm from the ground.

CÓDIGO CODE	ALPHA		
MKX308046	MKX308021	RSLUX CEMENT TORRE 4 CARAS	310,00 €/UD

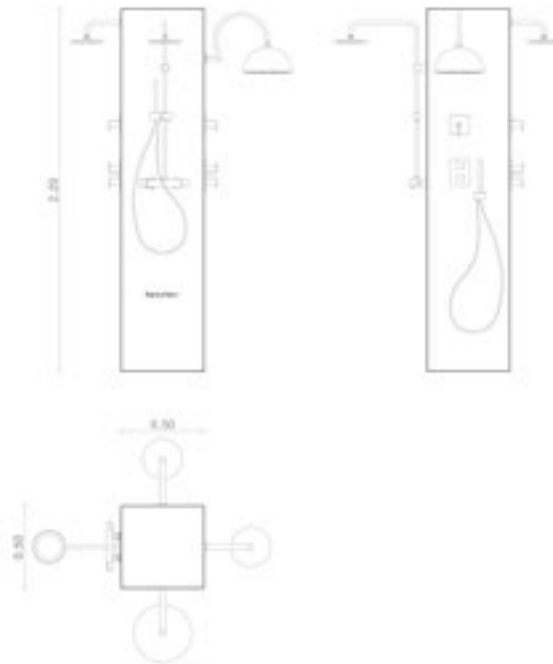

## 5- Expolux Accesorios Baño Ergos

En las planchas se pueden instalar accesorios de baño y WC Magnet en acabado: oro cepillado, níquel cepillado, negro mate, cromado o combinar en una misma plancha todos los acabados.

It is possible to install bathroom accessories and WC Magnet in the column walls. In brushed gold, brushed nickel, matte black and chromed finishes. Choose one finish per wall or combine them.

CÓDIGO CODE	ALPHA		
MKX308021	MKX307038	EXPOLUX CEMENT ACCESORIOS	455,00 €/UD

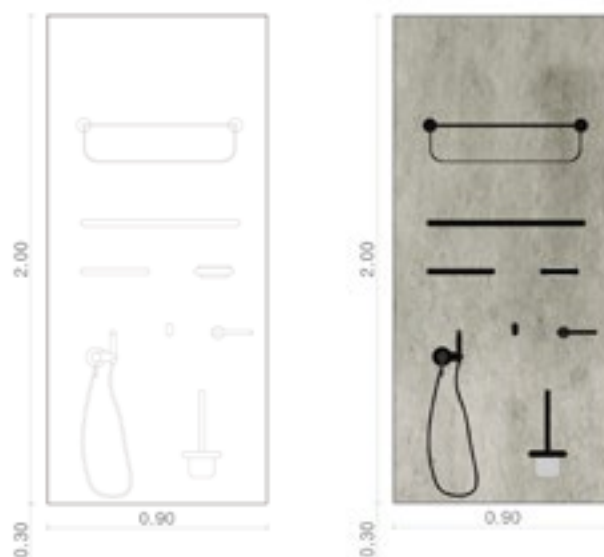

## 5- RS Lux Peana

Expositor para 1 grifería columna de lavabo o bañera. Peana 6x40x40 cm. con 1 taladro central.

Stand 40x40x6cm made of wood with central drilling, available in different colors.

CÓDIGO CODE	ALPHA			
MKX304823	PWMC		PEANA WHITE PARA MONOMANDO COLUMNA LAVABO Y BAÑO	60,00 €/UD
MKX304844	PBMC	■	PEANA BLACK PARA MONOMANDO COLUMNA LAVABO Y BAÑO	60,00 €/UD
MKX304845	PCMC	■	PEANA CEMENT PARA MONOMANDO COLUMNA LAVABO Y BAÑO	60,00 €/UD



## 3- Combi Lux

MEDIDAS 120 cm (altura) x 90 cm (ancho) x 19mm (fondo). Expositor para 2 rociadores + 2 empotrados, que se colgará con pletinas.

MEASUREMENTS 120 cm (height) x 90 cm (width) x 19mm (depth). Display for 2 Head Showers + 2 concealed, to be hung with plates.

CÓDIGO CODE	ALPHA			
MKX308019	EXPOCOMBILUX		COMBI LUX CEMENT 90	340,00 €/UD
MKX308020	EXPOCOMBILUX	■	COMBI LUX CEMENT 130	375,00 €/UD

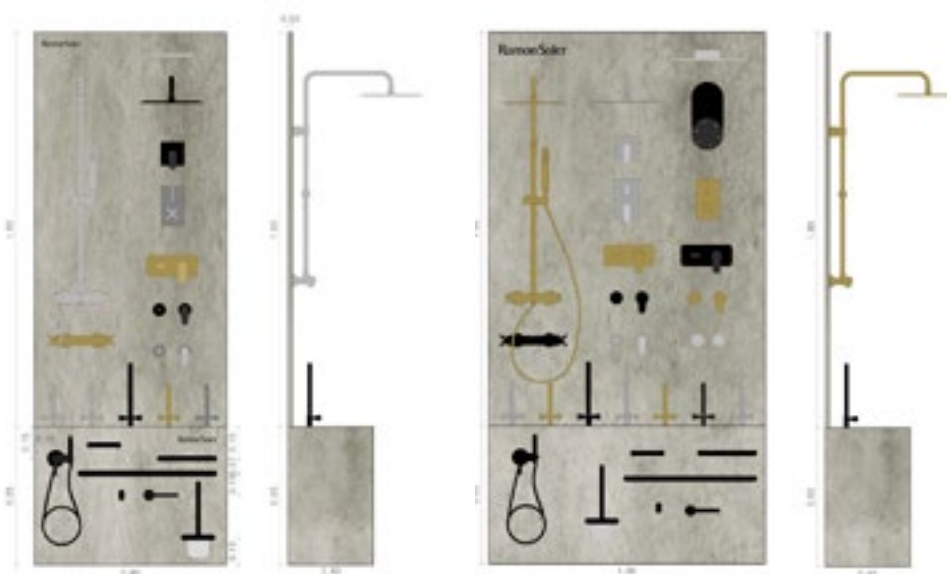



# Expositores Ramon Soler

## Ramon Soler displays

### Displays



CÓDIGO SAP	DESCRIPCIÓN ARTICULO	PVP
MKX307970	EXPOBLACK 1 S	190,80 €
MKX307971	EXPOBLACK 2 S	155,80 €
MKX307972	EXPOBLACK 3 S	194,20 €
MKX307973	EXPOBLACK 4 S	160,60 €
MKX307974	EXPOBLACK 5 S	145,60 €
MKX307975	EXPOBLACK 1 P	190,80 €
MKX307976	EXPOBLACK 2 P	155,80 €
MKX307977	EXPOBLACK 3 P	194,20 €
MKX307978	EXPOBLACK 4 P	160,60 €
MKX307979	EXPOBLACK 5 P	145,60 €
MKX307959	EXPOWHITE 1 S	181,90 €
MKX307961	EXPOWHITE 2 S	150,30 €
MKX307962	EXPOWHITE 3 S	186,10 €
MKX307963	EXPOWHITE 4 S	152,80 €
MKX307964	EXPOWHITE 5 S	143,10 €
MKX307965	EXPOWHITE 1 P	181,90 €
MKX307966	EXPOWHITE 2 P	150,30 €
MKX307967	EXPOWHITE 3 P	186,10 €
MKX307968	EXPOWHITE 4 P	152,80 €
MKX307969	EXPOWHITE 5 P	143,10 €
250935	EXPOWHITE BLAUTHERM	190,80 €
MKX307997	PEANA OVALADA TRANSPARENTE Ø110X12 CON 3 TORNILLOS	22,90 €
MKX307989	PEANA OVALADA TRANSPARENTE Ø145X15 CON 3 TORNILLOS	34,60 €
MKX301977	PIE METALICO BLANCO PARA EXPOWHITE BLAUTHERM	190,80 €
MKX304356	PIE METALICO NEGRO PARA EXPOCEMENT	92,40 €
MKX308003	EXPOCEMENT	150,30 €
MKX308009	EXPOCEMENT PARA KIT EMPOTRADO BLAUTHERM	190,80 €

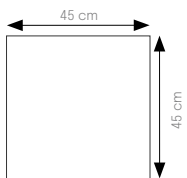

Montaje de suelo Assembly Floor

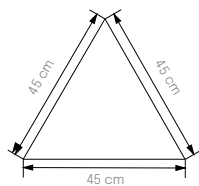

Montaje de pared Assembly wall

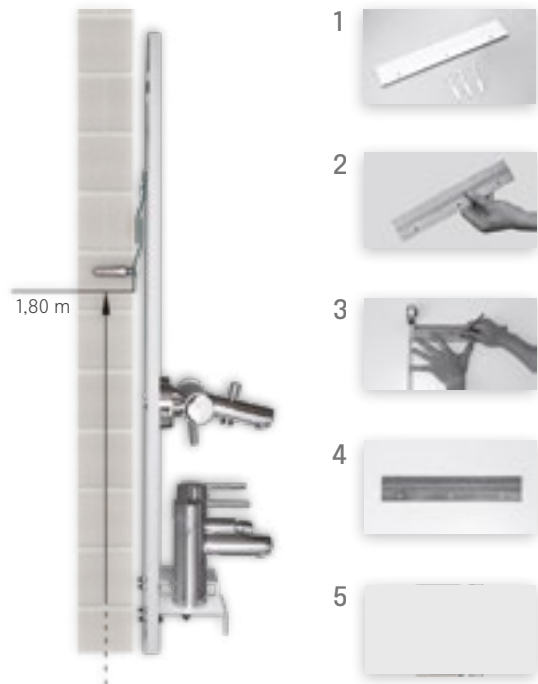
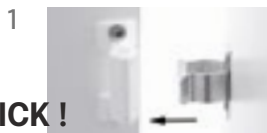



## Expoblack /Expowhite

Expoblack 01  
Expowhite 01Conjunto baño  
Bath sets

Suelo Floor

**Ref.** Expoblack 1 S  
**Ref.** Expowhite 1 S

Pared Wall

**Ref.** Expoblack 1 P  
**Ref.** Expowhite 1 PExpoblack 02  
Expowhite 02Grandes duchas  
Shower sets

Suelo Floor

**Ref.** Expoblack 2 S  
**Ref.** Expowhite 2 S

Pared Wall

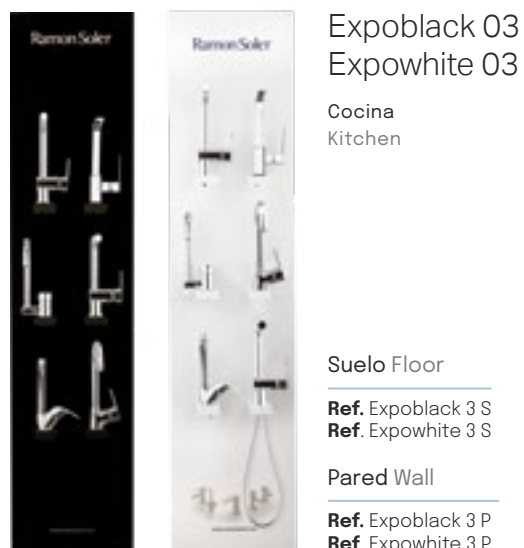
**Ref.** Expoblack 2 P  
**Ref.** Expowhite 2 PExpoblack 03  
Expowhite 03Cocina  
Kitchen

Suelo Floor

**Ref.** Expoblack 3 S  
**Ref.** Expowhite 3 S

Pared Wall

**Ref.** Expoblack 3 P  
**Ref.** Expowhite 3 PExpoblack 04  
Expowhite 04Conjuntos con  
barras de ducha  
Shower sets with  
slide bar

Suelo Floor

**Ref.** Expoblack 4 S  
**Ref.** Expowhite 4 S

Pared Wall

**Ref.** Expoblack 4 P  
**Ref.** Expowhite 4 P

# Realice su propia composición

Undertake your own distribution

Personalice el resultado final. En función de la grifería escogida, debe pedir los soportes correspondientes.

Personalize the final result. Choose the wall brackets according to the chosen taps.

## Expoblack /Expowhite

### Expoblack 05 Expowhite 05



**Suelo Floor**

**Ref.** Expoblack 5 S  
**Ref.** Expowhite 5 S

**Pared Wall**

**Ref.** Expoblack 5 P  
**Ref.** Expowhite 5 P

### Accesorios Accessories

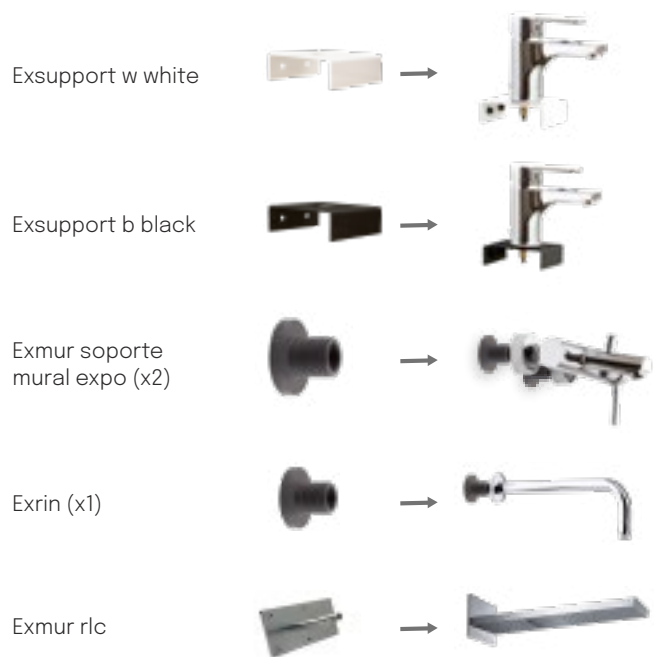

\* Las griferías empotradas deben pedirse sin cuerpos internos. Ver catálogo referencias EX

\* The taps recessed which are wall mounted should be ordered without internal fittings. See catalogue reference pages EX



### Ejemplos Examples

**Expoblack Expowhite Cocina**  
**Expoblack Expowhite Kitchen**

Mostrador  
 Bench mounted  
 models

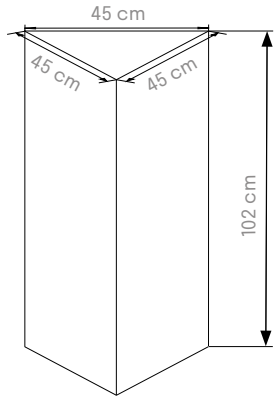

Mostrador  
 Cabinet

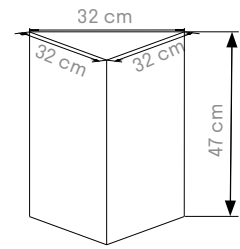

**Miniblack**  
 Ex: MB0 + MB3 + MB2  
 + MBT3

**Miniwhite**  
 Ex: MW1 + MW4 + MW0  
 + MWT1 + RGW

Caras Faces Elija su composición: 3 caras + una tapa y, opcional, una base rotatoria.  
 Select your choice: 3 sides + one lid and, optional, one turning base



Ref. MKX308028



Ref. MKX308029



Ref. MKX308030



Ref. MKX308031



Ref. MKX308032



Ref. MKX308022



Ref. MKX308024



Ref. MKX308025



Ref. MKX308026



Ref. MKX308027

Accesorios - Tapa Accessories - Lid



Ref. MWT0



Ref. MWT1



Ref. MBT0



Ref. MBT1



Ref. MWT3



Base giratoria  
 Turning base  
 RGW



Ref. MBT3



Base giratoria  
 Turning base  
 RGB

## Sistema exposición de hidroterapia

Proyecto Hidroterapia 2021 busca ampliar la visibilidad de los accesorios de Industrias Ramon Soler, y a su vez, aumentar la confianza y satisfacción del cliente en el momento de la compra.

Hydrotherapy Project 2021 seeks to expand the visibility of the accessories of Industrias Ramon Soler, and in turn, increase the confidence and customer satisfaction at the time of purchase.

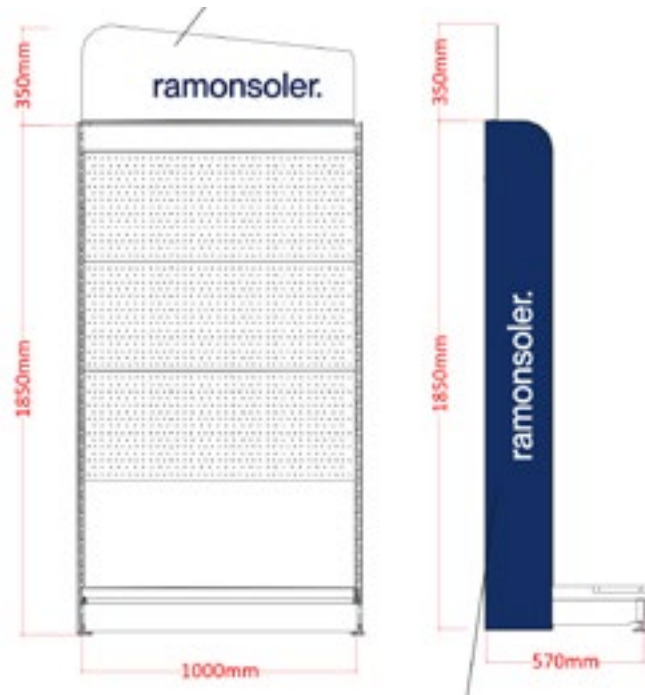

NOTORIEDAD MARCA  
BRAND AWARENESS

INNOVACIÓN & PROMOCION PRODUCTO  
INNOVATION & PRODUCT PROMOTION

25 GANCHOS BLISTER  
25 BLISTER HOOKS

AUTOSERVICIO  
SELF SERVICE

1 FLEXOS  
FLEXIBLE SHOWER

2 TELEDUCHAS  
HANDSHOWER

3 BARRAS DE DUCHA  
SHOWER BAR

4 BARRAS DE DUCHA CON ACCESORIOS  
SHOWER BAR WITH ACCESORIOS



Ref. MKX308013

Disponible en dos acabados para diversificar el producto en gama distribución y gama alta.  
Available in two finishes to diversify the product in distribution range and high range.



1MHD	MKX305112	EXPOSITOR HIDROTERAPIA DISTRIBUCION	
982402S	300179	<i>Cromo barra ducha polo 630mm ø22</i> <i>Chrome shower bar polo 630mm ø22</i>	
982402T3	300183	<i>Cromo barra ducha con accesorios</i> <i>Chrome shower bar with accesories (982402s+5840t3+1128c)</i>	
982402T1	300182	<i>Cromo barra ducha con accesorios</i> <i>Chrome shower bar with accesories 982402 t1 (982402s+3520t1+1128c)</i>	
7780S	99H300927	<i>Cromo barra ducha universal 800mm ø22</i> <i>Chrome shower bar universal 800mm ø22</i>	
7780T3	99H300926	<i>Cromo barra ducha con accesorios</i> <i>Chrome shower bar with accesories 7780 t3 (7780s+5840t3+1128c)</i>	
7780T1	261595	<i>Cromo barra ducha con accesorios</i> <i>Chrome shower bar with accesories 7780 t1 (7780s+3520t1+1128c)</i>	
2876BT	99Z303717	<i>Teleducha cromo 3f antical</i> <i>Chrome handshower 3f</i>	
2876BTNM	261593	<i>Teleducha negro mate 3f antical</i> <i>Black matte handshower 3f</i>	
3520T1	99Z305988	<i>Teleducha 1f antical rs</i> <i>Chrome handshower 3f</i>	
1128C	MKX301510	<i>Flexo 1,55m antitwist system</i> <i>Flexible shower</i>	



1MHD	MKX305112	EXPOSITOR HIDROTERAPIA DISTRIBUCION	
982402S	300179	<i>Cromo barra ducha polo 630mm ø22</i> <i>Chrome shower bar polo 630mm ø22</i>	
982402T3	300183	<i>Cromo barra ducha con accesorios</i> <i>Chrome shower bar with accesories (982402s+5840t3+1128c)</i>	
982402T1	300182	<i>Cromo barra ducha con accesorios</i> <i>Chrome shower bar with accesories 982402 t1 (982402s+3520t1+1128c)</i>	
7780S	99H300927	<i>Cromo barra ducha universal 800mm ø22</i> <i>Chrome shower bar universal 800mm ø22</i>	
7780T3	99H300926	<i>Cromo barra ducha con accesorios</i> <i>Chrome shower bar with accesories 7780 t3 (7780s+5840t3+1128c)</i>	
7780T1	261595	<i>Cromo barra ducha con accesorios</i> <i>Chrome shower bar with accesories 7780 t1 (7780s+3520t1+1128c)</i>	
982402S	300179	<i>Cromo barra ducha polo 630mm ø22</i> <i>Chrome shower bar polo 630mm ø22</i>	
982402T3	300183	<i>Cromo barra ducha con accesorios</i> <i>Chrome shower bar with accesories (982402s+5840t3+1128c)</i>	
982402T1	300182	<i>Cromo barra ducha con accesorios</i> <i>Chrome shower bar with accesories 982402 t1 (982402s+3520t1+1128c)</i>	
7780S	99H300927	<i>Cromo barra ducha universal 800mm ø22</i> <i>Chrome shower bar universal 800mm ø22</i>	
7780T3	99H300926	<i>Cromo barra ducha con accesorios</i> <i>Chrome shower bar with accesories 7780 t3 (7780s+5840t3+1128c)</i>	
7780T1	261595	<i>Cromo barra ducha con accesorios</i> <i>Chrome shower bar with accesories 7780 t1 (7780s+3520t1+1128c)</i>	
982402S	300179	<i>Cromo barra ducha polo 630mm ø22</i> <i>Chrome shower bar polo 630mm ø22</i>	
982402T3	300183	<i>Cromo barra ducha con accesorios</i> <i>Chrome shower bar with accesories (982402s+5840t3+1128c)</i>	
982402T1	300182	<i>Cromo barra ducha con accesorios</i> <i>Chrome shower bar with accesories 982402 t1 (982402s+3520t1+1128c)</i>	
7780S	99H300927	<i>Cromo barra ducha universal 800mm ø22</i> <i>Chrome shower bar universal 800mm ø22</i>	
2876BT	99Z303717	<i>Teleducha cromo 3f antical</i> <i>Chrome handshower 3f</i>	
2876BTNM	261593	<i>Teleducha negro mate 3f antical</i> <i>Black matte handshower 3f</i>	
982402S	300179	<i>Cromo barra ducha polo 630mm ø22</i> <i>Chrome shower bar polo 630mm ø22</i>	
982402T3	300183	<i>Cromo barra ducha con accesorios</i> <i>Chrome shower bar with accesories (982402s+5840t3+1128c)</i>	
982402T1	300182	<i>Cromo barra ducha con accesorios</i> <i>Chrome shower bar with accesories 982402 t1 (982402s+3520t1+1128c)</i>	
7780S	99H300927	<i>Cromo barra ducha universal 800mm ø22</i> <i>Chrome shower bar universal 800mm ø22</i>	
7780S	99H300927	<i>Cromo barra ducha universal 800mm ø22</i> <i>Chrome shower bar universal 800mm ø22</i>	



## Modulos de exposici3n



### CUBOS EXPOSICI3N GRIFERIA

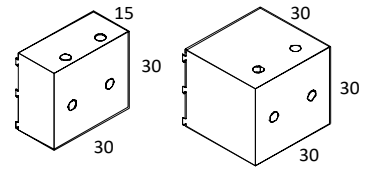

### SISTEMA MODULAR METALICO COMPUESTO :

- 1/ estanterias y cubos regulables
- 2/ banderolas superiores & laterales m1s logo

### METAL PIECES SYSTEM COMPOSED BY:

- 1/ adjustable shelves & cubes
- 2/ top & lateral banners + logo

## Opciones Options

M3dulo 1MG  
MKX308033

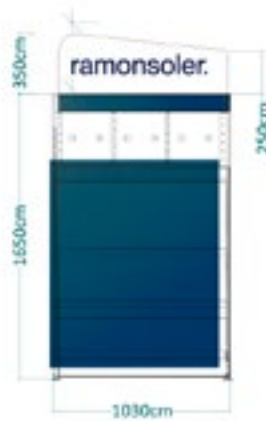

M3dulo 2MG  
MKX308034



M3dulo 2MGD  
MKX308035

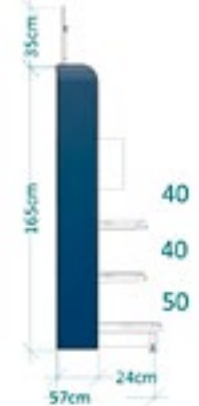

M3dulo 4MGD  
MKX308036

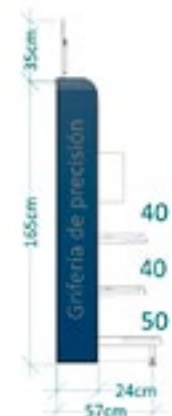
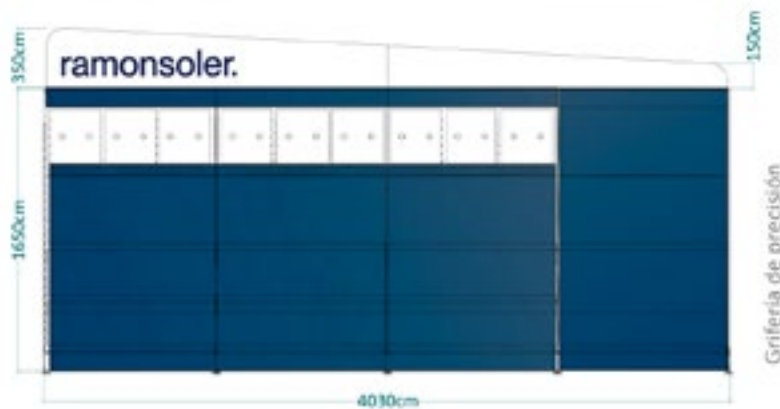

## Peanas

## Bases



ALEXIA	EX3602NM	MKX304289	EX3602 SCHWARZ MATT + ACRYLSOCKEL Ø145X15
	EX3602OC	MKX304350	EX3602 GOLD GEBÜRSTET + ACRYLSOCKEL Ø145X15
	EX3604	MKX303566	EX3604 CHROM + ACRYLSOCKEL Ø145X15
	EX3604NM	MKX303567	EX3604 SCHWARZ MATT + ACRYLSOCKEL Ø145X15
	EX3604NC	MKX303976	EX3604 NICKEL GEBÜRSTET + ACRYLSOCKEL Ø145X15
	EX3604OC	MKX303568	EX3604 GOLD GEBÜRSTET + ACRYLSOCKEL Ø145X15
	EX3610	MKX303977	EX3610 CHROM + ACRYLSOCKEL Ø145X15
	EX3610NM	MKX304847	EX3610 SCHWARZ MATT + ACRYLSOCKEL Ø145X15
AROLA	EX2601	MKX304541	EX2601 CHROM + ACRYLSOCKEL Ø145X15
	EX2602	MKX304347	EX2602 CHROM + ACRYLSOCKEL Ø145X15
ÁTICA	EX7501	MKX303978	EX7501 + ACRYLSOCKEL Ø145X15
	EX7510	MKX303979	EX7510 + ACRYLSOCKEL Ø145X15
DRAKO	EX3304	MKX304849	EX3304 CHROM + ACRYLSOCKEL Ø145X15
	EX330402	MKX303936	EX330402 CHROM + ACRYLSOCKEL Ø145X15
	EX330403	MKX304818	EX330403 CHROM + ACRYLSOCKEL Ø145X15
KUATRO NK	EX4902	261779	EX4902 + ACRYLSOCKEL Ø110X12

NEW FLY	EX570101	MKX304348	EX3602 SCHWARZ MATT + ACRYLSOCKEL Ø145X15
	EX570101NM	MKX304436	EX3602 GOLD GEBÜRSTET + ACRYLSOCKEL Ø145X15
	EX570102	MKX304437	EX3604 CHROM + ACRYLSOCKEL Ø145X15
	EX570201	MKX304349	EX3604 SCHWARZ MATT + ACRYLSOCKEL Ø145X15
	EX570301	MKX305209	EX3604 NICKEL GEBÜRSTET + ACRYLSOCKEL Ø145X15
	EX579101	MKX304817	EX3604 GOLD GEBÜRSTET + ACRYLSOCKEL Ø145X15
	EX570103	MKX305410	EX3610 CHROM + ACRYLSOCKEL Ø145X15
RS-CROSS	EX6202	MKX303981	EX3610 SCHWARZ MATT + ACRYLSOCKEL Ø145X15
RS-Q	EX930102	MKX303980	EX2601 CHROM + ACRYLSOCKEL Ø145X15
TITANIUM	EX1801	MKX305296	EX2602 CHROM + ACRYLSOCKEL Ø145X15
	EX1802	MKX304438	EX7501 + ACRYLSOCKEL Ø145X15
	EX1891	MKX303546	EX7510 + ACRYLSOCKEL Ø145X15
TZAR	EX340201	MKX303532	EX3304 CHROM + ACRYLSOCKEL Ø145X15
	EX340401	MKX303527	EX330402 CHROM + ACRYLSOCKEL Ø145X15
	EX340401NM	MKX303530	EX330403 CHROM + ACRYLSOCKEL Ø145X15
	EX340401NC	MKX303528	EX3604 SCHWARZ MATT + ACRYLSOCKEL Ø145X15
	EX340401OC	MKX303529	EX3604 NICKEL GEBÜRSTET + ACRYLSOCKEL Ø145X15
	EX341001	MKX303531	EX3604 GOLD GEBÜRSTET + ACRYLSOCKEL Ø145X15
	EX341001OC	MKX304848	EX3610 CHROM + ACRYLSOCKEL Ø145X15
URBAN CHIC	EX210101	MKX303162	EX3610 SCHWARZ MATT + ACRYLSOCKEL Ø145X15
	EX211001	MKX303923	EX2601 CHROM + ACRYLSOCKEL Ø145X15
	EX213101	MKX303526	EX3604 GOLD GEBÜRSTET + ACRYLSOCKEL Ø145X15
YPSILON PLUS	EX6401	MKX305297	EX3610 CHROM + ACRYLSOCKEL Ø145X15
	EX6402	MKX302043	EX3610 SCHWARZ MATT + ACRYLSOCKEL Ø145X15
	EX6410	MKX304352	EX2601 CHROM + ACRYLSOCKEL Ø145X15
	EX6491	MKX305361	EX2601 CHROM + ACRYLSOCKEL Ø145X15

## EXPO2ACCEVACIO01

MKX308016

Expositor

## EXPO2ACCE01

MKX305962

(1219L+3790+1219LNM+3790NM)

## EXPO2ACCE02

MKX305963

## EXPO2ACCE02

MKX305963



## EXPO2ACCE01

MKX305962

## EXPO2ACCE02

MKX305963

## EXPO3

MKX308001

(ohne Armaturen)

## EXPOTOOLFREE

MKX306959



## EXPO2

MKX307982



## EXPOWCMAGNET

336801 MKX303379

## EXPOWCMAGNET

336801 MKX303379



(\*) Para más información consulte a su comercial de zona.

(\*) For any reques contact with your commercial agent.



## DUMMIES SIN CUERPOS EMPOTRADOS

## DUMMIES WITHOUT CONCEALED BODIES



	EXPEMPCT	MKX301268	Expositor empotrado lavabo tubo
ALEXIA	EX3621	MKX301541	EX3621 (EXPEMPCT+3600N-35+RB21S+RB21H+CLET)
	EX362101NM	MKX304224	EX362101 NEGRO MATE (EXPEMPCTNM+3600N-35NM+RB21SNM+RB21HNM+CLETNM)
	EX362101NC	MKX304800	EX362101 NIQUEL CEPILLADO (EXPEMPCTNC+3600N-35NC+RB21SNC+RB21HNC+CLETNC)
	EX362101OC	MKX305288	EX362101 ORO CEPILLADO (EXPEMPCTOC+3600N-35OC+RB21SOC+RB21HOC+CLETOC)
	EX362103	MKX304275	EX362103 CROMO (EXPEMPCT+3600N-35+RB21S+RB21H+CLET24)
	EX362103NM	MKX305294	EX362103 NEGRO MATE (EXPEMPCTNM+3600N-35NM+RB21SNM+RB21HNM+CLET24NM)
	EX362103NC	MKX305307	EX362103 NIQUEL CEPILLADO (EXPEMPCTNC+3600N-35NC+RB21SNC+RB21HNC+CLET24NC)
	EX362103OC	MKX305308	EX362103 ORO CEPILLADO (EXPEMPCTOC+3600N-35OC+RB21SOC+RB21HOC+CLET24OC)
ÁTICA	EX7520	MKX301544	EX7520 (EXPEMPCT+7500N-35+RB20+CLET)
	EX752003	MKX303291	EX752003 (EXPEMPCT+7500N-35+RB20+CLET24)
	EX752102	MKX301543	EX752102 (EXPEMPCT+7500N-35+RB21S+RB21H+CLET)
	EX752103	MKX305295	EX752103 (EXPEMPCT+7500N-35+RB21S+RB21H+CLET24)
DRAKO	EX332002	MKX301546	EX332002 (EXPEMPCT+3300N-35+RB20+CLET)
	EX332102	MKX301545	EX332102 (EXPEMPCT+3300N-35+RB21S+RB21H+CLET)
RS-Q	EX932002	MKX301548	EX932002 (EXPEMPCT+9400N-35+RB20+CLET)
	EX932102	MKX301547	EX932102 (EXPEMPCT+9400N-35+RB21S+RB21H+CLET)
TZAR	EX342101	MKX302940	EX342101 (EXPEMPCT+3400N-35+RB21S+RB21H+CLET)
	EX342103	MKX305309	EX342103 CROMO (EXPEMPCT+3400N-35+RB21S+RB21H+CLET24)
	EX342103NM	MKX303492	EX342103 NEGRO MATE (EXPEMPCTNM+3400N-35NM+RB21SNM+RB21HNM+CLET24NM)
	EX342103NC	MKX305310	EX342103 NIQUEL CEPILLADO (EXPEMPCTNC+3400N-35NC+RB21SNC+RB21HNC+CLET24NC)
	EX342103OC	MKX304564	EX342103 ORO CEPILLADO (EXPEMPCTOC+3400N-35OC+RB21SOC+RB21HOC+CLET24OC)
YPSILON	EX662002	MKX301550	EX662002 (EXPEMPCT+6600N-35+RB20+CLET)
	EX 662102	MKX301549	EX662102 (EXPEMPCT+6600N-35+RB21S+RB21H+CLET)
YPSILON PLUS	EX642002	MKX301552	EX642002 (EXPEMPCT+6400N-35+RB20+CLET)
	EX642102	MKX301551	EX642102 (EXPEMPCT+6400N-35+RB21S+RB21H+CLET)



EXPEMPCF		MKX301269	EXPOSITOR CROMO EMPOTRADO
EXPEMPCFNM	EXPEMPCFNM	MKX303288	EXPOSITOR NEGRO MATE EMP. LAVABO ALEXIA, KUATRO Y URBAN CHIC
EXPEMPCFOC	EXPEMPCFOC	MKX304002	EXPOSITOR ORO CEPILLADO EMP. LAVABO ALEXIA, KUATRO Y URBAN CHIC
ALEXIA	EX3620	MKX301542	EX3620 CROMO (EXPEMPCF+3600N-35+KXB20+CLEA)
ALEXIA	EX3620NM	MKX303282	EX3620 NEGRO MATE (EXPEMPCFNM+3600N-35NM+KXB20NM+CLEANM)
ALEXIA	EX3620NC	MKX305362	EX3620 NIQUEL CEPILLADO (EXPEMPCFNC+3600N-35NC+KXB20NC+CLEANC)
ALEXIA	EX3620OC	MKX303493	EX3620 ORO CEPILLADO (EXPEMPCFOC+3600N-35OC+KXB20OC+CLEAOC)
KUATRO	EX4720	MKX301553	EX4720 (EXPEMPCF+4700N-35+KB20+CLEK)
KUATRO NK	EX4920	MKX301554	EX4920 (EXPEMPCF+4900N-35+KB20+CLEK)
TZAR	EX342001	MKX302942	EX342001 (EXPEMPCF+3400N-35+KXB20+CLEA)
TZAR	EX342001NM	MKX303491	EX342001 NEGRO MATE (EXPEMPCFNM+3400N-35NM+KXB20NM+CLEANM)
TZAR	EX342001NC	MKX304987	EX342001 NIQUEL CEPILLADO (EXPEMPCFNC+3400N-35NC+KXB20NC+CLEANC)
TZAR	EX342001OC	MKX305017	EX342001 ORO CEPILLADO (EXPEMPCFOC+3400N-35OC+KXB20OC+CLEAOC)
URBAN CHIC	EX212001	MKX302941	EX212001 CROMO (EXPEMPCF+2100N-35+KXB20+CLEU)



1VÍA

EXPEMPMM		MKX301467	Expositor cromo empotrado monomando
EXPEMPMMOC		MKX303285	EXPOSITOR ORO CEPILLADO EMP. MONOMANDO
EXPEMPMMNM		MKX303286	EXPOSITOR NEGRO MATE EMP. MONOMANDO
EXPEMPMMNC		MKX304001	EXPOSITOR NIQUEL CEPILLADO EMP. MONOMANDO
ADAGIO	EX911801	MKX306838	EX911801 CROMO (EXPEMPMM02+9100N-35+KX1)
ADAGIO	EX911801NM	MKX306839	EX911801NM NEGRO MATE (EXPEMPMM02NM+9100N-35NM+KX1NM)
ADAGIO	EX911801OC	MKX306840	EX911801OC ORO CEPILLADO (EXPEMPMMOC+9100N-35OC+KX1OC)
ALEXIA	EX361801	MKX301507	EX361801 CROMO (EXPEMPMM+3600N-35+KX1)
ALEXIA	EX361801NM	MKX303969	EX361801 NEGRO MATE (EXPEMPMMNM+3600N-35NM+KX1NM)
ALEXIA	EX361801NC	MKX303975	EX361801 NIQUEL CEPILLADO (EXPEMPMMNC+3600N-35NC+KX1NC)
ALEXIA	EX361801OC	MKX303280	EX361801 ORO CEPILLADO (EXPEMPMMOC+3600N-35OC+KX1OC)
URBAN CHIC	EX211801	MKX302948	EX211801 CROMO (EXPEMPMM+2100N-35+KU1)
URBAN CHIC	EX211801NC	MKX306692	EX211801NC NIQUEL CEPILLADO (EXPEMPMMNC+2100N-35NC+KU1NC)
URBAN CHIC	EX211801OC	MKX306921	EX211801OC ORO CEPILLADO (EXPEMPMMOC+2100N-35OC+KU1OC)
AQUANOVA FLY	EX551801	MKX301515	EX551801 (EXPEMPMM+5500N-35+R1)
ÁTICA	EX751801	MKX301508	EX751801 (EXPEMPMM+7500N-35+KX1)
DRAKO	EX331801	MKX301510	EX331801 (EXPEMPMM+3300N-35+KX1)
KUATRO	EX471801	MKX301511	EX471801 (EXPEMPMM+4700N-35+K1)
KUATRO NK	EX491801	MKX301512	EX491801 (EXPEMPMM+4900N-35+K1)
NEW FLY	EX571801	MKX303996	EX571801 CROMO (EXPEMPMM+5700N-35+KX1)
NEW FLY	EX571801NM	MKX305363	EX571801 NEGRO MATE (EXPEMPMMNM+5700N-35NM+KX1NM)
RS-Q	EX931801	MKX301509	EX931801 (EXPEMPMM+9400N-35+KX1)
TITANIUM	EX181801	MKX301517	EX181801 (EXPEMPMM+1800N-35+R1)
TZAR	EX341801	MKX302949	EX341801 CROMO (EXPEMPMM+3400N-35+KU1)
TZAR	EX341801NM	MKX303281	EX341801 NEGRO MATE (EXPEMPMMNM+3400N-35NM+KU1NM)
TZAR	EX341801OC	MKX303968	EX341801 ORO CEPILLADO (EXPEMPMMOC+3400N-35OC+KU1OC)
VULCANO	EX691801	MKX301516	EX691801 (EXPEMPMM+6900N-35+R1)
YPSILON	EX661801	MKX301513	EX661801 EXPEMPMM+6600N-35+KX1)
YPSILON PLUS	EX641801	MKX301514	EX641801 (EXPEMPMM+6400N-35+KX1)
	EX601801	MKX301518	EX601801 (EXPEMPMM+6000N-35+R1)



2VÍAS

ADAGIO	EX911512	MKX306821	EX911512 CROMO (EXPEMP2V02+9100N-35+915001+KX2)
ADAGIO	EX911512NM	MKX306822	EX911512NM NEGRO MATE (EXPEMP2V02NM+9100N-35NM+915001NM+KX2NM)
ADAGIO	EX911512OC	MKX306823	EX911512OC ORO CEPILLADO (EXPEMP2V02OC+9100N-35OC+915001OC+KX2OC)
URBAN	EX211502	MKX302945	EX211502 CROMO (EXPEMP2V+2100N-35+215100+KU2)
URBAN	EX211502OC	MKX306768	EX211502OC ORO CEPILLADO (EXPEMP2VOC+2100N-35OC+215100OC+KU2OC)
ALEXIA	EX361502	MKX301520	EX361502 CROMO (EXPEMP2V+3600N-35+365100+KX2)
ALEXIA	EX361502NM	MKX303284	EX361502 NEGRO MATE (EXPEMP2VNM+3600N-35NM+365100NM+KX2NM)
ALEXIA	EX361502OC	MKX303403	EX361502 ORO CEPILLADO (EXPEMP2VOC+3600N-35OC+365100OC+KX2OC)
ÁTICA	EX751502	MKX301521	EX751502 (EXPEMP2V+7500N-35+945100+KX2)
BLAUTHERM	EX941502	MKX302003	EX941502 (EXPEMP2V+940001N-35+945100+KX2)
BLAUTHERM	EX941502RK250	MKX303253	EX941502 RK250 (EX941502K+B350+RK250+4713P+4796+2471C)



BLAUTHERM	EX-941502RPK225	MKX302006	EX941502 RPK225 (EX941502K+BNRPK225+4713P+4796+2471C)
BLAUTHERM	EX941502RP240	MKX302005	EX941502 RP240 (EX941502+BHRP240+2876BT+3796+2471C)
BLAUTHERM	EX941502K	MKX302004	EX941502K (EXPEMP2V+940001N-35+945100+K2)
BLAUTHERM	EX948712RK250	MKX303255	EX948712 RK250 (EX948712K+RK250+B350+4713P+4796+2471C)
BLAUTHERM	EX941502RP240	MKX302005	EX941502 RP240 (EX941502+BHRP240+2876BT+3796+2471C)
BLAUTHERM	EX-948712RPK225	MKX302955	EX948712 RPK225 (EX948712K+BNRPK225+4713P+4796+2471C)
BLAUTHERM	EX 941502 RM250	MKX303216	EX941502 RM250 (EX941502+BHRM250+2876BT+3796+2471C)
DRAKO	EX331502	MKX301523	EX331502 (EXPEMP2V+3300N-35+335100+KX2)
KUATRO	EX471502	MKX301524	EX471502 (EXPEMP2V+4700N-35+475100+K2)
KUATRO NK	EX491502	MKX301525	EX491502 (EXPEMP2V+4900N-35+475100+K2)
TITANIUM	EX181502	MKX301530	EX181502 (EXPEMP2V+1800N-35+945100+R2)
NEW FLY	EX571502	MKX303997	EX571502 (EXPEMP2V+5700N-35+945100+KX2)
NEW FLY	EX571502NM	MKX304407	EX571502 NEGRO MATE (EXPEMP2VNM+5700N-35NM+945100NM+KX2NM)
RS-Q	EX931502	MKX301522	EX931502 (EXPEMP2V+9400N-35+945100+KX2)
TZAR	EX341502	MKX302946	EX341502 (EXPEMP2V+3400N-35+345100+KU2)
TZAR	EX341502NM	MKX303290	EX341502 NEGRO MATE (EXPEMP2VNM+3400N-35NM+345100NM+KU2NM)
TZAR	EX341502NC	MKX303970	EX341502 NIQUEL CEPILLADO (EXPEMP2VNC+3400N-35NC+345100NCKU2NC)
TZAR	EX341502OC	MKX303974	EX341502 ORO CEPILLADO (EXPEMP2VOC+3400N-35OC+345100NCKU2OC)
TITANIUM	EX181502	MKX301530	EX181502 (EXPEMP2V+1800N-35+945100+R2)
YPSILON	EX661502	MKX301526	EX661502 (EXPEMP2V+6600N-35+945100+KX2)
YPSILON PLUS	EX641502	MKX301527	EX641502 (EXPEMP2V+6400N-35+945100+KX2)



## 3VÍAS



EXPEMP3V	MKX301885	Expositor cromo distribuidor 3vias	
ALEXIA	EX361503	MKX301532	EX361503 CROMO (EXPEMP3V+3600N-35+365100+KX3)
ALEXIA	EX361503NC	MKX303967	EX361503 NIQUEL CEPILLADO (EXPEMP3VNC+3600N-35NC+365100NC+KX3NC)
ÁTICA	EX751503	MKX301533	EX751503 (EXPEMP3V+7500N-35+945100+KX3)
DRAKO	EX331503	MKX301535	EX331503 (EXPEMP3V+3300N-35+335100+KX3)
KUATRO	EX471503	MKX301536	EX471503 (EXPEMP3V+4700N-35+475100+K3)
KUATRO NK	EX471503	MKX301537	EX491503 (EXPEMP3V+4900N-35+475100+K3)
RS-Q	EX931503	MKX301534	EX931503 (EXPEMP3V+9400N-35+945100+KX3)
TZAR	EX341503	MKX301535	EX341503 (EXPEMP3V+3400N-35+345100+KU3)
URBAN CHIC	EX471503	MKX301536	EX211503 CROMO (EXPEMP3V+2100N-35+215100+KU3)
YPSILON	EX661503	MKX301538	EX661503 (EXPEMP3V+6600N-35+945100+KX3)
YPSILON PLUS	EX641503	MKX301539	EX931503 (EXPEMP3V+9400N-35+945100+KX3)

## DUMMIES SIN CUERPOS EMPOTRADOS TERMOSTÁTICOS

## DUMMIES WITHOUT THERMOSTATIC CONCEALED BODIES



1 VÍA

EXPEMPT		MKX302807	EXPOSITOR NEUTRO EMPOTRADO TERMOSTATICO
ADAGIO	EX912421	MKX306841	EX912421 CROMO (EXPEMPT02+915000+915000ML+KTX1)
ADAGIO	EX912421NM	MKX306842	EX912421NM NEGRO MATE (EXPEMPT02NM+915000NM+915000MLNM+KTX1NM)
ADAGIO	EX912421OC	MKX306843	EX912421OC ORO CEPILLADO (EXPEMPT02OC+915000OC+915000MLOC+KTX1OC)
ALEXIA	EX362411	MKX301859	EX362411 (EXPEMPT+365000+365100+KTX1)
AROLA	EX262411	MKX302601	EX262411 (EXPEMPT+265000+265100+KTU1)
BLAUTHERM	EX942411	MKX302907	EX942411 (EXPEMPT+945000+945100+KTX1)
DRAKO	EX332411	MKX302929	EX332411 (EXPEMPT+335000+335100+KTX1)
KUATRO	EX472411	MKX302927	EX472411 (EXPEMPT+475000+475100+KT1)
RS-CROSS	EX622411	MKX302926	EX622411 (EXPEMPT+625000+625100+KTX1)
TZAR	EX342411	MKX302935	EX342411 (EXPEMPT+345000+345100+KTU1)
URBAN CHIC	EX212411	MKX302933	EX212411 (EXPEMPT+215000+215100+KTU1)
	EX302411	MKX302931	EX302411 (EXPEMPT+305000+305100+KTX1)

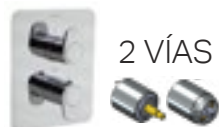

2 VÍAS

EXPEMP	EXPEMP2V	MKX301468	EXPEMP2V CROMO EXPOSITOR DISTRIBUIDOR 2 VIAS
EXPEMPT		MKX302807	EXPOSITOR NEUTRO EMPOTRADO TERMOSTATICO
ADAGIO	EX918722	MKX306850	EX918722 CROMO (EXPEMPT02+915000+915000ML+KTX2)
ADAGIO	EX918722NM	MKX306851	EX918722NM NEGRO MATE (EXPEMPT02NM+915000NM+915000MLNM+KTX2NM)
ADAGIO	MKX306852	EX918722OC	EX918722OC ORO CEPILLADO (EXPEMPT02OC+915000OC+915000MLOC+KTX2OC)
ALEXIA	EX368712	MKX302034	EX368712 CROMO (EXPEMPT+365000+365100+KTX2)
ALEXIA	EX368712NM	MKX304327	EX368712 NEGRO MATE (EXPEMPTNM+365000NM+365100NM+KTX2NM)
ALEXIA	EX368712OC	MKX303657	EX368712 ORO CEPILLADO (EXPEMPTOC+365000OC+365100OC+KTX2OC)
AROLA	EX268712	MKX302925	EX268712 (EXPEMPT+265000+265100+KTU2)
BLAUTHERM	EX948712	MKX302906	EX948712 (EXPEMPT+945000+945100+KTX2)
BLAUTHERM	EX948712K	MKX302953	EX948712K (EXPEMPT+945000+945100+KT2)
DRAKO	EX338712	MKX302930	EX338712 (EXPEMPT+335000+335100+KTX2)
KUATRO	EX478712	MKX302939	EX478712 (EXPEMPT+475100+475000+KT2)
RS-CROSS	EX628712	MKX302928	EX628712 (EXPEMPT+625100+625000+KTX2)
TZAR	EX348712	MKX302936	EX348712 CROMO (EXPEMPT+345000+345100+KTU2)°
TZAR	EX348712NM	MKX304328	EX348712 NEGRO MATE (EXPEMPTNM+345000NM+345100NM+KTU2NM)
TZAR	EX338712	MKX305371	EX348712 ORO CEPILLADO (EXPEMPTOC+345000OC+345100OC+KTU2OC)
KUATRO	EX478712	MKX302939	EX478712 (EXPEMPT+475100+475000+KT2)
URBAN CHIC	EX218712	MKX302934	EX218712 CROMO (EXPEMPT+215000+215100+KTU2)
	EX308712	MKX302932	EX308712 (EXPEMPT+305000+305100+KTX2)

# KIT TERMOSTÁTICOS 3 VOLANTES CON INVERSOR 3 VÍAS

## THREE HANDLE THERMOSTATIC KIT WITH TWIN INVERTER

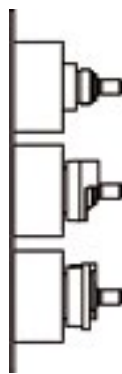
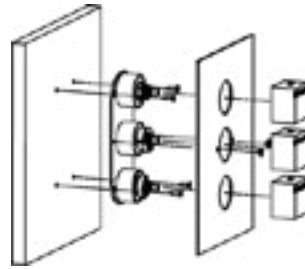

4210710

K23



- 3651 + 3655 + 3653
- 3351 + 3352 + 3353
- 9351 + 9353 + 9360
- 6251 + 6252 + 6253

**ALEXIA**  
**DRAKO**  
**RS-Q**  
**RS-CROSS**

EX3627 MKX301756  
EX3327 230883  
EX9327 260547  
EX6227 300299

KL23



- 2651 + 2655 + 2653

**AROLA**

EX2627 230874

KK23



- 4752 + 4752 + 4752

**KUATRO**

EX4723 230856

# DUMMIES SIN CUERPOS BIMANDO REPISA

## DUMMIES WITHOUT THERMOSTATIC CONCEALED BODIES



ADAGIO	EX914201	MKX307545	EX914201 CROMO LAVABO REPISA 5L ADAGIO CAÑO 170mm
ADAGIO	EX914202	MKX307547	EX914202 CROMO LAVABO REPISA 5L ADAGIO CAÑO 190mm
ADAGIO	EX914202ML	MKX307548	EX914202ML CROMO LAVABO REPISA 5L ADAGIO CAÑO 190mm
ADAGIO	EX914201ML	MKX307532	EX914201ML CROMO LAVABO REPISA 5L ADAGIO CAÑO 170mm
ADAGIO	EX914201NM	MKX307549	EX914201NM NEGRO MATE LAVABO REPISA 5L ADAGIO CAÑO 170mm
ADAGIO	EX914202NM	MKX307550	EX914202NM NEGRO MATE LAVABO REPISA 5L ADAGIO CAÑO 190mm
ADAGIO	EX914201MLNM	MKX307551	EX914201MLNM NEGRO MATE LAVABO REPISA 5L ADAGIO CAÑO 170mm
ADAGIO	EX914202MLNM	MKX307552	EX914202MLNM NEGRO MATE LAVABO REPISA 5L ADAGIO CAÑO 190mm
ADAGIO	EX914201OC	MKX307553	EX914201OC ORO CEPILLADO LAVABO REPISA 5L ADAGIO CAÑO 170mm
ADAGIO	EX914202OC	MKX307554	EX914202OC ORO CEPILLADO LAVABO REPISA 5L ADAGIO CAÑO 190mm
ADAGIO	EX914201MLOC	MKX307556	EX914201MLOC ORO CEPILLADO LAVABO REPISA 5L ADAGIO CAÑO 170mm
ADAGIO	EX914202MLOC	MKX307557	EX914202MLOC ORO CEPILLADO LAVABO REPISA 5L ADAGIO CAÑO 190mm



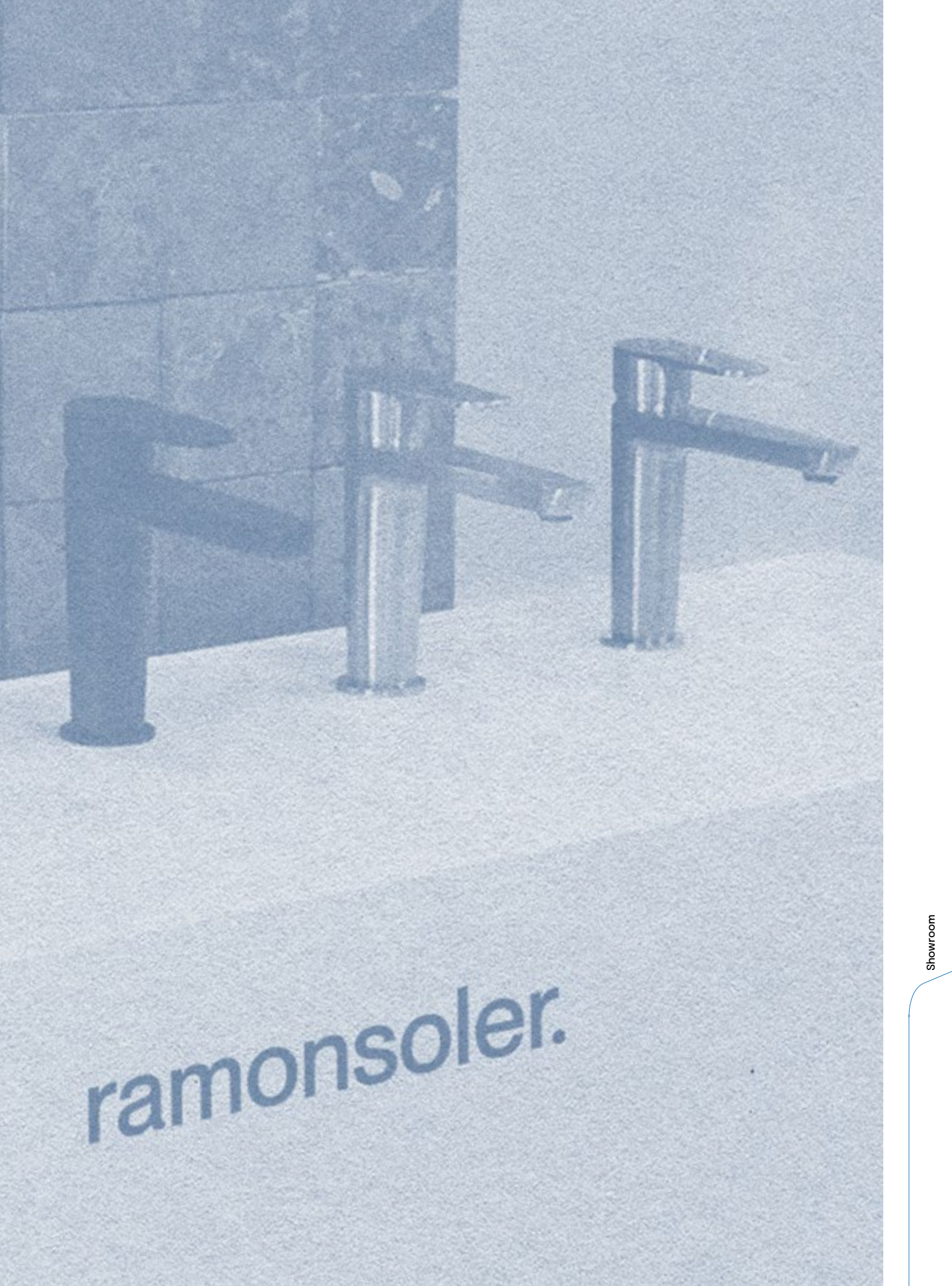

ramonsoler.

Renove  
Renove

ramonsoler.



ALEXIA  
DRAKO  
ÂTICA  
RS-Q  
RS-CROSS  
BLAUTHERM

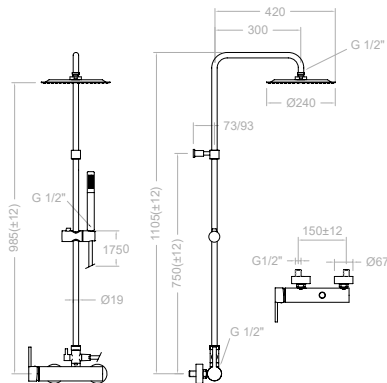

**3347RP240**  
257991

441,10 €

Columna de ducha fija monomando rociador ø 240 mm.  
Single lever fix shower column , chrome abs headshower ø 240 mm.



Cartucho Cartridge: 40200 (3388KC2)

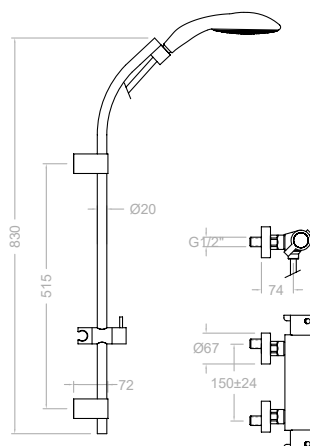

**339502MS**  
33D301945

460,50 €

Conjunto termostático de ducha con barra de latón y equipo de ducha.  
Thermostatic shower with bar and chrome shower accessories.



Cartucho Cartridge: 1701T + 1700C 1/2

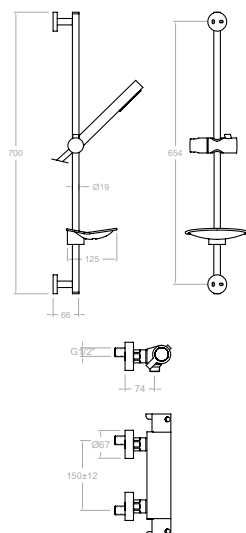

**339303AS**  
33D301899

359,80 €

Conjunto termostático de ducha con barra y equipo de ducha.  
Thermostatic shower set with slide bar and shower set.



Cartucho Cartridge: 1701T + 1700C 1/2



**3358RM250**  
257928

669,80 €

Columna de ducha telescópica monomando rociador metálico ø 250 mm.  
Single lever telescopic shower column, chrome metallic headshower ø 250 mm

Cartucho Cartridge: 40200 (3388KC2)

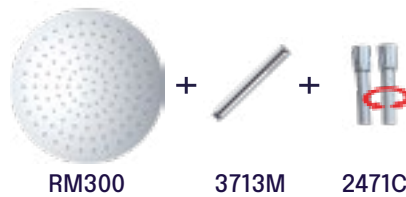

RM300

3713M

2471C

**3358RM300**  
257937

726,50 €

Ducha.  
Shower.

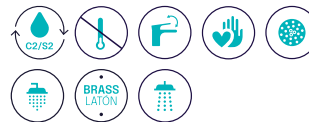

3308S + DN130 +IDH 1/2+RM300+3713M+2471C



RPK225

3713P

2471C

**3358RPK225**  
257919

538,80 €

Ducha.  
Shower.

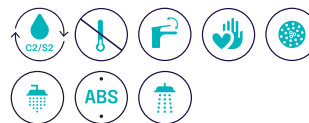

3308S+DN130 +IDH1/2+RPK225+3713P+2471C

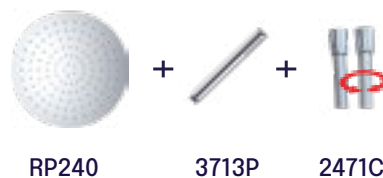

RP240

3713P

2471C

**3358RP240**  
257910

531,30 €

Ducha.  
Shower.



3308S + DN130 +IDH 1/2+RP240+3713P+2471C

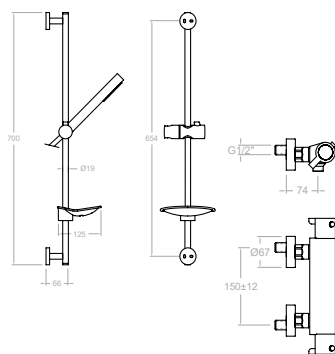

**339403T3**

33D301900

352,60 €

Conjunto termostático de ducha con barra y equipo de ducha.  
Thermostatic shower with slide bar and shower set.



Cartucho Cartridge: 1701T + 1700C 1/2

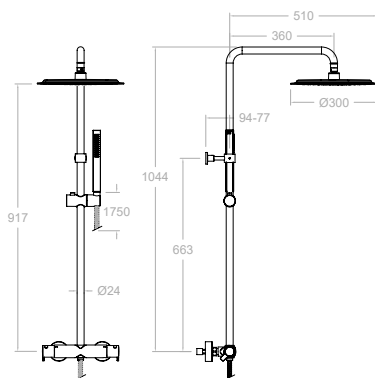

**334803RP300**

33D303741

583,50 €

Columna de ducha fija termostática rociador ø 300 mm.  
Thermostatic Fix Shower column, chrome ABS headshower ø 300 mm.



**331203S**

33D303732

256,60 €

Termostático de ducha.  
Thermostatic shower chrome.

Cartucho Cartridge: 1701T + 4000

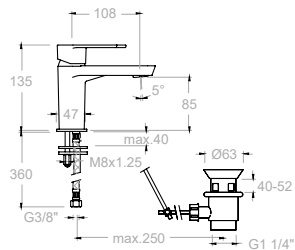
**360102**

36A303691

93,40 €

**Monomando de lavabo (S).**  
High washbasin mixer (S).

**360102VA9065**

104,50 €

36A303687

**Monomando de lavabo (S) con válvula automática 1/4\"**  
High washbasin mixer (S) with pop-up waste 1/4\".

Ref. 9065 ABS

Cartucho Cartridge: 35100-3

**360102VA1169**

112,90 €

36A303686

**Monomando de lavabo (S) con válvula automática 1/4\"**  
High washbasin mixer (S) with pop-up waste 1/4\".

Ref. 1169 INOX

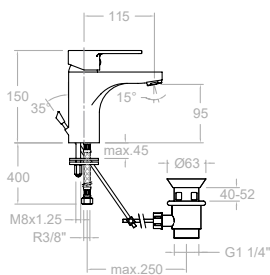

RS-Q

**930102**

93A300603

115,80 €

**Monomando de lavabo (M).**  
Washbasin mixer.

**930102VA1167**

139,60 €

93A300611

**Monomando de lavabo, con válvula automática 1/4\"**  
Washbasin mixer with pop-up waste 1/4\".

Ref. 1167

Cartucho Cartridge: 40100 (3388)

**930102VA1169**

134,80 €

93A301990

**Monomando de lavabo (M), con válvula automática 1/4\"**  
Washbasin mixer with stainless steel pop-up waste 1/4\".

Ref. 1169 INOX

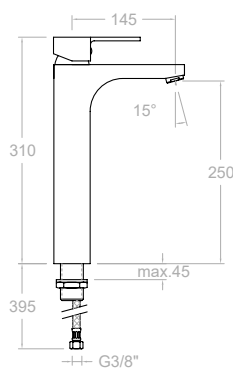
**9310**

330541

244,00 €

**Monomando de lavabo (L).**  
Washbasin mixer.

Cartucho Cartridge: 40301-3

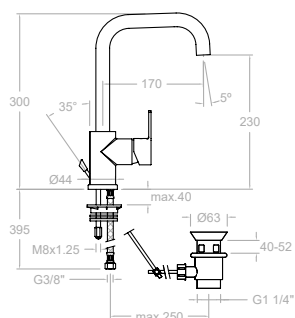
**931102**

93A301605

116,00 €

**Monomando de lavabo con caño giratorio.**  
Washbasin mixer with swivel spout.

**931102VA1167**

139,80 €

93A301606

**Monomando de lavabo caño giratorio con válvula automática de latón 1/4\"**  
Washbasin single lever with swivel spout and brass pop-up waste.

Ref. 1167

Cartucho Cartridge: 35200 (6689 C2)



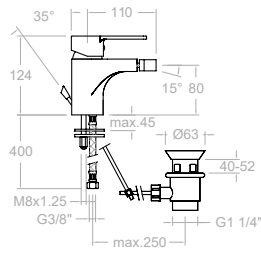

**9303**

227202

115,80 €

**Monomando de bidé.**

Bidet mixer.



**9303VA1167**

227220

139,60 €

**Monomando de bidé, y válvula automática, latón 1¼".**

Bidet mixer and pop up waste, brass 1¼".

Ref. 1167

Cartucho Cartridge: 40100 (3388)

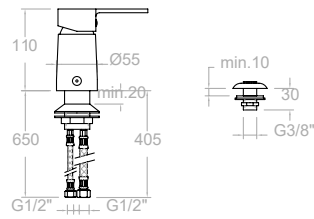

**SA9323**

230595

114,30 €

**Monomando para bidé de repisa con ducha.**

Single lever deck mounted bidet with shattaf.



Cartucho Cartridge: 40100 (3388)

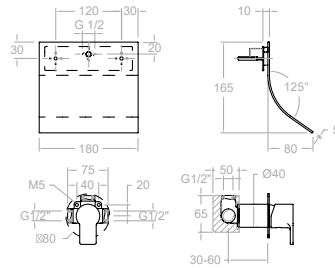

**93169**

93A300914

570,90 €

**Monomando de lavabo empotrado mural con caño cascada extraplano.**

Wall washbasin mixer with ultraslim cascade spout.



Cartucho Cartridge: 35100 (6689-2)

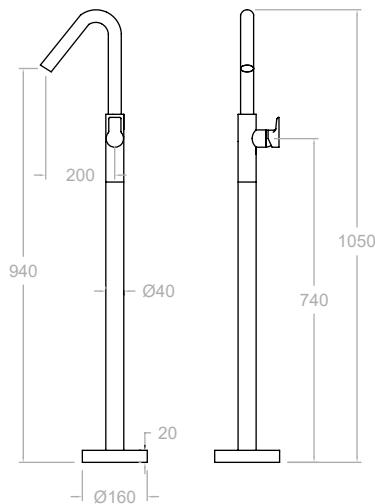

**937602S**

93A303374

865,80 €

**Columna de pie monomando lavabo.**

Single lever washbasin column mixer.



Cartucho Cartridge: 35100-2



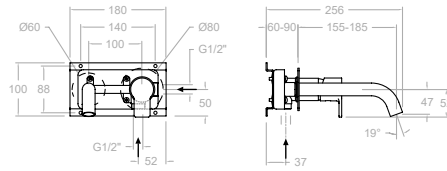

**932102**  
93A300687

249,50 €

Monomando de lavabo empotrado con caño de 19 cm.  
Concealed wash basin mixer with 19 cm spout.



**932103**  
93A301461

259,80 €

Monomando de lavabo empotrado con caño de 24 cm.  
Concealed wash basin mixer with 24 cm spout.

Cartucho Cartridge: 35100-2

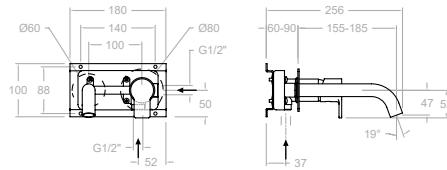

**932002**  
93A300689

249,50 €

Monomando de lavabo empotrado con caño de 19 cm.  
Concealed wash basin mixer with 19 cm spout.



**932003**  
93A301460

259,80 €

Monomando de lavabo empotrado con caño de 24 cm.  
Concealed wash basin mixer with 24 cm spout.

Cartucho Cartridge: 35100-2

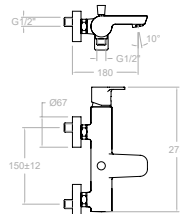

**930511S**  
93C306173

192,90 €

Monomando de baño-ducha sin equipo de ducha.  
Bath and shower mixer without shower kit.



**930511T1**  
93C306174

236,80 €

Monomando de baño-ducha con equipo de ducha.  
Bath and shower mixer with shower kit.

930511S + 3520T1+3726+2471C

**930511T3**  
93C306175

243,00 €

Monomando de baño-ducha con equipo de ducha.  
Bath and shower mixer with shower kit.

930511S + 5840T3+3726+2471C

Cartucho Cartridge: 35100 (6689-2)

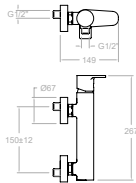

**930811S**  
93D306176

133,40 €

Monomando de ducha sin equipo de ducha.  
Shower mixer without shower kit.



**T1**



**930811T1**  
93D306177

177,30 €

Monomando de ducha con equipo de ducha.  
Shower mixer with shower kit.

930811S + 3520T1+3726+2471C

**T3**



**930801T3**  
93D306178

183,40 €

Monomando de ducha con equipo de ducha.  
Shower mixer with shower kit.

Cartucho Cartridge: 35100-3

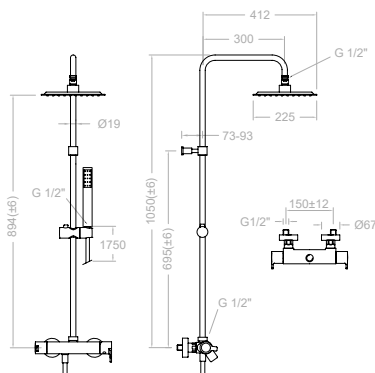

**937802RPK225**  
94D304365

442,00 €

932802S+T100N+RPK225+4713P+1128C

Conjunto monomando de gran ducha e inversor integrado, ABS accesorios.

Single lever shower mixer with integrated diverter, ABS accesorios.



Cartucho Cartridge: 35100 (6689-2) + 4004

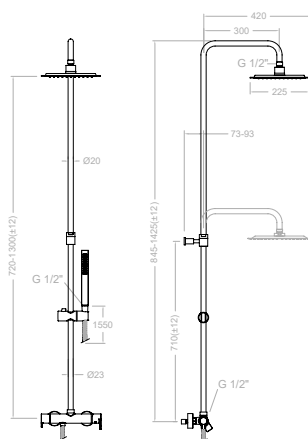

**937402RPK225**  
94D303895

484,80 €

932802S+DNI30+RPK225+4713P+1128C

Conjunto monomando de gran ducha e inversor integrado, con columna telescópica, ABS accesorios.

Single lever adjustable height shower mixer with integrated diverter, ABS accesorios.



Cartucho Cartridge: 35100 (6689-2) + 4004





1 Vía/Way

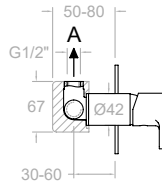
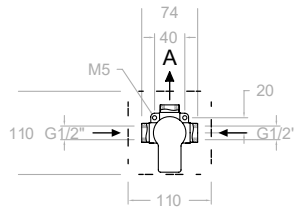

**931801S**  
93D300658

115,30 €

Monomando de ducha empotrado 1 vía con placa metálica.  
Single lever concealed mixer 1 way with ultraslim metallic plate.

XX1801	1bar	3bar	5bar
A l/min	17	26	34

Kit de ampliación - Extension set: KA1V



Cartucho Cartridge: 35100 (6689-2)



2 Vías/Ways

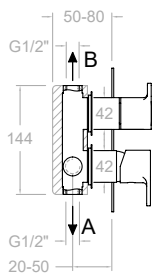
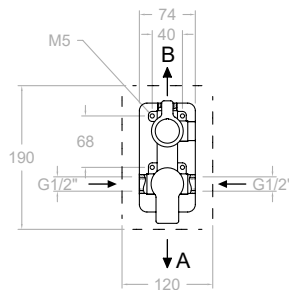

**931502S**  
93C300659

209,40 €

Monomando de ducha empotrado 2 vías con placa metálica.  
Single lever concealed mixer 2 ways with ultraslim metallic plate.

XX1502	1bar	3bar	5bar
A l/min	14	24	30
B l/min	13	22	29

Kit de ampliación - Extension set: KA2V



Cartucho Cartridge: 35100 (6689-2) + 4004



3 Vías/Ways

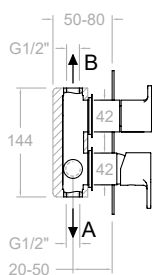
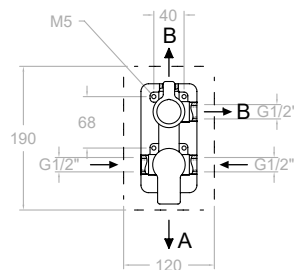

**931503S**  
93C300660

230,70 €

Monomando de ducha empotrado 3 vías con placa metálica.  
Single lever concealed mixer 3 ways with ultraslim metallic plate.

XX1503	1bar	3bar	5bar
A l/min	14	22	28
B l/min	13	21	26
B l/min	13	21	26

Kit de ampliación - Extension set: KA3V



Cartucho Cartridge: 35100 (6689-2) + 4003

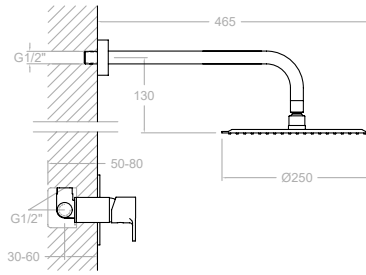

**K9318012**  
93D301377

347,00 €

Conjunto monomando empotrado 1 vía con rociador metálico  
ø 250 mm.  
Shower set with concealed single lever 1 way mixer, metallic  
headshower ø 250 mm.



Cartucho Cartridge: 35100 (6689-2)

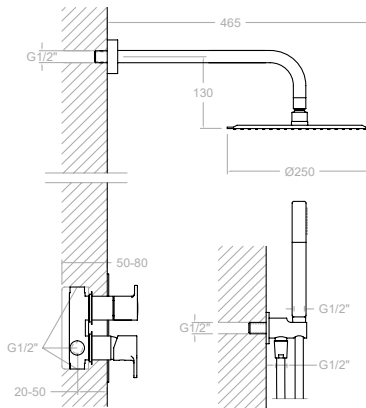

**K9315021**  
93C301378

551,60 €

Conjunto monomando empotrado 2 vías con soporte,  
toma de agua, teleducha y rociador metálico mural ø 250 mm.  
Shower set with concealed single lever 2 ways mixer, water  
outlet, handshower, metallic headshower ø 250 mm.



Cartucho Cartridge: 35100 (6689-2)+4004



1 Vía/Way

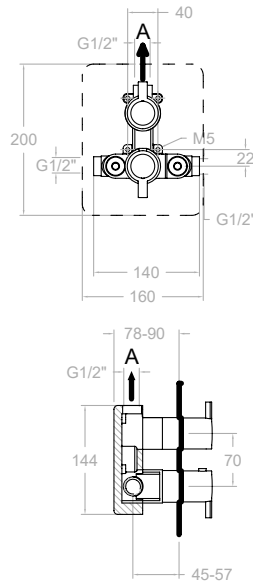

**932411S**  
93D302532

187,50 €

Termostático de ducha empotrado 1 vía con placa metálica.  
Thermostatic concealed mixer 1 way with ultraslim metallic plate.

XX2411S	1bar	3bar	5bar
A l/min	17	26	31

Kit de ampliación - Extension set: KAET104

Cartucho Cartridge: 1703T + 1700C3/4"



2 Vías/Ways

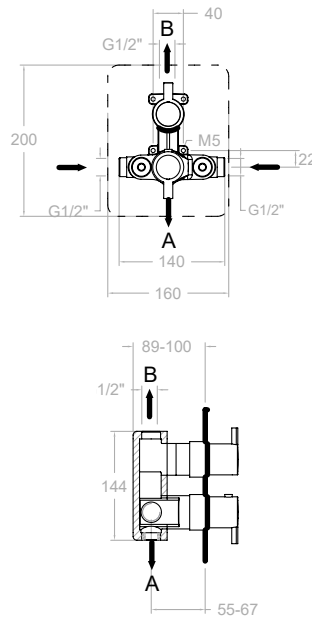

**938712S**  
93D302541

257,00 €

Termostático de baño-ducha empotrado 2 vías con placa metálica extraplana.  
Thermostatic concealed mixer 2 ways with ultraslim metallic plate.

XX8712	1bar	3bar	5bar
A l/min	14	24	30
B l/min	13	22	28

Kit de ampliación - Extension set: KAET103

Cartucho Cartridge: 1703T + 4000



3 Vías/Ways

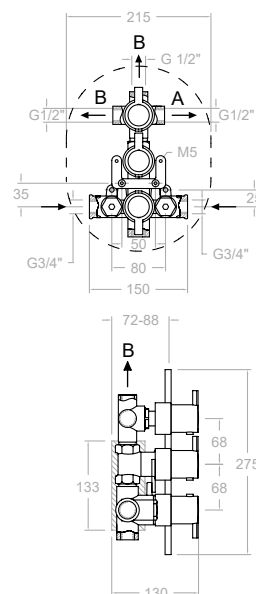

**9327S**  
251520

727,60 €

Termostático de baño-ducha empotrado 3 vías con placa metálica extraplana.  
Thermostatic concealed mixer 3 ways with ultraslim metallic plate.

ETDI	CARTUCHO GRAN CAUDAL 1700 TE		
	1 bar	3 bar	5 bar
A (Baño)	13,5	23,3	30,2
B (Baño)	9,3	15,5	19,2

Kit de ampliación - Extension set: KAETDI

Cartucho Cartridge: 1700TE + 1700C3/4" + 1000I



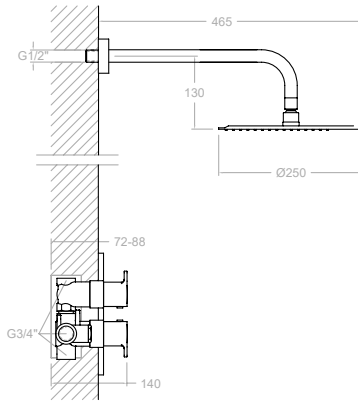

**K9324012**  
93D302751

419,10 €

Conjunto termostático empotrado 1 vía con rociador metálico  
Ø 250 mm.

Shower set with thermostatic 1 way mixer, water outlet,  
handshower, metallic headshower Ø 250 mm.



Cartucho Cartridge: :1700TE + 1700C 3/4

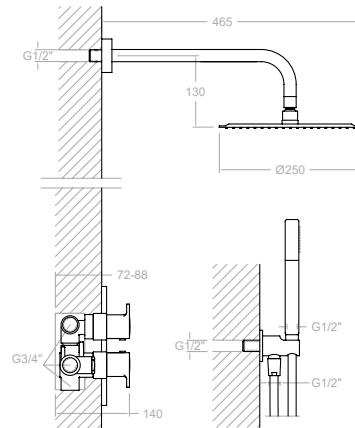

**K9387011**  
93D302756

599,20 €

Conjunto monomando empotrado 2 vías con soporte,  
toma de agua, teleducha y rociador metálico mural Ø 250 mm.

Shower set with concealed single lever 2 ways mixer, water  
outlet, handshower, metallic headshower Ø 250 mm.



Cartucho Cartridge: 1703T + 4000



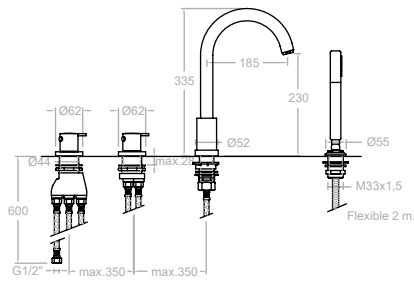

**933303TM**  
93C301666

909,20 €

Termostático de baño-ducha de repisa con equipo de ducha metálico.  
Thermostatic deck-mounted bath shower mixer with metallic shower set.

Cartucho Cartridge: 1700 TE + 4000

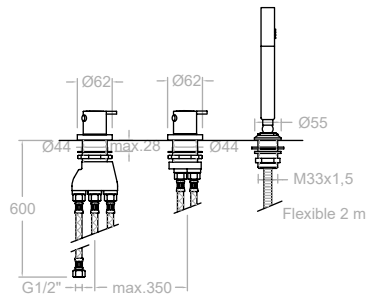

**9333TSCAM**  
255903

642,80 €

Termostático de ducha de repisa con equipo de ducha metálico.  
Thermostatic deck-mounted shower mixer.

Cartucho Cartridge: 1700 TE + 4000

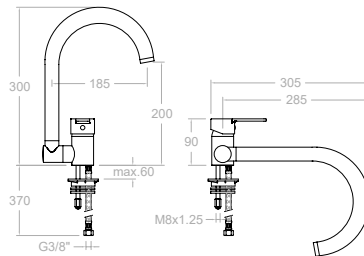

**9369**  
227346

213,20 €

Monomando para fregadero con caño abatible.  
Sink mixer with swivel and folding spout.

Cartucho Cartridge: 40100-2 (3388-2)

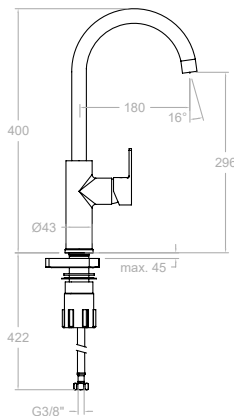

**930602**  
93E301609

149,00 €

Monomando para fregadero con caño giratorio.  
Sink mixer with swivel spout.

Cartucho Cartridge: 35100



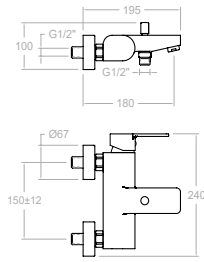

**9305S**  
227274

192,90 €



Monomando de baño - ducha sin equipo de ducha.  
Bath and shower mixer without shower kit.



**9305T1**  
258801

236,80 €

Monomando de baño - ducha con equipo de ducha.  
Bath and shower mixer with shower kit.

9305S + 3520 T1 + 3726 + 2471C

**9305T3**  
259647

243,00 €

9305S + 5840T3 + 3726 + 2471C

Monomando de baño - ducha con equipo de ducha.  
Bath and shower mixer with shower kit.

Cartucho Cartridge: 40100 (3388)

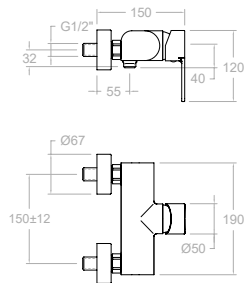

**9308S**  
227256

133,40 €



Monomando de baño - ducha sin equipo de ducha.  
Bath and shower mixer without shower kit.



**9308T1**  
258810

177,30 €

Monomando de baño - ducha con equipo de ducha.  
Bath and shower mixer with shower kit.

9308S + 3520 T1 + 3726 + 2471C

**9308T3**  
259656

183,40 €

9308S + 5840T3 + 3726 + 2471C

Monomando de baño - ducha con equipo de ducha.  
Bath and shower mixer with shower kit.

Cartucho Cartridge: 40100 (3388)

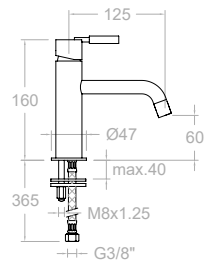

**7501**  
251574

156,50 €

**Monomando de lavabo (S).**  
High wash basin mixer (S).



Cartucho Cartridge: 25000-2 (4750)

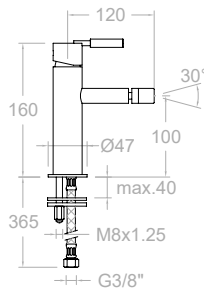

**7503**  
251601

153,40 €

**Monomando de bidé.**  
Bidet Mixer.



Cartucho Cartridge: 25000-2 (4750)

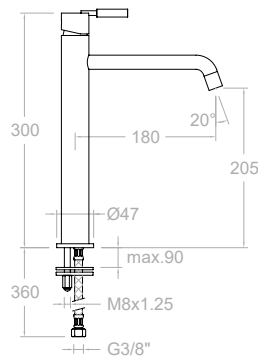

**7510**  
251583

205,30 €

**Monomando de lavabo (L).**  
High wash basin mixer (L).



Cartucho Cartridge: 25000-2 (4750)

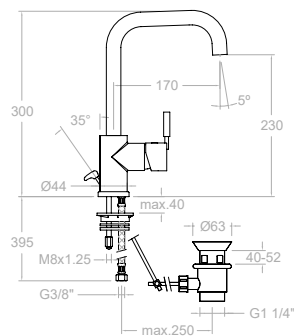

**7511**  
261904

146,90 €

**Monomando de lavabo con caño giratorio.**  
Washbasin mixer with swivel spout.



**7511VA1167**  
300087

170,90 €

**Monomando de lavabo, de caño alto giratorio, y válvula automática, latón 11/4".**  
Wash basin mixer with high swivel spout and pop up waste, brass. 1 1/4".

**Ref. 1167**

Cartucho Cartridge: 35200 (6689)

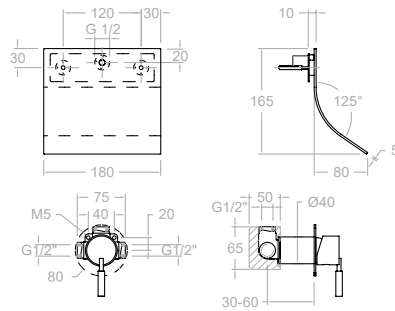

**75169**

75A300915

585,30 €

Monomando de lavabo empotrado mural con caño cascada extraplano.  
Wall washbasin mixer with ultraslim cascade spout.



Cartucho Cartridge: 35100 (6689-2)

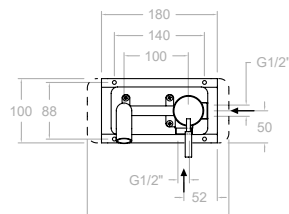

**7520**

75A300685

279,20 €

XX20CT+7500N-35+CLET+RB20

Monomando de lavabo empotrado con placa y caño de 19 cm.  
Concealed wash basin mixer with 19 cm spout.

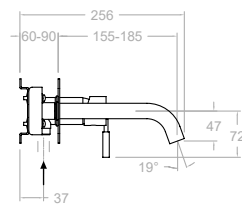

**752003**

75A301456

289,70 €

XX20CT+7500N-35+CLET24+RB20

Monomando de lavabo empotrado con placa y caño de 24 cm.  
Concealed wash basin mixer with 24 cm spout.

Cartucho Cartridge: 35100-2

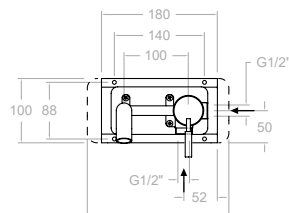

**752102**

75A300686

279,20 €

XX20CT+7500N-35+CLET+RB21H+RB21S

Monomando de lavabo empotrado con placa y caño de 19 cm.  
Concealed wash basin mixer with 19 cm spout.

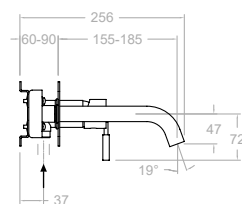

**752103**

75A301457

289,70 €

XX20CT+7500N-35+CLET24+RB21H+RB21S

Monomando de lavabo empotrado con placa y caño de 24 cm.  
Concealed wash basin mixer with 24 cm spout.

Cartucho Cartridge: 35100-2

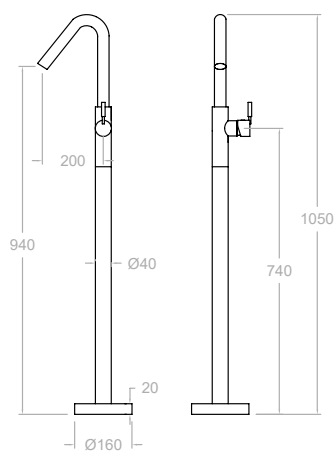

**757602S**  
75A303371

952,50 €

Monomando lavabo de columna.  
Washbasin column mixer.



Cartucho Cartridge: 35100-2

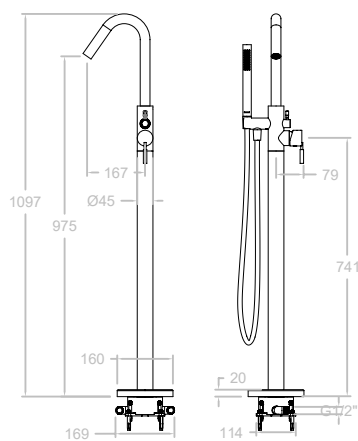

**758503S**  
75C303362

1.255,60 €

Columna monomando para bañera.  
Free standing bath shower column.



**758503MO**  
75C303363

1.361,80 €

Columna monomando para bañera con equipo de ducha.  
Free standing bath shower column with shower set.

Cartucho Cartridge: 35100-2

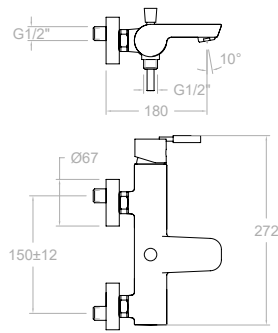

**750511S**  
75C306160

245,10 €

Monomando de baño - ducha sin equipo de ducha.  
Bath and shower mixer without shower set.



Cartucho Cartridge: 35100-2 (6689-2)



MO

**750511MO**  
75C306182

351,30 €

Monomando de baño - ducha con equipo de ducha metálico.  
Bath and shower mixer with shower set.



750511S + 3749 MO

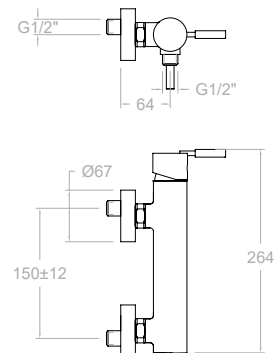

**750811S**  
75D306183

197,90 €

Monomando de baño - ducha sin equipo de ducha.  
Bath and shower mixer without shower set.



Cartucho Cartridge: 35100-3



MO

**750811MO**  
75D306184

304,10 €

Monomando de baño - ducha con equipo de ducha metálico.  
Bath and shower mixer with shower set.



750811S + 3749 MO

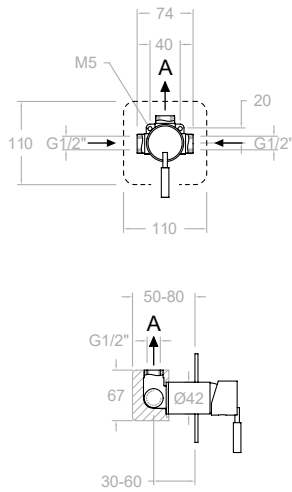

**751801S**  
75D300652

122,90 €

Monomando de ducha empotrado 1 vía con placa metálica.  
Single lever concealed mixer 1 way with ultraslim metallic plate.

XX1801	1bar	3bar	5bar
A l/min	17	26	31

Kit de ampliación - Extension set: KAIV



Cartucho Cartridge: 35100 (6689-2)

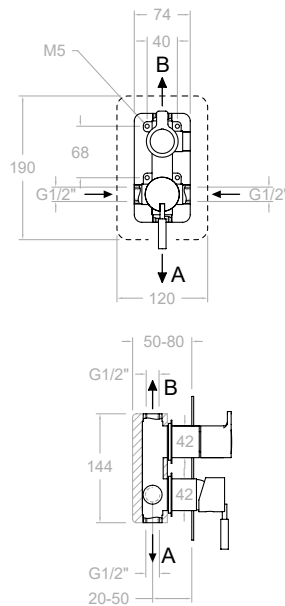

**751502S**  
75C300653

223,30 €

Monomando de ducha empotrado 2 vías con placa metálica.  
Single lever concealed mixer 2 ways with ultraslim metallic plate.

XX1502	1bar	3bar	5bar
A l/min	14	24	30
B l/min	13	22	29

Kit de ampliación - Extension set: KA2V



Cartucho Cartridge: 35100 (6689-2) + 4004

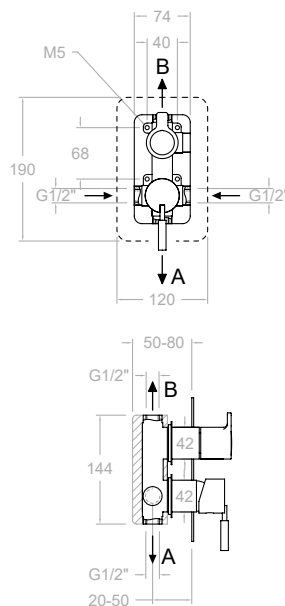

**9305T3**  
259647

243,00 €

Monomando de ducha empotrado 3 vías con placa metálica.  
Single lever concealed mixer 3 ways with ultraslim metallic plate.

XX1502	1bar	3bar	5bar
A l/min	14	22	28
B l/min	13	21	26
B l/min	13	21	26

Kit de ampliación - Extension set: KA3V



Cartucho Cartridge: 35100 (6689-2) + 4003



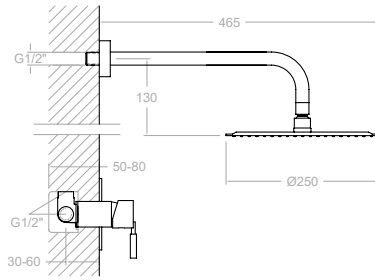

**K7518012**  
75D301374

354,50 €

Conjunto monomando empotrado 1 vía con rociador metálico ø 250 mm.  
Shower set with concealed single lever 1 way mixer, water outlet, handshower, metallic headshower ø 250 mm.



Cartucho Cartridge: :35100 (6689-2)

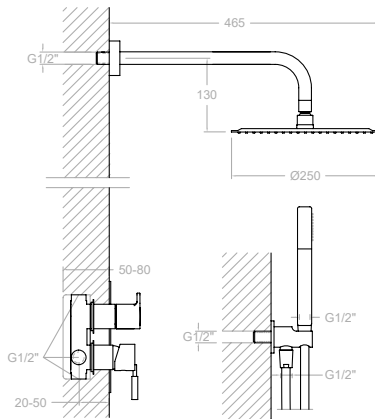

**K7515021**  
75C301375

565,50 €

Conjunto monomando empotrado 2 vías con soporte, toma de agua, teleducha y rociador metálico mural ø 250 mm.  
Shower set with concealed single lever 2 ways mixer, water outlet, handshower, metallic headshower ø 250 mm.



Cartucho Cartridge: 35100 (6689-2) -4004

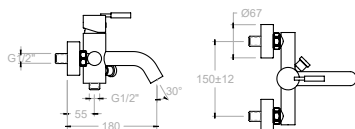

MO



**7505S**

251628

245,10 €

Monomando de baño - ducha sin equipo de ducha.  
Bath and shower mixer without shower set.



**7505MO**

251637

351,30 €

Monomando de baño - ducha con equipo de ducha metálico.  
Bath and shower mixer with shower set.

7505 S + 3749 MO

Cartucho Cartridge: 35000-2 (3760)

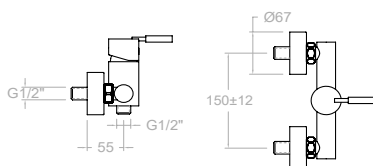

MO



**7508S**

251610

197,90 €

Monomando de baño - ducha sin equipo de ducha.  
Bath and shower mixer without shower set.



**7508MO**

251619

304,10 €

Monomando de baño - ducha con equipo de ducha metálico.  
Bath and shower mixer with shower set.

7508 S + 3749 MO

Cartucho Cartridge: 35000-2 (3760)

COCINAS KITCHEN

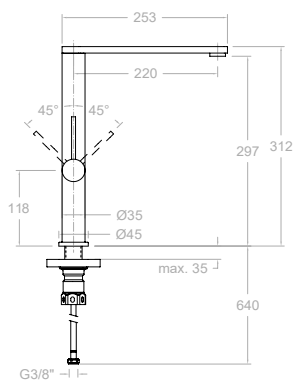

**3886**

38E301556

330,10 €

Fregadero caño alto giratorio.  
High swivel apout sink mixer.



Cartucho Cartridge: 25000-2

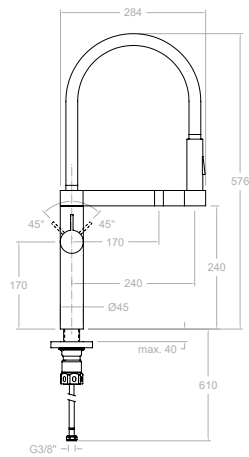

**388902**  
38E302693

653,60 €

Fregadero acero inoxidable profesional con circuito para agua purificada.

High swivel about sink mixer with circuit for purified water.



Cartucho Cartridge: 35100-2

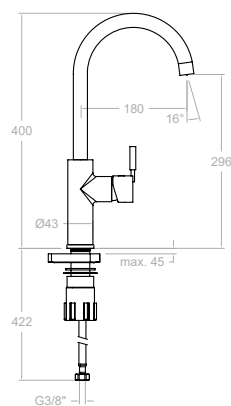

**750602**  
75E301595

151,20 €

Monomando para fregadero de caño giratorio alto.

Single lever kitchen mixer with high swivel spout.



Cartucho Cartridge: 35100 (6689-2)

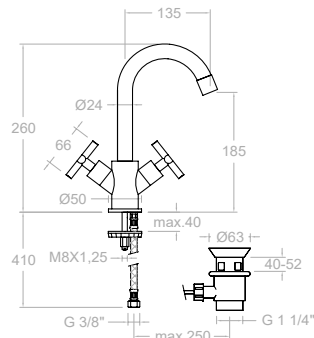

**6202** 252456 218,10 €

Bimando de lavabo con caño giratorio.  
Twin lever washbasin mixer with swivel spout.



**6202VA1167** 252483 242,40 €

Bimando de lavabo con caño giratorio y con válvula automática de latón 1/4".  
Twin lever washbasin mixer with swivel spout and automatic brass pop-up waste 1/4".

Ref. 1167

Montura Head: 1700C1/2"

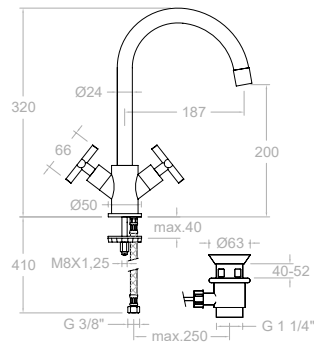

**6201** 252447 225,20 €

Bimando de lavabo con caño giratorio (L).  
Twin lever washbasin mixer with swivel spout (L).



**6202VA1167** 252474 249,30 €

Bimando de lavabo con caño giratorio y con válvula automática de latón 1/4" (L).  
Twin lever washbasin mixer with swivel spout and automatic brass pop-up waste 1/4" (L).

Ref. 1167

Montura Head: 1700C1/2"

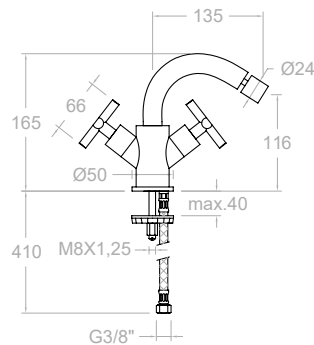

**6203** 252465 266,30 €

Bimando de bidé con caño giratorio.  
Twin lever bidet mixer with swivel spout.



**6203VA1167** 252492 290,30 €

Bimando de bidé con caño giratorio y con válvula automática de latón 1/4".  
Twin lever bidet mixer with swivel spout and automatic brass pop-up waste 1/4".

Ref. 1167

Montura Head: 1700C1/2"

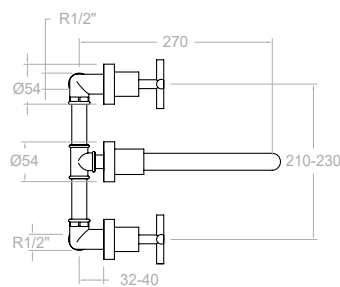

**6220** 252600 390,10 €

Bimando de lavabo empotrado mural.  
Concealed washbasin twin handle chromed.



Montura Head: 1700C1/2"



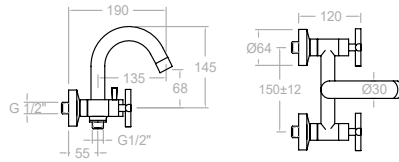

MO



**6205S**  
252510

337,80 €



**Bimando de baño-ducha.**  
Twin lever bath-shower mixer.

**6205MO**  
256929

443,70 €

**Monomando de baño - ducha con equipo de ducha metálico.**  
Bath and shower mixer with shower set.

6205 S + 3749 MO

Montura Head: 1700C1/2"

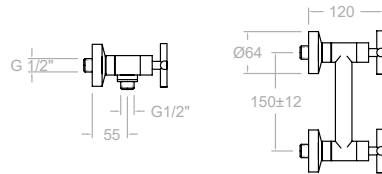

MO



**6208S**  
252573

240,10 €



**Bimando de ducha.**  
Twin lever shower mixer.

**6205MO**  
256929

443,70 €

**Monomando de baño - ducha con equipo de ducha metálico.**  
Bath and shower mixer with shower set.

6205 S + 3749 MO

Montura Head: 1700C1/2"

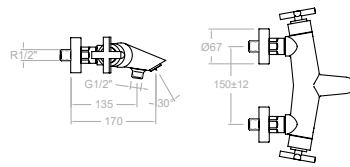

MO



**6239S**  
252699

465,10 €



**Termostático de baño - ducha con inversor integrado, sin equipo de ducha.**  
Thermostatic bath-shower mixer with integrated diverter without shower set.

**6239MO**  
256956

570,90 €

**Termostático de baño - ducha con inversor integrado, con equipo de ducha.**  
Thermostatic bath-shower mixer with integrated diverter with shower set.

6239S+3749MO (3713 M + 3726 M + 2471C)

Cartucho : Cartridge: 1700T + 4000

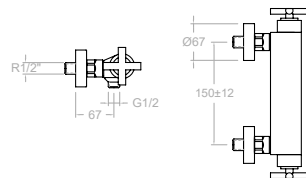

MO



**623402S**  
261899

372,00 €



**Termostático de ducha sin equipo de ducha.**  
Thermostatic shower mixer without shower set.

**623402MO**  
261900

477,90 €

**Termostático de ducha, con equipo de ducha.**  
Thermostatic shower mixer with shower set.

6205 S + 3749 MO

Cartucho : Cartridge: 1701 T + 1700C1/2

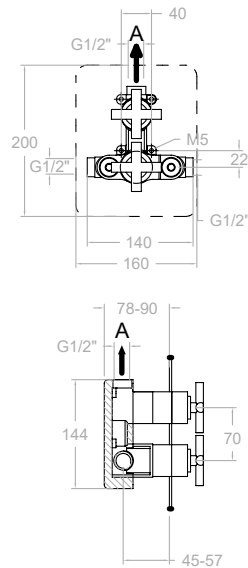

**622411S**  
62D302530

228,50 €

Termostático de ducha empotrado 1 vía con placa metálica.  
Thermostatic concealed shower 1 way with chrome metallic plate.



XX2411S	1bar	3bar	5bar
A l/min	17	26	31

Kit de ampliación - Extension set: KAETI04

Cartucho Cartridge: 1703T + 1700C3/4"

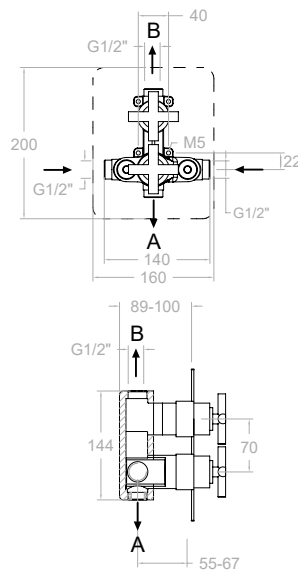

**628712S**  
62D302539

306,80 €

Termostático de baño-ducha empotrado metálico 2 vías con placa metálica.  
Thermostatic concealed shower 2 ways with chrome and slim metallic plate.



XX8712	1bar	3bar	5bar
A l/min	14	24	30
B l/min	13	22	29

Kit de ampliación - Extension set: KAETI03

Cartucho Cartridge: 1703T + 4000

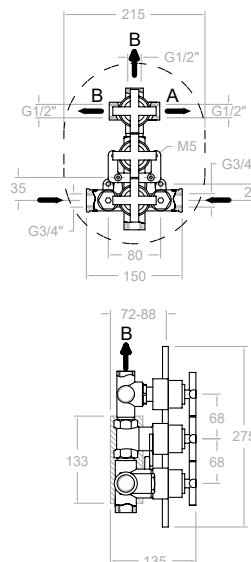

**6227S**  
259908

835,80 €

Termostático de baño-ducha empotrado metálico 3 vías con placa metálica.  
Thermostatic concealed shower 3 ways with chrome and slim metallic plate.



ETDI	CARTUCHO GRAN CAUDAL 1700 TE		
	1 Bar	3 Bar	5 Bar
A (Baño)	13,5	23,3	30,2
B (Baño)	9,3	15,5	19,2

Kit de ampliación - Extension set: KAETDI

Cartucho Cartridge: 1700TE + 1700C3/4" + 1000I



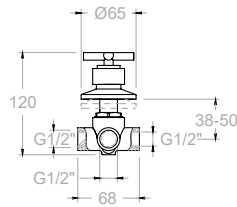

**6237** 188,40 €  
252735

Inversor de 3 vías.  
3 way diverter.  
Cartucho Cartridge: 1000 l

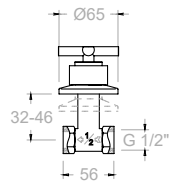

**62071/2X1** 100,10 €  
252744

Llave de paso de 1/2\".  
1/2" angle valve.  
Montura Head: 5000

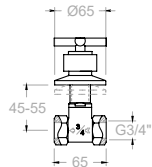

**6237** 188,40 €  
252735

Llave de paso de 3/4\".  
3/4" angle valve.  
Montura Head: 6000

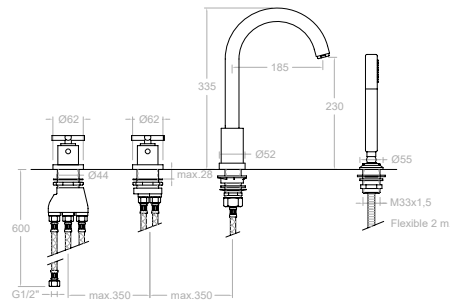

**623303TM** 937,10 €  
62C301674

Termostático de baño-ducha de repisa bimando con equipo de ducha metálica.  
Deck mounted thermostatic bathtub set with shower set.



Cartucho Cartridge: 1700TE + 4000

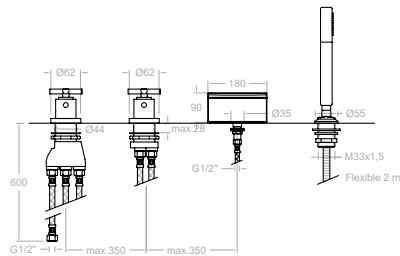

**623304TM** 1.432,10 €  
62C302910

Termostático de baño-ducha de repisa bimando con equipo de ducha metálico y caño en cascada.  
Thermostatic deck-mounted bath shower mixer with metallic shower set and cascade spout.



Cartucho Cartridge: 1700 TE + 4000





**1878RP240**

315,00 €

261504

Titanium, Columna de ducha fija monomando cromada rociador Ø 240 mm.

Titanium, Single lever shower column, fix bar, chrome ABS headshower Ø 240 mm.

Cartucho Cartridge: 35100-3

**1838S**

55,90 €

261503

Titanium, monomando de ducha con salida superior cromado.

Titanium, single lever shower mixer inverted without shower kit.

**BX1878RP240**

1527,90 €

261623

BOX PALET, 5 und. -3% dto. incluido.

BOX PALET, 5 units -3% including discount.



**1874RP240**

378,40 €

261621

Titanium, Columna de ducha fija monomando cromada rociador Ø 240 mm.

Titanium, Single lever shower column, fix bar, chrome ABS headshower Ø 240 mm.

Cartucho Cartridge: 35100-3

**1838S**

55,90 €

261503

Titanium, monomando de ducha con salida superior cromado.

Titanium, single lever shower mixer inverted without shower kit.

**BX1874RP240**

1834,90 €

261622

BOX PALET, 5 und. -3% dto. incluido.

BOX PALET, 5 units -3% including discount.



**944801RP300**

472,40 €

94D303021

941202S+ T100D + RP300 + 2876BT + 2478C

**944801RP300NM**

708,40 €

94D303396

941202SNM+T100DNM+RP300NM +2876BTNM+2475CNM

Conjunto termostático gran ducha con columna fija,  
 accesorios ABS.

Thermostatic shower column fixed height, ABS accesories.

Cartucho Cartridge: 35100 (6689-2)

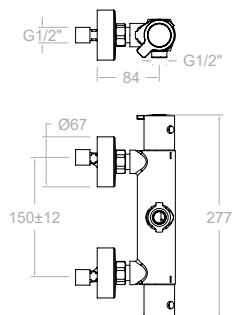
**941202S**

221,10 €

94D302999

**941202SNM**

331,60 €

94D303395

Grifería termostática.

Thermostatic shower.

**BX944801RP300**

2.290,60 €

94G303023

**BX944801RP300NM**

3.436,20 €

94G303398

BOX PALET, 5 unidades -3% Descuento especial incorporado.  
 BOX PALET, 5 units - 3% Special discount in the price.



RM250



3713M



2471C

**944802RM250**

627,50 €

94D303753

941202S+T100D+RM250+3713M+2471C

Conjunto termostático gran ducha con columna fija, accesorios METÁLICOS.

Thermostatic shower column fixed height, METALL accesories.



**BX944802RM250**

3.043,20 €

94G303872

BOX PALET, 5 unidades -3% Descuento especial incorporado.

BOX PALET, 5 units - 3% Special discount in the price.



RK250



4713MK



2471C

**944802RK250**

646,30 €

94D303752

941202S+T100D+RK250+4713MK+2471C

Conjunto termostático gran ducha con columna fija, accesorios METÁLICOS.

Thermostatic shower column fixed height, METALL accesories.



**BX944802RK250**

3.134,30 €

94G303871

BOX PALET, 5 unidades -3% Descuento especial incorporado.

BOX PALET, 5 units - 3% Special discount in the price.



RPK225



3713P



2471C

**944802RPK225**

500,50 €

94D303754

941202S+T100D+RPK225+4713P+2471C

Conjunto termostático gran ducha con columna fija, accesorios ABS.

Thermostatic shower column fixed height, ABS accesories.



**BX944802RPK225**

2.427,50 €

94G303873

BOX PALET, 5 unidades -3% Descuento especial incorporado.

BOX PALET, 5 units - 3% Special discount in the price.



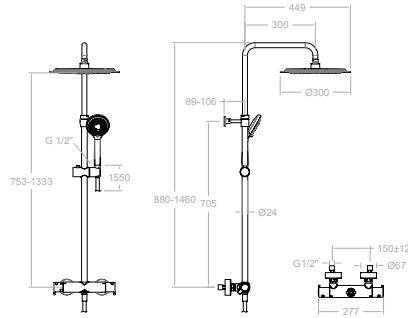

**945401RP300** 575,40 €  
 94D303022  
 941202S + DN130D + RP300 + 2876BT + 2478C

**945401RP300NM** 863,00 €  
 94D303397  
 941202SNM+DN130DNM+RP300NM +2876BTNM+2475CNM

Conjunto termostático gran ducha con columna telescópica , accesorios ABS.  
 Thermostatic telescopic shower column, ABS accesories.

Cartucho Cartridge: 35100 (6689-2)

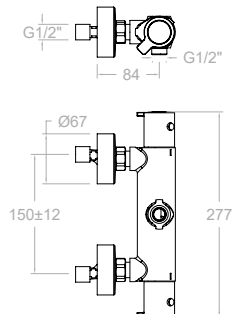

**941202S** 221,10 €  
 94D302999

**941202SNM** 331,60 €  
 94D303395

Grifería termostática.  
 Thermostatic shower.



**BX945401RP300** 2.790,10 €  
 94G303024

**BX945401RP300NM** 4.185,50 €  
 94G303399

BOX PALET, 5 unidades -3% Descuento especial incorporado.  
 BOX PALET, 5 units - 3% Special discount in the price.

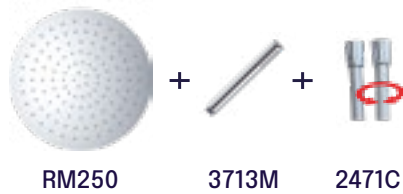

RM250

3713M

2471C



**945402RM250**

713,60 €

94D303760

941202S+DN130D+RM300+3713M+2471C

Conjunto termostático gran ducha con columna telescópica accesorios metálicos.

Thermostatic telescopic shower column with metallic accessories.

**BX945402RM250**

3.460,90 €

94G303879

BOX PALET, 5 unidades -3% Descuento especial incorporado.  
BOX PALET, 5 units - 3% Special discount in the price.



RK250

4713MK

2471C



**945402RK250**

734,10 €

94D303759

941202S+DN130D+RM250+3713M+2471C

Conjunto termostático gran ducha con columna telescópica, accesorios METÁLICOS.

Thermostatic telescopic shower column with METALL accessories.

**BX945402RK250**

3.560,60 €

94G303878

BOX PALET, 5 unidades -3% Descuento especial incorporado.  
BOX PALET, 5 units - 3% Special discount in the price.

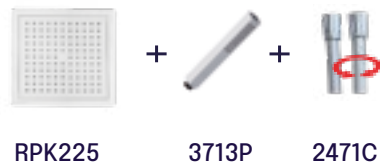

RPK225

3713P

2471C



**945402RPK225**

588,40 €

94D303762

941202S+DN130D+RK250+4713MK+2471C

Conjunto termostático gran ducha con columna telescópica, accesorios METÁLICOS.

Thermostatic telescopic shower column with METALL accessories.

**BX945402RPK225**

2.853,80 €

94G303881

BOX PALET, 5 unidades -3% Descuento especial incorporado.  
BOX PALET, 5 units - 3% Special discount in the price.







RM300



3713M



2471C



**945402RM300**

734,70 €

94D303761

941202S+DN130D+RM300+3713M+2471C

Conjunto termostático gran ducha con columna telescópica accesorios metálicos.

Thermostatic telescopic shower column with metallic accessories.

**BX945402RM300**

3.563,20 €

94G303880

BOX PALET, 5 unidades - 3% Descuento especial incorporado.  
BOX PALET, 5 units - 3% Special discount in the price.



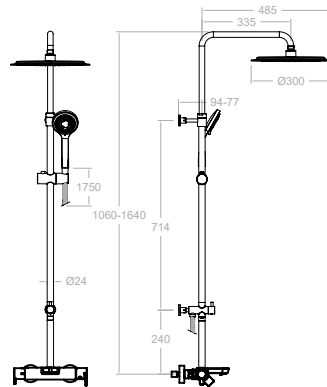
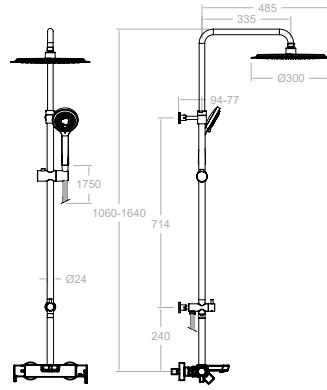

**937802RP240**

427,20 €

94D303831

932802S+T100N+RP240+2876BT+1128C

Conjunto monomando de gran ducha e inversor integrado, con columna fija, accesorios ABS.

Single lever fixed height shower mixer with integrated diverter, ABS accessories.

Cartucho Cartridge: 35100 (6689-2)+ 4004

**BX937802RP240**

2.072,50 €

94G303832

BOX PALET, 5 unidades - 3% Descuento especial incorporado.

BOX PALET, 5 units - 3% Special discount in the price.

**937802RP240NM**

641,10 €

94D303827

932802SNM+T100DNM+RP240NM+2876BTNM+2475CNM

Conjunto monomando de gran ducha e inversor integrado, con columna fija, accesorios ABS.

Single lever fixed height shower mixer with integrated diverter, ABS accessories.

Cartucho Cartridge: 35100 (6689-2)+ 4004

**BX937802RP240NM**

3.108,60 €

94G303828

BOX PALET, 5 unidades - 3% Descuento especial incorporado.

BOX PALET, 5 units - 3% Special discount in the price.

**932802S**

187,70 €

94D303651

**932802SNM**

328,60 €

94D303652

Griferia monomando de gran ducha e inversor integrado.

Single lever with integrated diverter.

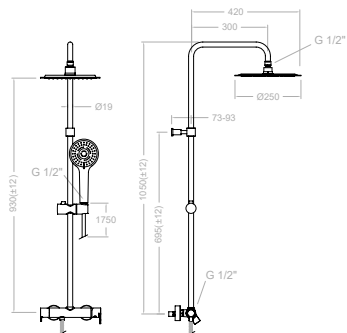

**937802RM250**

556,30 €

94D303899

932802S+T100N+RM250+2876BT+2471C

Conjunto monomando de gran ducha e inversor integrado, con columna fija.

Single lever fixed height shower mixer with integrated diverter, METAL accessories.

Cartucho Cartridge:35100 (6689-2)+ 4004

**BX937802RM250**

2.698,00 €

94G303909

BOX PALET, 5 unidades -3% Descuento especial incorporado.

BOX PALET, 5 units - 3% Special discount in the price.

**932802S**

187,70 €

94D303651

Grifería monomando de gran ducha e inversor integrado.

Single lever with integrated diverter.



**937402RP240** 470,30 €  
 94D303829  
 932802S+DN130+RP240+2876BT+1128C

Conjunto monomando de gran ducha e inversor integrado, con columna telescópica, ABS accesorios.  
 Single lever adjustable height shower mixer with integrated diverter, ABS accessories.

Cartucho Cartridge: 35100 (6689-2)+ 4004

**BX937402RP240** 2.280,40 €  
 94G303830

BOX PALET, 5 unidades -3% Descuento especial incorporado.  
 BOX PALET, 5 units - 3% Special discount in the price.

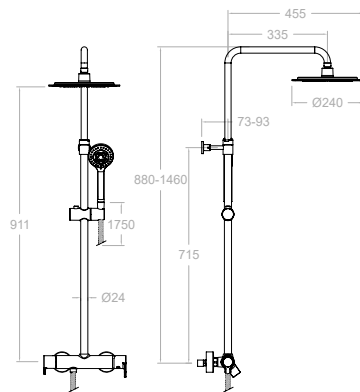

**937402RP240NM** 705,20 €  
 94D303825  
 932802SNM+DN130DNM+RP240NM+2876BTNM+2475CNM

Conjunto monomando de gran ducha e inversor integrado, con columna telescópica, ABS accesorios.  
 Single lever adjustable height shower mixer with integrated diverter, ABS accessories.

Cartucho Cartridge: 35100 (6689-2)+ 4004

**BX937402RP240NM** 3.420,70 €  
 94G303826

BOX PALET, 5 unidades -3% Descuento especial incorporado.  
 BOX PALET, 5 units - 3% Special discount in the price.



**932802S** 187,70 €  
 94D303651

**932802SNM** 328,60 €  
 94D303652

Grifería monomando de gran ducha e inversor integrado.  
 Single lever with integrated diverter.



**937402RM250** 606,50 €  
 94D303894  
 932802S+DN130+RM250+3713M+1128C

**937402RM250NM** 1.061,30 €  
 94D303896  
 932802SNM+DN130DNM+RM250NM+3714NM+2475CNM

Conjunto monomando de gran ducha e inversor integrado, con columna telescópica, accesorios metálicos.  
 Single lever adjustable height shower mixer with integrated diverter, METAL accessories.

Cartucho Cartridge:35100 (6689-2)+ 4004

**BX937402RM250** 2.941,40 €  
 94G303905

**BX937402RM250NM** 5.147,30 €  
 94G303907

BOX PALET, 5 unidades -3% Descuento especial incorporado.  
 BOX PALET, 5 units - 3% Special discount in the price.



**937402RPK225** 821,00€  
 94D303895  
 932802S+DN130+RPK225+4713P+1128C

Conjunto monomando de gran ducha e inversor integrado, con columna telescópica, ABS accesorios.  
 Single lever adjustable height shower mixer with integrated diverter, ABS accessories.

Cartucho Cartridge:35100 (6689-2)+ 4004

**BX937402RPK225** 2.351,30 €  
 94G303906

BOX PALET, 5 unidades -3% Descuento especial incorporado.  
 BOX PALET, 5 units - 3% Special discount in the price.





RK250



4713MK



2471C

**9342RPK225**

430,40 €

259332

9338 S+T100N+IDH1/2+RPK225+4713 P+1128C

**9344RPK225**

471,00 €

259359

9338 S+DN130+IDH1/2+RPK225+4713 P+1128C

Ducha fija.

Shower.

**BX9342RPK225**

2.087,80 €

300338

**BX9344RPK225**

2.284,40 €

260079

BOX PALET, 5 unidades -3% Descuento especial incorporado.

BOX PALET, 5 units - 3% Special discount in the price.

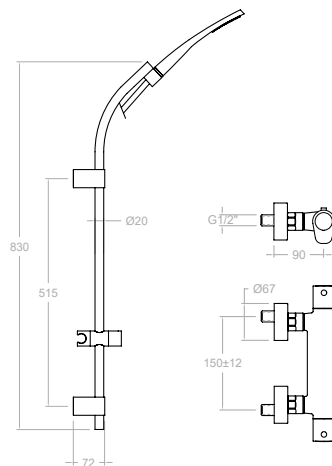
**3695MS**

424,20 €

36D301484

Conjunto termostático de ducha con barra zenit y equipo de ducha.

Thermostatic shower mixer with zenit slide bar and shower set.



Cartucho Cartridge: 1701T + 1700C 1/2"



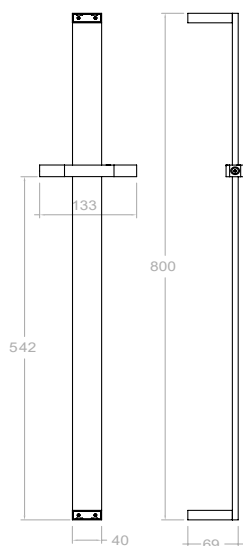

**772001S** 186,70 €  
99Z302190

Barra de ducha cuadrada 80 cm sin accesorios.  
Shower bar without accessories.



**772001MK** 249,70 €  
99H302612  
772001S+4713MK+2471C

Barra de ducha con accesorios MK.  
Shower bar with accessories MK.



**772001K3** 248,00 €  
99H302631  
772001S+4913K3+2471C

Barra de ducha con accesorios K3.  
Shower bar with accessories K3.



**772001K1** 240,40 €  
99H302630  
772001S+4912K1+2471C

Barra de ducha con accesorios K1.  
Shower bar with accessories K1.

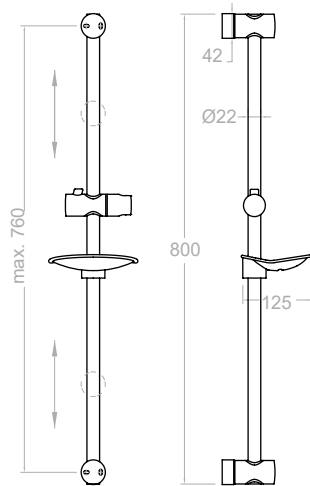

**7780S** 53,60 €  
99Z300925

Barra de ducha sin accesorios, con soportes de fijación pared adaptables.  
Shower bar without accessories with wall fixation adaptable supports.

**7780T1** 89,50 €  
99H300926

Barra de ducha con accesorios.  
Shower bar with accessories.

**7780T3** 95,70 €  
99H300927

Barra de ducha con accesorios.  
Shower bar with accessories.

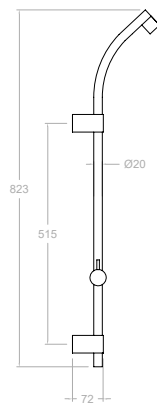

**7740S** 156,90 €  
222630

Barra de ducha de latón, soporte deslizante ABS, sin accesorios.  
Shower bar without accessories.



**7740MS** 203,60 €  
239388

Barra de ducha con accesorios MS.  
Shower bar with MS accessories.

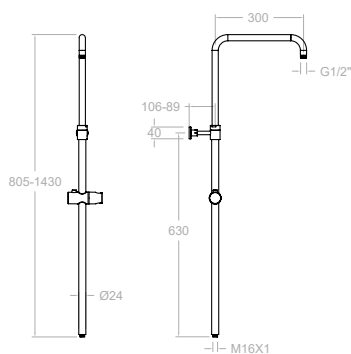

**DN130D** 145,80 €  
AAZ302627

**DN130DNM** 254,50 €  
AAZ303507

**DN130DNC** 254,50 €  
AAZ303888

**DN130DOC** 254,50 €  
AAZ303889

Tubo telescópico sin inversor para conjunto Gran Ducha Ø 24 mm.  
Spout for Greats shower without diverter, adjustable Ø 24 mm.

**DN130** 145,80 €  
218427

Tubo telescópico sin inversor para conjunto Gran Ducha Ø 23 mm.  
Spout for Greats shower without diverter, adjustable Ø 23 mm.

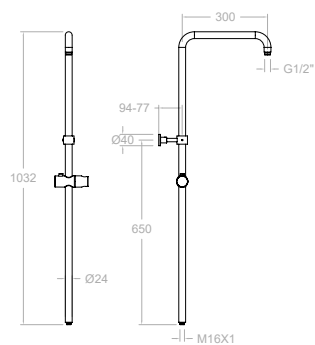

**T100D** 126,20 €  
AAZ301684

**T100DNM** 220,50 €  
AAZ303506

Tubo telescópico sin inversor para conjunto Gran Ducha Ø 24 mm.  
Spout for Greats shower without diverter, adjustable Ø 24 mm.

**T100N** 126,20 €  
242223

Tubo telescópico sin inversor para conjunto Gran Ducha Ø 19 mm.  
Spout for Greats shower without diverter, adjustable Ø 19 mm.

**T200D** 217,60 €  
AAZ303317

Tubo no telescópico sin inversor para T20003 de Ø 19 mm.  
Spout for Greats shower without diverter T20003, no adjustable Ø 19 mm.

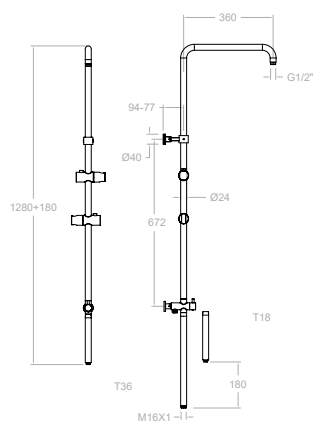

**T100DB**

211,70 €

AAZ301894

SFT24+SD24+T36+IDI 1/2+T18+T100D

Tubo telescópico sin inversor para conjunto Gran Ducha Ø 24 mm.  
Spout for Greats shower without diverter, adjustable Ø 24 mm.

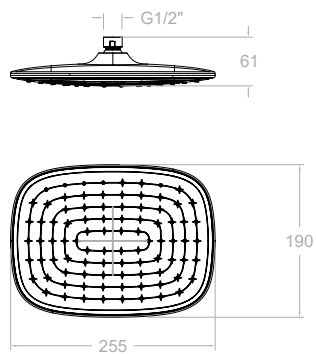

**RPR225**

54,50 €

99Z306273

**RPR225NM**

81,80 €

99Z306275

**RPR225OC**

95,50 €

99Z306278

Rociador rectangular ABS 255x190 mm.  
Showerhead (ABS) 255x190 mm.

bar	Caudal l/min
3	18























# Accesorios

# Accessories





















ramonsoler.



























**MONTURAS Y CARTUCHOS HEAD & CARTRIDGE**

10001 250665	10001 CARTUCHO 3 VIAS PARA 1008		35000 300224	35000 CARTUCHO SALIDA LIBRE ESTANDAR Ø35 (3750)	
43,20 €	10001 3 WAY CARTRIDGE 1008		26,50 €	35000 FREE STANDARD CARTRIDGE Ø35 (3750)	
1700T 184299	1700 T CARTUCHO TERMOSTATICO Ø7.6 Z20 Ø35		35000-2 300225	35000-2 CARTUCHO SALIDA CONDUCCIDA ESTANDAR Ø35 (3760)	
96,10 €	1700T THERMOSTATIC CARTRIDGE Ø35		26,50 €	35000-2 CARTRIDGE DRIVED STANDARD Ø35 (3760)	
1700TE 213576	1700 TE CARTUCHO TERMOSTATICO MAYOR CAUDAL Ø7.6 Z20 Ø35		35000-3 252978	35000-3 CARTUCHO COMPACTO JUNTA SUPERIOR Ø35	
104,60 €	1700 TE THERMOSTATIC CARTRIDGE HIGH FLOW RATE Ø35		26,50 €	35000-3 CARTRIDGE Ø35 SUPERIOR BOARD COMPACT	
1700C1/2 184308	1700C 1/2" MONTURA CERAMICA Ø7.6 Z20		35000-4 AAZ302990	35000-4 CARTUCHO SALIDA CONDUCCIDA ESTANDAR Ø35 PARA COLEX01	
15,30 €	1700C 1/2 CERAMIC HEAD Ø7.6 Z20		26,50 €	35000-4 STANDARD DRIVEN CARTRIDGE Ø35 FOR COLEX01	
1700C3/4 214332	1700C 3/4" MONTURA CERAMICA Ø7.6 Z20		35001-3 AAZ304424	35001-3 CARTUCHO COMPACTO JUNTA SUPERIOR Ø35	
24,90 €	1700C 3/4 CERAMIC HEAD Ø7.6 Z20		26,50 €	35001-3 CARTRIDGE UPPER O-RING Ø35	
1701T 261919	1701 T CARTUCHO TERMOSTATICO BLAUTHERM Ø7.65 Z20 Ø34 NF		35100 252204	35100 (6689-2) CARTUCHO SALIDA LIBRE ESTANDAR Ø35 S2	
100,60 €	1701 T THERMOSTATIC CARTRIDGE BLAUTHERM Ø34 NF		26,50 €	35100 (6689-2) FREE STANDARD CARTRIDGE Ø35 S2	
1703T AAZ302240	1703 T CARTUCHO TERMOSTATICO TERMOTECH Ø7.65 Z20 Ø34		35100-2 AAZ300973	35100-2 CARTUCHO SALIDA CONDUCCIDA Ø35 S2	
96,10 €	1703 T THERMOSTATIC CARTRIDGE TERMOTECH		26,50 €	35100-2 DRIVED CARTRIDGE Ø35 S2	
1703C3/4 AAZ302978	1703C 3/4" MONTURA CERAMICA 1/4V Ø7.6 Z20 PARA XX2411-XX8712		35100-3 AAZ300855	35100-3 CARTUCHO SALIDA CONDUCCIDA JUNTA SUPERIOR Ø35 S2	
24,90 €	1703C 3/4 CERAMIC FRAME 1/4V Ø7.6 Z20 FOR XX2411 & XX8712		26,50 €	35100-3 CARTRIDGE SUPERIOR BOARD Ø35 S2	
25000 261937	25000 CARTUCHO SALIDA LIBRE Ø25 PARA 2602		35200 251781	35200 (6689 C2) CARTUCHO SALIDA LIBRE ESTANDAR Ø35 NF C2	
30,90 €	25000 CARTRIDGE Ø25 FREE OUTPUT FOR 2602		26,50 €	35200 (6689 C2) FREE STANDARD CARTRIDGE Ø35 NF C2	
25000-2 214341	25000-2 (4750) CARTUCHO SALIDA CONDUCCIDA Ø25 PARA KUATRO		35200-2 AAZ304461	35200-2 CARTUCHO SALIDA CONDUCCIDA Ø35 C2	
30,90 €	25000-2 (4750) CARTRIDGE FOR KUATRO		26,50 €	35200-2 SHORT CARTRIDGE Ø35 C2	
25001-2 AAZ306240	25001-2 CARTUCHO SALIDA CONDUCCIDA GRAN CAUDAL Ø25		35200-3 AAZ304467	35200-3 CARTUCHO JUNTA SUPERIOR Ø35 C2	
30,90 €	25001-2 SHORT CARTRIDGE Ø25 BIG FLOW		26,50 €	35200-3 CARTRIDGE UPPER O-RING Ø35 C2	
2600-P 226419	2600-P CARTUCHO PROGRESIVO Ø35 + LLAVE PARA AROLA		35300 261584	35300 (6689 C3) CARTUCHO LIBRE ESTANDAR Ø35 NF C3	
38,90 €	2600-P PROGRESSIVE CARTRIDGE + KEY FOR AROLA		24,80 €	35300 (6689 C3) FREE STANDARD CARTRIDGE Ø35 NF C3	
3380 230442	3380 COBERTOR CARTUCHO 40100 Y 40100-2		35300-3 AAZ300878	35300-3 CARTUCHO JUNTA SUPERIOR Ø35 NF C3	
1,30 €	3380 UNDER LEVEL CARTRIDGE 40100 & 40100-2		29,90 €	35300-3 SUPERIOR BOARD CARTRIDGE Ø35 NF C3	
3390C3/4 230586	3390C 3/4" MONTURA CERAMICA 1/4V Ø7.6 Z20 PARA 3371		35500-3 AAZ306254	35500-3 CARTUCHO JUNTA SUPERIOR Ø35 CH2	
23,40 €	3390C 3/4 CERAMIC HEAD 1/4V Ø7.6 Z20 FOR 3371		26,50 €	35500-3 CARTRIDGE UPPER O-RING Ø35 CH2	
3390F3/4 230613	3390F 3/4" MONTURA CERAMICA 1/4V Ø7.6 Z20 PARA 3371		35600-3 AAZ306255	35600-3 CARTUCHO JUNTA SUPERIOR Ø35 CH3	
23,40 €	3390F 3/4 CERAMIC HEAD 1/4V Ø7.6 Z20 FOR 3371		26,50 €	35600-3 CARTRIDGE UPPER O-RING Ø35 CH3	
			4000 210849	4000 CARTUCHO INVERSOR CON CIERRE PARA TERMOSTICO Ø7.65 Z20 Ø35	
			28,00 €	4000 THERMO DIVERTER CARTRIDGE Ø35	













40000 207789	40000 (6988) CARTUCHO SALIDA LIBRE Ø40 VULCANO		4780 250827	4780 COBERTOR CARTUCHO KUATRO NK	
13,80 €	40000 (6988) CARTRIDGE Ø40 VULCANO		1,20 €	4780 COVER CARTRIDGE KUATRO NK	
40000-2 211236	40000-2 (6988-2) CARTUCHO SALIDA CONDU- CIDA Ø40 PARA 6909-07-11		4970CU AAZ305714	4970 COBRE COBERTOR PARA CARTUCHO Ø25	
13,80 €	40000-2 (6988-2) CARTRIDGE FOR 6909-07-11 VULCANO		4,90 €	4970 COPPER COVER FOR CARTRIDGE Ø25	
40001-2 AAZ301325	40001-2 CARTUCHO SALIDA CONDUCCIDA Ø40 + ANILLO LIMITADOR PARA XX85K		4970 252843	4970 CROMO COBERTOR PARA CARTUCHO Ø25 4X02/4X10 KUATRO NK	
28,00 €	40001-2 DRIVED CARTRIDGE Ø40 + LIMITER RING FOR XX85K		2,90 €	4970 CHROME COVER FOR CARTRIDGE Ø25 4X02/4X10 KUATRO NK	
4005 AAZ302989	4005 CARTUCHO DISTRIBUIDOR SIN CIERRE 45+45 Ø31 PARA COLEX01		4970NM AAZ305664	4970 NEGRO MATE COBERTOR PARA CARTUCHO Ø25	
28,00 €	4005 DIVERTER Ø31 NO CLOUSED 45+45 FOR COLEX01		4,90 €	4970 BLACK MATTE COVER FOR CARTRIDGE Ø25	
40100 217401	40100 (3388) CARTUCHO SALIDA LIBRE Ø40 C2		4970NC AAZ305666	4970 NIQUEL CEPILLADO COBERTOR PARA CARTUCHO Ø25	
16,80 €	40100 (3388) CARTRIDGE FREE Ø40		4,90 €	4970 BRUSHED NICKEL COVER FOR CARTRIDGE Ø25	
40100-2 221442	40100-2 (3388-2) CARTUCHO SALIDA CONDU- CIDA Ø40 S2		4970OC AAZ305665	4970 ORO CEPILLADO COBERTOR PARA CAR- TUCHO Ø25	
16,80 €	40100-2 (3388-2) CARTRIDGE Ø40		4,90 €	4970 BRUSHED GOLD COVER FOR CARTRIDGE Ø25	
40100-3 AAZ304464	40100-3 CARTUCHO JUNTA SUPERIOR Ø40 S2		4980CUC AAZ305720	4980 COBRE CEPILLADO COBERTOR PARA CAR- TUCHO 35000, 35000-2 Y 35000-3	
16,80 €	40100-3 CARTRIDGE Ø40 UPPER O-RING S2		3,70 €	4980 BRUSHED COPPER COVER FOR CARTRIDGE 35000, 35000-2 Y 35000-3	
40101 AAZ300877	40101 CARTUCHO SALIDA LIBRE ESTANDAR EUROPA Ø40 S2		4980 252834	4980 CROMO COBERTOR PARA CARTUCHO 35000, 35000-2 Y 35000-3	
19,20 €	40101 FREE EUROPE CARTRIDGE Ø40 S2		2,10 €	4980 CHROME COVER FOR CARTRIDGE 35000, 35000-2 Y 35000-3	
40200 253653	40200 (3388 K C2) CARTUCHO SALIDA LIBRE ESTANDAR Ø40 NF C2		4980NM AAZ303179	4980 NEGRO MATE COBERTOR PARA CARTUCHO 35000, 35000-2 Y 35000-3	
19,20 €	40200 (3388 K C2) CARTUCHO LIBRE ESTANDAR Ø40 NF C2		4,00 €	4980 BLACK MATTE COVER FOR CARTRIDGE 35000, 35000-2 & 35000-3	
40200-2 253671	40200-2 (3388-2 K C2) CARTUCHO SALIDA CONDUCCIDA ESTANDAR Ø40 NF C2		4980NC AAZ303178	4980 NIQUEL CEPILLADO COBERTOR PARA CARTUCHO 35000, 35000-2 Y 35000-3	
19,20 €	40200-2 (3388-2 K C2) DRIVED STANDARD CAR- TRIDGE Ø40 NF C2		4,00 €	4980 BRUSHED NICKEL COVER FOR CARTRIDGE 35000, 35000-2 Y 35000-3	
40200-3 AAZ304457	40200-3 CARTUCHO JUNTA SUPERIOR Ø40 C2		4980OC AAZ303180	4980 ORO CEPILLADO COBERTOR PARA CARTU- CHO 35000, 35000-2 Y 35000-3	
19,20 €	40200-3 CARTRIDGE UPPER JOINT Ø40 C2		4,00 €	4980 BRUSHED GOLD COVER FOR CARTRIDGE 35000, 35000-2 Y 35000-3	
40300 253644	40300 (3388 K C3) CARTUCHO SALIDA LIBRE ESTANDAR Ø40 C3		5000 800413	5000 1/2" MONTURA CLASICA Ø9 Z18 ECO	
20,60 €	40300 (3388 K C3) FREE STARNDARD CARTRIDGE Ø40 C3		9,40 €	5000 1/2 CLASSIC HEAD Ø9 Z18 ECO	
40300-2 253662	40300-2 (3388-2 K C3) CARTUCHO SALIDA CONDUCCIDA ESTANDAR Ø40 C3		5780 57Z304409	5780 CROMO COBERTOR PARA CARTUCHO 40100-3, 40200-3 Y 40301-3 NEW FLY	
20,60 €	40300-2 (3388-2 K C3) STANDARD DRIVED CARTRIDGE Ø40 C3		5,30 €	5780 CHROMED COVER FOR CARTRIDGE 40100-3, 40200-3 & 40301-3 NEW FLY	
40300-3 AAZ304029	40300-3 CARTUCHO JUNTA SUPERIOR Ø40 C3		5780NM AAZ304486	5780 NEGRO MATE COBERTOR PARA CARTUCHO 40100-3, 40200-3 Y 40301-3 NEW FLY	
26,50 €	40300-3 CARTRIDGE UPPER JOINT Ø40 C3		9,10 €	5780 COVER BLACK MATTE FOR CARTRIDGE 40100-3, 40200-3 Y 40301-3 NEW FLY	
40301-3 AAZ304466	40301-3 CARTUCHO JUNTA SUPERIOR Ø40 S3		6000 128329	6000 3/4" MONTURA CLASICA Ø9 Z18 ORLA	
26,50 €	40301-3 CARTRIDGE UPPER JOINT Ø40 S3		30,90 €	6000 3/4 CLASSIC HEAD Ø9 Z18 ORLA	
4760T 217518	4760 T CARTUCHO TERMOKUATRO Ø7.6 Z20 Ø24 NF		7000 117395	7000 1/2" MONTURA CERAMICA Ø9 Z18	
84,20 €	4760T CARTRIDGE TERMOKUATRO Ø24 NF		18,50 €	7000 1/2 CERAMIC HEAD Ø9 Z18	

7800 197808	7800 1/2" MONTURA CLASICA Ø7.8 Z20 REGINA		TSC3 167172	TSC3 TUERCA APRIETE CARTUCHO 9000N	
18,50 €	7800 1/2 CLASSIC HEAD Ø7.8 Z20 REGINA		2,40 €	TSC3 CARTRIDGE NUT 9000N	
7800C 229146	7800C 1/2" MONTURA CERAMICA Ø7.8 Z20 REGINA		TSC310 AAZ302987	TSC310 TUERCA APRIETE CARTUCHO DISTRIBUIDOR PARA COLEX01	
21,20 €	7800C 1/2 HEAD CERAMIC Ø7.8 Z20 REGINA		24,80 €	TSC310 NUT DIVERTER CARTRIDGE FOR COLEX01	
9000NTSC3 166893	9000N + TSC3 CARTUCHO AQUANOVA FLY		TSC350 253014	TSC350 TUERCA APRIETE CARTUCHO 35000, 35000-2 Y 35000-3	
28,00 €	9000N + TSC3 CARTRIDGE AQUANOVA		2,40 €	TSC350 NUT CARTRIDGE 35000, 35000-2 Y 35000-3	
CDG 175137	CDG CASQUILLO INOX DISCO GOMA		TSC351 250863	TSC351 (TSC9) TUERCA APRIETE CARTUCHO Ø35 4X25/8, XX1502/3 Y XX1801	
0,70 €	CDG STAINSTEEL RING RUBBER GASKET		2,40 €	TSC351 (TSC9) NUT TIGHTER CARTRIDGE Ø35 4X25/8, XX1502/3 & XX1801	
CO01 AAZ302991	CO01 COBERTOR CARTUCHO 35000-4 PARA COLEX01		TSC352 252870	TSC352 TUERCA APRIETE CARTUCHO 4000	
12,40 €	CO01 COVER CARTRIDGE 35000-4 FOR COLEX01		7,90 €	TSC352 NUT TIGHTER CARTRIDGE 4000	
DG 162402	DG DISCO GOMA MONTURA 5000		TSC353 240909	TSC353 (TSC8) TUERCA APRIETE CARTUCHO 6688-6689	
0,70 €	DG RUBBER RING FOR HEAD 5000		2,40 €	TSC353 (TSC8) TUERCA PARA CART. 6688-6689	
MC80 AAZ301322	MC80 CROMO COBERTOR CARTUCHO PARA XX76-XX85		TSC354 261914	TSC354 TUERCA APRIETE CARTUCHO PARA XX1202 + 9328	
18,10 €	MC80 CHROME COVER CARTRIDGE FOR XX76-XX85		2,40 €	TSC354 NUT TIGHTER CARTRIDGE FOR XX1202 + 9328	
MC82NM AAZ305289	MC82 NEGRO MATE COBERTOR CARTUCHO PARA XX7602NM-XX8503NM		TSC355 AAZ300865	TSC355 TUERCA APRIETE CARTUCHO 4000 BAÑO REPISA	
28,90 €	MC82 BLACK MATTE COVER CARTRIDGE FOR XX7602NM-XX8503NM		7,90 €	TSC355 NUT TIGHTER CARTRIDGE 4000 BATH DECK	
MCK80 AAZ301321	MCK80 COBERTOR CARTUCHO PARA XX85K		TSC357 AAZ302988	TSC357 TUERCA APRIETE CARTUCHO MONOMANDO PARA COLEX01	
65,60 €	MCK80 COVER CARTRIDGE FOR XX85K		24,80 €	TSC357 NUT SINGLE LEVER CARTRIDGE FOR COLEX01	
TSC1008 255345	TSC1008 TUERCA CON ALARGO PARA CARTUCHO 3 VIAS		TSC358 AAZ303018	TSC358 TUERCA NIQUELADA CARTUCHO DISTRIBUIDOR Ø35	
47,10 €	TSC1008 NUT WITH ALONG FOR CARTRIDGE 3 WAYS		4,00 €	TSC358 NICKEL PLATED NUT FOR Ø35 DIVERTER CARTRIDGE	
TSC2 160211	TSC2 TUERCA APRIETE CARTUCHO AQUAMANDO		TSC400 230451	TSC400 (TSC6) TUERCA APRIETE CARTUCHO Ø40	
2,40 €	TSC2 AQUAMANDO CARTRIDGE NUT		2,40 €	TSC400 (TSC6) NUT TIGHTENING CARTRIDGE DRAKO	
TSC250 252852	TSC250 TUERCA APRIETE CARTUCHO 25000-2 KUATRO		TSC401 253113	TSC401 TUERCA APRIETE CARTUCHO 40000 Y 40000-2	
7,90 €	TSC250 NUT TIGHTER CARTRIDGE 25000-2 KUATRO		7,90 €	TSC401 NUT TIGHTER CARTRIDGE 40000 Y 40000-2	
TSC251 252348	TSC251 (TSC12) TUERCA APRIETE CARTUCHO Ø25		TSC4760T 300065	TSC4760T TUERCA APRIETE CARTUCHO 4760T	
7,90 €	TSC251 (TSC12) NUT TIGHTER CARTRIDGE Ø25		7,90 €	TSC4760T NUT TIGHTER CARTRIDGE 4760T	
TSC252 261938	TSC252 TUERCA APRIETE CARTUCHO 25000		TSC7 240936	TSC7 TUERCA ALTA APRIETE CARTUCHO PARA XX07 CC	
7,90 €	TSC252 NUT TIGHTER CARTRIDGE 25000		3,80 €	TSC7 HIGH NUT CARTRIDGE FOR XX07 CC	
TSC253 251673	TSC253 TUERCA APRIETE CARTUCHO 4001		TSC8502 AAZ305291	TSC8502 TUERCA APRIETE CARTUCHO PARA XX7602-XX8502	
2,40 €	TSC253 NUT CARTRIDGE 4001		7,20 €	TSC8502 NUT CARTRIDGE FOR XX7602-XX8502	
TSC255 AAZ302608	TSC255 TUERCA APRIETE CARTUCHO LAV. CASCADA URBAN CHIC		1705T AAZ305575	1705 T CARTUCHO TERMOSTATICO Ø765 Z20 Ø34 C3	
2,40 €	TSC255 NUT CARTRIDGE WATERFALL URBAN CHIC		10,30 €		



























35001-2 AAZ305771	35001-2 CARTUCHO SALIDA CONDUCCIDA Ø35 PARA XX7602-XX8503	
26,50 €		
35002-2 AAZ305772	35002-2 CARTUCHO SALIDA CONDUCCIDA Ø35 PARA 4X8502	
26,50 €		
DIMC01 AAZ305815	DIMC01 DISTRIBUIDOR BAÑO-DUCHA PARA XX8503-4X8502	
32,30 €		
TSC256 AAZ306246	TSC256 TUERCA APRIETE LATON CARTUCHO Ø25	
2,40 €		

TSCMC01 AAZ305773	TSCMC01 TUERCA APRIETE CARTUCHO BA-SE-COLUMNNA PARA XX7602	
7,90 €		
TSCMC02 AAZ305774	TSCMC02 TUERCA APRIETE CARTUCHO BA-SE-COLUMNNA PARA 4X7602-4X8502	
7,90 €		
TSCMC03 AAZ305775	TSCMC03 TUERCA APRIETE CARTUCHO BA-SE-COLUMNNA PARA XX8503	
7,90 €		

**CAÑOS SPOUT**

1400 222414	1400 ADAPTADOR 3/4" PARA CAÑO TUBO CA, CB Y CE	
4,80 €	1400 TUBE ADAPTOR 3/4 SPOUT CA, CB & CE	
1430 241269	1430 MANGUITO 3/4" PARA CAÑO CE28, U, L Y CE21	
8,00 €	1430 SLEEVE 3/4 FOR CE28, U, L & CE21	
1433 250764	1433 MANGUITO 3/4" FREGADERO ABATIBLE XX69	
8,70 €	1433 SLEEVE 3/4 FOR XX69	
1450 252933	1450 MANGUITO CAÑO Ø24	
6,90 €	1450 SLEEVE SPOUTS Ø24	
1470 AAZ304527	1470 MANGUITO 3/4" PARA CAÑO CC07/11 Y CCB14	
8,00 €	1470 SLEEVE 3/4 FOR CC07/11 & CCB14	
166 208401	166 CROMO CAÑO 1/2" BAÑERA	
101,00 €	166 CHROME BATH SPOUT 1/2	
C2401 300035	C2401 CROMO CAÑO CORTO FREGADERO	
42,50 €	C2401 CHROME SPOUT SHORT SINK	
C2402 300036	C2402 CROMO CAÑO LARGO FREGADERO	
43,90 €	C2402 CHROMED SPOUT LONG SINK	
C2403 300037	C2403 CROMO CAÑO LAVABO GIRATORIO	
38,40 €	C2403 CHROMED SPOUT WASH BASIN SWIVEL	
C2404CUC AAZ305721	C2404 COBRE CEPILLADO CAÑO ALTO FREG. PARA 332902CUC	
69,80 €	C2404 BRUSHED COPPER SPOUT HIGH SINK FOR 332902CUC	
C2404 AAZ301677	C2404 CROMO CAÑO ALTO FREGADERO PARA 332902	
40,00 €	C2404 CHROME SPOUT HIGH SINK FOR 332902	
C2601 261933	C2601 CROMO CAÑO BATERIA LAVABO AROLA	
112,90 €	C2601 CHROME SPOUT WASH BASIN AROLA	

C7602K AAZ305757	C7602K CROMO CAÑO PARA 4X7602	
302,10 €	C7602K CHROME SPOUT FOR 4X7602	
C7602KNM AAZ305758	C7602K NEGRO MATE CAÑO PARA 4X7602NM	
528,70 €	C7602K BLACK MATTE SPOUT FOR 4X7602NM	
C7602KNC AAZ305760	C7602K NIQUEL CEPILLADO CAÑO PARA 4X7602NC	
528,70 €	C7602K BRUSHED NICKEL SPOUT FOR 4X7602NC	
C7602KOC AAZ305759	C7602K ORO CEPILLADO CAÑO PARA 4X7602OC	
528,70 €	C7602K BRUSHED GOLD SPOUT FOR 4X7602OC	
C7602R AAZ305754	C7602R CROMO CAÑO PARA XX7602	
266,90 €	C7602R CHROME SPOUT FOR XX7602	
C7602RNM AAZ305753	C7602R NEGRO MATE CAÑO PARA XX7602NM	
467,20 €	C7602R BLACK MATTE SPOUT FOR XX7602NM	
C7602RNC AAZ305756	C7602R NIQUEL CEPILLADO CAÑO PARA XX7602NC	
467,20 €	C7602R BRUSHED NICKEL SPOUT FOR XX7602NC	
C7602ROC AAZ305755	C7602R ORO CEPILLADO CAÑO PARA XX7602OC	
467,20 €	C7602R BRUSHED GOLD SPOUT FOR XX7602OC	
C85 AAZ301319	C85 CROMO CAÑO + AIREADOR + JUNTA PARA XX85	
302,10 €	C85 CHROME SPOUT + AERATOR + O-RING FOR XX85	
C8502NM AAZ305293	C8502 NEGRO MATE CAÑO PARA XX8503NM	
482,00 €	C8502R BLACK MATTE SPOUT FOR XX8503NM	
CA21 216771	CA21 CROMO CAÑO ALTO DE 21CM	
21,70 €	CA21 CHROME HIGH SPOUT 21 CM	
CAI30 216753	CAI30 CROMO CAÑO ALTO INCLINADO 30CM	
26,50 €	CAI30 HIGH SPOUT 30CM	



























C2610 261567	C2610 CROMO CAÑO BATERIA LAVABO ALTO AROLA		CB21 226284	CB21 CROMO CAÑO BAJO 21CM	
165,50 €	C2610 CHROMED SPOUT WASH BASIN HIGH AROLA		21,70 €	CB21 CHROME LOW SPOUT 21CM	
C6205 261952	C6205 CROMO CAÑO CONFORMADO BAÑO RS-CROSS		CB30 216762	CB30 CROMO CAÑO BAJO 30CM	
114,40 €	C6205 SPOUT CONFORMED FOR 6205 RS-CROSS		26,50 €	CB30 CHROME LOW SPOUT 30CM	
C623302 622301711	C623302 CAÑO CON CUERPO PARA XX3302		CBA AAZ305389	CBA CROMO CAÑO SIMPLE BAÑERA PARA 16602 ALEXIA	
206,30 €	C623302 SPOUT WITH BODY FOR 623302		77,70 €	CBA CHROME SIMPLE BATH SPOUT FOR 16602 ALEXIA	
C76 AAZ301320	C76 CROMO CAÑO + AIREADOR + JUNTA PARA XX76		CBANM AAZ305390	CBA NEGRO MATE CAÑO SIMPLE PARA 16602 ALEXIA	
189,50 €	C76 SPOUT + AERATOR + O-RING FOR XX76		136,00 €	CBA BLACK MATTE SIMPLE BATH SPOUT FOR 16602 ALEXIA	
CBANC AAZ305392	CBA NIQUEL CEPILLADO CAÑO SIMPLE PARA 16602 ALEXIA		CLEA 362300936	CLEA CROMO CAÑO PARA EMPOTRADOS ALEXIA	
136,00 €	CBA BRUSHED NICKEL SIMPLE BATH SPOUT FOR 16602 ALEXIA		77,70 €	CLEA CHROME SPOUT FOR CONCEALED ALEXIA	
CBAOC AAZ305391	CBA ORO CEPILLADO CAÑO SIMPLE PARA 16602 ALEXIA		CLEANM AAZ303001	CLEA NEGRO MATE CAÑO PARA EMPOTRADOS ALEXIA	
136,00 €	CBA BRUSHED GOLD SIMPLE BATH SPOUT FOR 16602 ALEXIA		137,20 €	CLEA BLACK MATTE SPOUT FOR CONCEALED ALEXIA	
CBET16 AAZ303694	CBET16 CAÑO CROMO BAÑO EMPOTRADO TUBO 16CM		CLEANC AAZ303000	CLEA NIQUEL CEPILLADO CAÑO PARA EMPOTRADOS ALEXIA	
136,30 €	CBET16 CAÑO CROMO BAÑO EMPOTRADO TUBO 16 CM		137,20 €	CLEA BRUSHED NICKEL SPOUT FOR CONCEALED ALEXIA	
CC06-2 252942	CC06-2 CAÑO CONFORMADO FREGADERO		CLEAOC AAZ303002	CLEA ORO CAÑO PARA EMPOTRADOS ALEXIA	
38,60 €	CC06-2 SPOUT CONFORMED SINK		136,00 €	CLEA BRUSHED GOLD SPOUT FOR CONCEALED ALEXIA	
CC07/11 230505	CC07/11 CAÑO CONFORMADO FREGADERO BAJO Ø28 213mm		CLEK AAA300939	CLEK CAÑO CROMO LAVABO EMPOTRADOS KUATRO	
38,60 €	CC07/11 CAST SPOUT SINK MIXER		77,70 €	CLEK CHROME SPOUT WASHBASIN CONCEALED KUATRO	
CC10 217905	CC10 CAÑO CONFORMADO CON MANGUITO LAVABO		CLET AAA300938	CLET CROMO CAÑO LAVABO EMPOTRADO TUBO 19CM	
38,60 €	CC10 CAST SPOUT BASIN MIXER		48,20 €	CLET CHROME SPOUT WASH BASIN CONCEALED TUBE 19 CM	
CC17 253104	CC17 CAÑO CONFORMADO CON MANGUITO FREGADERO MURAL		CLETNM AAZ303004	CLET NEGRO MATE CAÑO LAVABO EMPOTRADO TUBO 19CM	
38,60 €	CC17 SPOUT CONFORMED SINK MURAL		87,30 €	CLET BLACK MATTE SPOUT WASHBASIN CONCEALED TUBE 19 CM	
CCB14 AAZ302374	CCB14 CAÑO CONFORMADO 140MM PARA FREGADERO BAJO XX07		CLETNC AAZ303003	CLET NIQUEL CEPILLADO CAÑO LAVABO EMPO. TUBO 19CM	
33,20 €	CCB14 CAÑO CONFORMADO 140MM PARA FREGADERO XX07		87,30 €	CLET BRUSKED NICKEL SPOUT WASHBASIN CONCEALED TUBE 19 CM	
CDOA3369 254607	CDOA3369 CODO PARA ABATIBLE		CLETOC AAZ303005	CLET ORO CEPILLADO CAÑO LAVABO EMPO. TUBO 19CM	
55,00 €	CDOA3369 ELBOW		87,30 €	CLET BRUSKED GOLD SPOUT WASHBASIN CONCEALED TUBE 19 CM	
CE08Y 251799	CE08Y CROMO CAÑO TUBO CON MANGUITO FREGADERO		CLET24 AAZ301304	CLET24 CROMO CAÑO LAVABO EMPOTRADO TUBO 24CM	
30,90 €	CE08Y CHROMED SPOUT TUBE SINK		58,40 €	CLET24 CHROME SPOUT WASHBASIN CONCEALED TUBE 24 CM	
CE10 216744	CE10 CROMO CAÑO TUBO LAVABO		CLET24NM AAZ302770	CLET24 NEGRO MATE CAÑO LAVABO EMPO. TUBO 24CM	
23,50 €	CE10 CHROME TUBE SPOUT WASH BASIN		103,20 €	CLET24 BLACK MATTE SPOUT CONCEALED WASHBASIN TUBE 24 CM	
CE11 228858	CE11 CROMO CAÑO TUBO BIDE		CLET24NC AAZ303006	CLET24 NIQUEL CEPILLADO CAÑO LAVABO EMPO. TUBO 24CM	
21,60 €	CE11 CHROME TUBE SPOUT BIDET		103,20 €	CLET24 BRUSHED NICKEL WASHBASIN WALL-MOUNTED SPOUT TUBE 24	



















CE28B 239235	CE28B CROMO CAÑO CON MANGUITO BAÑO REPISA Ø28	
72,80 €	CE28B CROMO BATH SPOUT Ø28	
CEA 250755	CEA CAÑO CONFORMADO ABATIBLE XX69	
38,60 €	CEA SPOUT CONFORMED AVATIBLE XX69	
CEX2800H 261906	CEX2800H CAÑO TUBO PARA EXTRAIBLE XX19H Y XX1902H	
57,70 €	CEX2800H SPOUT OF TUBE FOR WITH EXTENSIBLE HOSE XX19H & XX1902H	
CEX2802V AAZ301679	CEX2802V CAÑO DE TUBO PARA EXTRAIBLE XX7902V	
96,10 €	CEX2802V SPOUT OF TUBE FOR WITH EXTENSIBLE HOSE XX7902V	
CLEUOC AAZ305158	CLEU ORO CEPILLADO CAÑO PARA EMPOTRADOS URBAN CHIC	
141,50 €	CLEU BRUSHED GOLD SPOUT FOR CONCEALED URBAN CHIC	
MFCB AAZ305164	MFCB MANGUITO FIJACION CAÑO PARA BAÑERA	
4,90 €	MFCB SLEEVE FIXING SPOUT FOR BATH	
BRECLET24 AAZ306746	BRECLET24 CROMO CAÑO LAVABO EMPOTRADO TUBO 24CM 5L	
61,30 €		
BRECLET24NM AAZ306741	BRECLET24NM NEGRO MATE CAÑO LAVABO EMPO. TUBO 24CM 5L	
108,40 €		
BREHCLET24 AAZ307340	BREHCLET24 CROMO CAÑO LAVABO EMPOTRADO TUBO 24CM 3.5L	
108,40 €		
BREHCLET24NM AAZ307338	BREHCLET24NM NEGRO MATE CAÑO LAVABO EMPO. TUBO 24CM 3.5L	
108,40 €		
C8502KOC AAZ305768	C8502KOC ORO CEPILLADO CAÑO PARA 4X8502OC	
324,50 €		
C8503R AAZ305762	C8503R CROMO CAÑO PARA XX8503	
185,40 €		
C8503RNC AAZ305765	C8503RNC NIQUEL CEPILLADO CAÑO PARA XX8503NC	
324,50 €		
C8503RNM AAZ305763	C8503RNM NEGRO MATE CAÑO PARA XX8503NM	
278,10 €		

CLET24OC AAZ303007	CLET24 ORO CEPILLADO CAÑO LAVABO EMPO. TUBO 24CM	
103,20 €	CLET24 BRUSHED GOLD WASHBASIN WALL-MOUNTED SPOUT TUBE 24	
CLEU AAZ302433	CLEU CROMO CAÑO PARA EMPOTRADOS URBAN CHIC	
80,00 €	CLEU CHROME SPOUT FOR CONCEALED URBAN CHIC	
CLEUNM AAZ304850	CLEU NEGRO MATE CAÑO PARA EMPOTRADOS URBAN CHIC	
141,50 €	CLEU BLACK MATTE SPOUT FOR CONCEALED URBAN CHIC	
CLEUNC AAZ305157	CLEU NIQUEL CEPILLADO CAÑO PARA EMPOTRADOS URBAN CHIC	
141,50 €	CLEU BRUSHED NICKEL SPOUT FOR CONCEALED URBAN CHIC	
RDCF AAA301874	RDCF RACOR LAVABO EMPOTRADO CAÑO FUNDIDO PARA XX20CF	
4,90 €	RDCF SET RACOR CONCEALED WASHBASIN FOR XX20CF	
RDCT AAA301873	RDCT RACOR LAVABO EMPOTRADO CAÑO TUBO PARA XX20CT	
7,90 €	RDCT SET CONCEALED WASHBASIN FOR XX20CT	
C2401NM AAZ306749	C2401NM NEGRO MATE CAÑO CORTO FREGADERO	
63,90 €		
C8502K AAZ305766	C8502K CROMO CAÑO PARA 4X8502	
185,40 €		
C8502KNC AAZ305769	C8502KNC NIQUEL CEPILLADO CAÑO PARA 4X8502NC	
324,50 €		
C8502KNM AAZ305767	C8502KNM NEGRO MATE CAÑO PARA 4X8502NM	
278,10 €		
C8503ROC AAZ305764	C8503ROC ORO CEPILLADO CAÑO PARA XX8503OC	
324,50 €		
CLET24CUC AAZ307683	CLET24CUC COBRE CEPILLADO CAÑO LAVABO EMPO. TUBO 24CM	
103,20 €		
CLETCUC AAZ307682	CLETCUC COBRE CEPILLADO CAÑO LAVABO EMPO. TUBO 19CM	
87,30 €		

































































**EXCENTRICAS, FLORONES Y ASIENTOS SEATS ANS PLATES**



















1170 154013	1170 CROMO FLORON LLAVES DE PASO ECO		1323NM AAZ303192	1323 NEGRO MATE FLORON CILINDRICO	
11,60 €	1170 CHROME UNDER LEVEL STOCPCOCK VALVE ECO		11,00 €	1323 BLACK MATTE COVER PLATE CYLINDRICAL	
1171 300218	1171 CROMO FLORON INVERSOR 3 VIAS		1323NC AAZ303191	1323 NIQUEL CEPILLADO FLORON CILINDRICO	
14,40 €	1171 CHROME ESCUTCHEON INVERTER 3 WAYS		11,00 €	1323 BRUSHED NICKEL COVER PLATE CYLINDRICAL	
1171NM AAZ305445	1171 NEGRO MATE FLORON INVERSOR 3 VIAS		1323OC AAZ303193	1323 ORO CEPILLADO FLORON CILINDRICO	
25,00 €	1171 BLACK MATTE ESCUTCHEON INVERTER 3 WAYS		11,00 €	1323 BRUSHED GOLD COVER PLATE CYLINDRICAL	
1171NC AAZ305447	1171 NIQUEL CEPILLADO FLORON INVERSOR 3 VIAS		1324 182094	1324 CROMO FLORON + EXCENTRICA STANDARD	
25,00 €	1171 BRUSHED NICKEL ESCUTCHEON INVERTER 3 WAYS		11,00 €	1324 CHROME COVER PLATE + ECCENTRIC STANDARD	
1171OC AAZ305446	1171 ORO CEPILLADO FLORON INVERSOR 3 VIAS		1324NF AAZ302185	1324NF CROMO FLORON CONICO +EXCENTRICA+SILENCIADOR+FILTRO REJILLA	
25,00 €	1171 BRUSHED GOLD ESCUTCHEON INVERTER 3 WAYS		12,80 €	1324NF CROMO FLORON+EXCENTRICA+SILENCIADOR+FILTRO	
1172 AAZ305441	1172 CROMO FLORON LLAVES DE PASO 1/2" Y 3/4"		1325 167127	1325 CROMO PLACA FLORON CONICO	
25,00 €	1172 CHROME UNDER LEVEL STOCPCOCK VALVE 1/2 & 3/4		4,80 €	1325 CHROME COVER PLATE CONICAL	
1172NM AAZ305442	1172 NEGRO MATE FLORON LLAVES DE PASO 1/2" Y 3/4"		1326 210660	1326 CROMO FLORON CILINDRICO + EXCENTRICA STD	
43,90 €	1172 BLACK MATTE UNDER LEVEL STOCPCOCK VALVE 1/2 & 3/4		13,70 €	1326 CYLINDRICAL CHROME COVER PLATE + ECCENTRIC STD	
1172NC AAZ305444	1172 NIQUEL CEPILLADO FLORON LLAVES DE PASO 1/2" Y 3/4"		1326NM AAZ303195	1326 NEGRO MATE FLORON CILINDRICO + EXCENTRICA STD	
43,90 €	1172 BRUSHED NICKEL UNDER LEVEL STOCPCOCK VALVE 1/2 & 3/4		25,00 €	1326 BLACK MATTE CYLINDRICAL COVER PLATE + ECCENTRIC STD	
1172OC AAZ305443	1172 ORO CEPILLADO FLORON LLAVES DE PASO 1/2" Y 3/4"		1326NC AAZ303194	1326 NIQUEL CEPILLADO FLORON CILINDRICO + EXCENTRICA STD	
43,90 €	1172 BRUSHED GOLD UNDER LEVEL STOCPCOCK VALVE 1/2 & 3/4		25,00 €	1326 BRUSHED NICKEL CYLINDRICAL COVER PLATE + ECCENTRIC STD	
1320 154111	1320 CROMO FLORON + EXCENTRICA CON SILENCIADOR		1326OC AAZ303196	1326 ORO CEPILLADO FLORON CILINDRICO + EXCENTRICA STD	
11,00 €	1320 CROME COVER PLATE + ECCENTRIC WITH SILENCER		25,00 €	1326 BRUSHED GOLD CYLINDRICAL COVER PLATE + ECCENTRIC STD	
1321 216393	1321 RACOR RECTO DE 1/2" A 3/4" CON FLORON		1326NF AAZ302187	1326NF CROMO FLORON CILINDRICO+EXCENTRICA+SILENCIADOR+FILTRO REJILLA	
19,60 €	1321 STRAIGHT CONNEC 1/2-3/4 WITH UNDER LEVEL		13,70 €	1326NF WALL CYLINDRICAL COVER + ECCENTRIC WITH SILENCER	
1322 221982	1322 CROMO PLACA FLORON CUADRADO		1326NFM AAZ304273	1326NF NEGRO MATE FLORON CILINDRICO+EXCENTRICA+SILENCIADOR+FILTRO REJILLA	
11,00 €	1322 CHROME COVER PLATE SQUARE		23,90 €	1326NF BLACK MATTE WALL CYLINDRICAL COVER + ECCENTRIC WITH SILENCER	
1323 220749	1323 CROMO FLORON CILINDRICO		1326NFNC AAZ305668	1326NF NIQUEL CEPILLADO FLORON CILINDRICO+EXCENTRICA+SILENCIADOR+FILTRO REJILLA	
6,20 €	1323 CHROME COVER PLATE CYLINDRICAL		23,90 €	1326NF BRUSHED NICKEL WALL CYLINDRICAL COVER + ECCENTRIC WITH SILENCER	
1326NFOC AAZ305667	1326NF ORO CEPILLADO FLORON CILINDRICO+EXCENTRICA+SILENCIADOR+FILTRO REJILLA		AGM-4D 261978	AGM-4D ASIENTO MONOMANDO DE TUERCA PARA 3105C GAUDI II	
23,90 €	1326NF BRUSHED GOLD WALL CYLINDRICAL COVER + ECCENTRIC WITH SILENCER		9,60 €	AGM-4D FOR 3105C GAUDI II	
1329 217140	1329 CROMO FLORON CUADRADO + EXCENTRICA STD		AGM-5D 261949	AGM-5D ASIENTO MONOMANDO DE TUERCA RS-CROSS	
20,10 €	1329 CHROME COVER PLATE SQUARE + ECCENTRIC STD		9,60 €	AGM-5D RS-CROSS	
1329NF AAZ302186	1329NF CROMO FLORON CUADRADO +EXCENTRICA+SILENCIADOR+FILTRO REJILLA		AGM-6I 253050	AGM-6I ASIENTO MONOMANDO DE TUERCA PARA ATICA	
20,10 €	1329NF CHROME WALL SQUARE COVER+ECCENTRIC+SILENCER+FILTRO		4,80 €	AGM-6I FOR ATICA	

1329NFM AAZ305258	1329NF NEGRO MATE FLORON CUADRADO +EX-CENTRICA+SILENCIADOR+FILTRO REJILLA		AGT 191418	AGT CROMO ASIENTO TERMOSTATICO CON ROSCA DERECHA	
35,00 €	1329NF BLACK MATTE WALL SQUARE COVER+EC-CENTRIC+SILENCER+FILTER		9,60 €	AGT SCREW SEAT WALL MOUNTED THERMOSTATIC	
1330 203622	1330 CROMO FLORON CONICO+EXCENTRICA STD+FILTRO REJILLA		AGTI 300259	AGTI ASIENTO TERMO. M18x1.5 LH ROSCA IZQUIERDA (ALOJAMIENTO VALVULA)	
12,40 €	1330 COVER PLATE + ECCENTRIC STD WITH FILTER		9,60 €	AGTI ASIENTO TERMOSTATICO CON ROSCA IZQUIERDA TERMOJET	
1331 261850	1331 CROMO PLACA FLORON PARA BV15 Y B350		AGTI02 AAZ302211	AGTI02 CROMO ASIENTO TERMO. CON ROSCA IZQ. PARA XX3402, XX3901 Y XX1202	
7,90 €	1331 COVER PLATE FOR BV15 & B350		9,60 €	AGTI02 CHROME SREW SEAT THERMOSTATIC WITH LEFT THREAD	
1335 AAZ300863	1335 CROMO FLORON CILINDRICO ALEXIA		AGTI02NM AAZ304271	AGTI02 NEGRO MATE ASIENTO TERMO. CON ROSCA IZQUIERDA	
6,20 €	1335 CHROME PLATE ESCUTCHEON CYLINDRICAL ALEXIA		16,70 €	AGTI02 BLACK MATTE SREW SEAT THERMOSTATIC WITH LEFT THREAD	
1335NM AAZ304006	1335 NEGRO MATE FLORON CILINDRICO ALEXIA		AGTI02NC AAZ305670	AGTI02 NIQUEL CEPILLADO ASIENTO TERMO. CON ROSCA IZQUIERDA	
10,50 €	1335 BLACK MATTE CYLINDRICAL WALL COVER ALEXIA		16,70 €	AGTI02 BRUSHED NICKEL SREW SEAT THERMOSTATIC WITH LEFT THREAD	
1336 AAZ300864	1336 CROMO FLORON CILINDRICO ALEXIA + EXCENTRICA STD CON FILTRO		AGTI02OC AAZ305669	AGTI02 ORO CEPILLADO ASIENTO TERMO. CON ROSCA IZQUIERDA	
13,80 €	1336 CHROME COVER PLATE CYLINDRICAL ALEXIA + ECCENTRIC STD + FILTER		16,70 €	AGTI02 BRUSHED GOLD SREW SEAT THERMOSTATIC WITH LEFT THREAD	
1336NM AAZ304005	1336 NEGRO MATE FLORON CILINDRICO ALEXIA + EXCENTRICA		E1/23/4 160248	E 1/2"-3/4" EXCENTRICA PARA SILENCIADOR	
18,60 €	1336 BALCK MATTE ESCUTCHEON + CYLINDRICAL ECCENTRIC ALEXIA"		7,40 €	E 1/2 -3/4 ECCENTRIC FOR SILENCER	
1338 AAZ304425	1338 CROMO FLORON CONICO + EXCENTRICA INOX STD CORTA		E1/23/4ST 160257	E 1/2"-3/4" ST EXCENTRICA STANDARD	
18,60 €	1338 CHROME COVER PLATE + STAINLESS STEEL ECCENTRIC STANDARD		7,40 €	E 1/2 -3/4 ST ECCENTRIC STANDARD	
AGX2 162519	AG (x2) CROMO ASIENOS GRUPO MURAL BIMANDO		FCB AAZ305159	FCB CROMO FLORON RECTANGULAR CAÑO PARA BAÑERA	
6,10 €	AG (x2) CHROME SCREW SEAT WALL MOUNTED MODELS		37,40 €	FCB CHROME RECTANGULAR COVER PLATE SPOUT FOR BATH	
AGM 187359	AGM CROMO ASIENTO GRUPO MONOMANDO		FCBNM AAZ305162	FCB NEGRO MATE FLORON RECTANGULAR CAÑO PARA BAÑERA	
4,80 €	AGM SCREW SEAT WALL MOUNTED SINGLE LEVER		66,00 €	FCB BLACK MATTE RECTANGULAR COVER PLATESPOUT FOR BATH	
AGM-2I 252816	AGM-2I CROMO ASIENTO MONOMANDO TUERCA ROSCA IZQUIERDA		FCBNC AAZ305160	FCB NIQUEL CEPILLADO FLORON RECTANGULAR CAÑO PARA BAÑERA	
4,80 €	AGM-2I CHROME SIT OF LEFT THREAD NUT		66,00 €	FCB BRUSHED NICKEL RECTANGULAR COVER PLATESPOUT FOR BATH	
AGM-2INM AAZ305697	AGM-2I NEGRO MATE ASIENTO MONO. TUERCA ROSCA IZQUIERDA		FCBOC AAZ305163	FCB ORO CEPILLADO FLORON RECTANGULAR CAÑO PARA EMPOTRADOS	
8,40 €	AGM-2I BLACK MATTE SIT OF LEFT THREAD NUT		66,00 €	FCB BRUSHED GOLD RECTANGULAR COVER PLATESPOUT FOR CONCEALED	
AGM-3I 261977	AGM-3I ASIENTO MONOMANDO DE TUERCA PARA 3108C Y 3117C GAUDI II		K1 47D300971	K1 CROMO PLACA EMPOTRADO 1 VIA KUATRO	
9,60 €	AGM-3I FOR 3108C Y 3117C GAUDI II		33,40 €	K1 COVER CONCEALED 1 WAY KUATRO	
K2 47C300970	K2 CROMO PLACA EMPOTRADO 2 VIAS KUATRO		KK23 227733	KK23 CROMO PLACA PARA 4723	
64,10 €	K2 COVER CONCEALED 2 WAYS KUATRO		217,30 €	KK23 CHROME COVER PLATE FOR 4723	
K23 230298	K23 CROMO PLACA PARA ETDI		KT1 AAZ302660	KT1 CROMO PLACA EMPOTRADO TERMOSTATICO 1 VIA	
205,30 €	K23 CHROME COVER PLATE FOR ETDI		56,80 €	KT1 CHROME WALL PLATE CONCEALED THERMOSTATIC 1 WAY	



K24 199068	K24 CROMO PLACA PARA ETD		KT2 AAZ302663	KT2 CROMO PLACA EMPOTRADO TERMOSTATICO 2 VIAS	
74,70 €	K24 CHROME COVER PLATE FOR ETD		109,00 €	KT2 CHROME WALL PLATE CONCEALED THERMOSTATIC 2 WAYS	
K3 47C301023	K3 CROMO PLACA EMPOTRADO 3 VIAS KUATRO		KTU1 AAZ302562	KTU1 CROMO PLACA EMPOTRADO TERMOSTATICO 1 VIA	
64,10 €	K3 COVER CONCEALED 3 WAYS KUATRO		56,80 €	KTU1 WALL PLATE CONCEALED THERMOSTATIC 1 WAY	
K33 226230	K33 CROMO PLACA REPISA PARA 4733MK Y 473302MK		KTU1NM AAZ303119	KTU1 NEGRO MATE PLACA EMP. TERMOSTATICO 1 VIA	
150,60 €	K33 CHROME COVER PLATE SHELF FOR 4733MK & 473302MK		103,00 €	KTU1 BLACK MATTE WALL PLATE CONCEALED THERMOSTATIC 1 WAY	
K33SCA 229155	K33SCA CROMO PLACA REPISA PARA 4733SCAMK Y 473302SCAMK		KTU1NC AAZ303118	KTU1 NIQUEL CEPILLADO PLACA EMP. TERMO. 1 VIA	
150,60 €	K33SCA CHROME COVER PLATE SHELF FOR 4733SCAMK & 473302SCAMK		103,00 €	KTU1 BRUSHED NICKEL WALL PLATE CONCEALED THERMOSTATIC 1 WAY	
K87 231279	K87 CROMO PLACA PARA ETI-ETI2		KTU1OC AAZ303120	KTU1 ORO CEPILLADO PLACA EMP. TERMOSTATICO 1 VIA	
89,00 €	K87 CHROME COVER PLATE FOR ETI/ETI2		103,00 €	KTU1 BRUSHED GOLD WALL PLATE CONCEALED THERMOSTATIC 1 WAY	
KAETDI 228885	KAETDI KIT AMPLIACION ETDI		KTU2 AAZ302563	KTU2 CROMO PLACA EMPOTRADO TERMOSTATICO 2 VIAS	
82,50 €	KAETDI-KIT EXTENSION ETDI		109,00 €	KTU2 WALL PLATE CONCEALED THERMOSTATIC 2 WAYS	
KAI3VCR AAZ301155	KAI3V CROMO KIT AMPLIAR INVERSOR 3 VIAS		KTU2NM AAZ303122	KTU2 NEGRO MATE PLACA EMP. TERMOSTATICO 2 VIAS	
26,50 €	KAI3V CHROMED KIT DIVERTER 3 WAYS		198,00 €	KTU2 BLACK MATTE WALL PLATE CONCEALED THERMOSTATIC 2 WAYS	
KAI3V 213459	KAI3V KIT AMPLIAR INVERSOR 3 VIAS		KTU2NC AAZ303121	KTU2 NIQUEL CEPILLADO PLACA EMP. TERMO. 2 VIAS	
26,50 €	KAI3V(3 WAY DIVERTER ANNEX SET)		198,00 €	KTU2 BRUSHED NICKEL WALL PLATE CONCEALED THERMOSTATIC 2 WAYS	
KALLP 213324	KALLP KIT AMPLIAR LLAVE PASO		KTU2OC AAZ303123	KTU2 ORO CEPILLADO PLACA EMP. TERMO. 2 VIAS	
23,50 €	KALLP (ANGLE VALVE ANNEX SET)		198,00 €	KTU2 BRUSHED GOLD WALL PLATE CONCEALED THERMOSTATIC 2 WAYS	
KALLU 214476	KALLU CROMO KIT ADAPTADOR ESTRIADO Z18 A Z20 LLAVE DE PASO		KTX1 AAZ302665	KTX1 CROMO PLACA EMPOTRADO TERMOSTATICO 1 VIA	
36,40 €	KALLU CHROME ANGLE VALVE AND ADAPTOR ANNEX SET		109,00 €	KTX1 WALL PLATE CONCEALED THERMOSTATIC 1 WAY	
KALLUNM AAZ305451	KALLU NEGRO MATE KIT ADAPTADOR ESTRIADO Z18 A Z20 LLAVE DE PASO		KTX1NM AAZ303112	KTX1 NEGRO MATE PLACA EMP. TERMOSTATICO 1 VIA	
63,40 €	KALLU BLACK MATTE ANGLE VALVE AND ADAPTOR ANNEX SET		198,00 €	KTX1 BLACK MATTE WALL PLATE CONCEALED THERMOSTATIC 1 WAY	
KALLUNC AAZ305453	KALLU NIQUEL CEPILLADO KIT ADAPTADOR ESTRIADO Z18 A Z20 LLAVE DE PASO		KTX1NC AAZ303111	KTX1 NIQUEL CEPILLADO PLACA EMP. TERMO. 1 VIA	
63,40 €	KALLU BRUSHED NICKEL ANGLE VALVE AND ADAPTOR ANNEX SET		198,00 €	KTX1 BRUSHED NICKEL WALL PLATE CONCEALED THERMOSTATIC 1 WAY	
KALLUOC AAZ305452	KALLU ORO CEPILLADO KIT ADAPTADOR ESTRIADO Z18 A Z20 LLAVE DE PASO		KTX1OC AAZ303113	KTX1 ORO CEPILLADO PLACA EMP. TERMOSTATICO 1 VIA	
63,40 €	KALLU BRUSHED GOLD ANGLE VALVE AND ADAPTOR ANNEX SET		198,00 €	KTX1 BRUSHED GOLD WALL PLATE CONCEALED THERMOSTATIC 1 WAY	
KB20 47A300943	KB20 CROMO PLACA EMPOTRADO LAVABO KUATRO		KTX2 AAZ302668	KTX2 CROMO PLACA EMP. TERMOSTATICO 2 VIAS	
57,40 €	KB20 COVER CONCEALED WASH BASIN KUATRO		109,00 €	KTX2 WALL PLATE CONCEALED THERMOSTATIC 2 WAYS	
KTX2NM AAZ303115	KTX2 NEGRO MATE PLACA EMP. TERMOSTATICO 2 VIAS		KX1NM AAZ303091	KX1 NEGRO MATE PLACA EMPOTRADO 1 VIA ALEXIA	
198,00 €	KTX2 BLACK MATTE WALL PLATE CONCEALED THERMOSTATIC 2 WAYS		68,10 €	KX1 BLACK MATTE COVER PLATE CONCEALED 1 WAY ALEXIA	
KTX2NC AAZ303114	KTX2 NIQUEL CEPILLADO PLACA EMP. TERMO. 2 VIAS		KX1NC AAZ303089	KX1 NIQUEL CEPILLADO PLACA EMPOTRADO 1 VIA ALEXIA	
198,00 €	KTX2 BRUSHED NICKEL WALL PLATE CONCEALED THERMOSTATIC 2 WAYS		68,10 €	KX1 BRUSHED NICKEL COVER PLATE CONCEALED 1 WAY ALEXIA	

KTX2OC AAZ303117	KTX2 ORO CEPILLADO PLACA EMP. TERMO. 2 VIAS		KX10C AAZ303053	KX1 ORO CEPILLADO PLACA EMPOTRADO 1 VIA ALEXIA	
198,00 €	KTX2 BRUSHED GOLD WALL PLATE CONCEALED THERMOSTATIC 2 WAYS		68,10 €	KX1 BRUSHED GOLD COVER PLATE CONCEALED 1 WAY ALEXIA	
KU1 AAZ302603	KU1 CROMO PLACA EMPOTRADO MONOMANDO 1 VIA		KX2 36C300951	KX2 CROMO PLACA EMPOTRADO 2 VIAS ALEXIA	
50,50 €	KU1 WALL PLATE CONCEALED SINGLE LEVER 1 WAY		64,10 €	KX2 CHROME COVER PLATE CONCEALED 2 WAYS ALEXIA	
KU1NM AAZ303133	KU1 NEGRO MATE PLACA EMP. MONOMANDO 1 VIA		KX2NM AAZ302921	KX2 NEGRO MATE PLACA EMPOTRADO 2 VIAS ALEXIA	
91,90 €	KU1 BLACK MATTE WALL PLATE CONCEALED SINGLE LEVER 1 WAY		116,60 €	KX2 NEGRO MATE PLACA EMPOTRADO 2 VIAS ALEXIA	
KU1NC AAZ303132	KU1 NIQUEL CEPILLADO PLACA EMP. MONOMANDO 1 VIA		KX2NC AAZ303092	KX2 NIQUEL CEPILLADO PLACA EMPOTRADO 2 VIAS ALEXIA	
91,90 €	KU1 BRUSHED NICKEL WALL PLATE CONCEALED SINGLE LEVER 1 WAY		116,60 €	KX2 BRUSHED NICKEL COVER PLATE CONCEALED 2 WAYS ALEXIA	
KU10C AAZ303135	KU1 ORO CEPILLADO PLACA EMP. MONOMANDO 1 VIA		KX2OC AAZ303093	KX2 ORO CEPILLADO PLACA EMPOTRADO 2 VIAS ALEXIA	
91,90 €	KU1 BRUSHED GOLD WALL PLATE CONCEALED SINGLE LEVER 1 WAY		116,60 €	KX2 BRUSHED GOLD COVER PLATE CONCEALED 2 WAYS ALEXIA	
KU2 AAZ302604	KU2 CROMO PLACA EMPOTRADO MONOMANDO 2 VIAS		KX3 36C301026	KX3 CROMO PLACA EMPOTRADO 3 VIAS ALEXIA	
96,00 €	KU2 WALL PLATE CONCEALED SINGLE LEVER 2 WAYS		64,10 €	KX3 COVER PLATE CONCEALED 3 WAYS ALEXIA	
KU2NM AAZ303137	KU2 NEGRO MATE PLACA EMP. MONOMANDO 2 VIAS		KX3NM AAZ303095	KX3 NEGRO MATE PLACA EMPOTRADO 3 VIAS ALEXIA	
174,50 €	KU2 BLACK MATTE WALL PLATE CONCEALED SINGLE LEVER 2 WAYS		116,60 €	KX3 BLACK MATTE COVER PLATE CONCEALED 3 WAYS ALEXIA	
KU2NC AAZ303136	KU2 NIQUEL CEPILLADO PLACA EMP. MONOMANDO 2 VIAS		KX3NC AAZ303094	KX3 NIQUEL CEPILLADO PLACA EMPOTRADO 3 VIAS ALEXIA	
174,50 €	KU2 BRUSHED NICKEL WALL PLATE CONCEALED SINGLE LEVER 2 WAYS		116,60 €	KX3 BRUSHED NICKEL COVER PLATE CONCEALED 3 WAYS ALEXIA	
KU2OC AAZ303138	KU2 ORO CEPILLADO PLACA EMP. MONOMANDO 2 VIAS		KX3OC AAZ303096	KX3 ORO CEPILLADO PLACA EMPOTRADO 3 VIAS ALEXIA	
174,50 €	KU2 BRUSHED GOLD WALL PLATE CONCEALED SINGLE LEVER 2 WAYS		116,60 €	KX3 BRUSHED GOLD COVER PLATE CONCEALED 3 WAYS ALEXIA	
KU3 AAZ302605	KU3 CROMO PLACA EMPOTRADO MONOMANDO 3 VIAS		KXB20 36A300952	KXB20 CROMO PLACA EMPOTRADO LAVABO ALEXIA	
96,00 €	KU3 WALL PLATE CONCEALED SINGLE LEVER 3 WAYS		57,40 €	KXB20 COVER PLATE CONCEALED WASH BASIN ALEXIA	
KU3NM AAZ303140	KU3 NEGRO MATE PLACA EMP. MONOMANDO 3 VIAS		KXB20NM AAZ303098	KXB20 NEGRO MATE PLACA EMPOTRADO LAVABO ALEXIA	
174,50 €	KU3 BLACK MATTE WALL PLATE CONCEALED SINGLE LEVER 3 WAYS		104,20 €	KXB20 BLACK MATTE COVER PLATE CONCEALED WASHBASIN ALEXIA	
KU3NC AAZ303139	KU3 NIQUEL CEPILLADO PLACA EMP. MONOMANDO 3 VIAS		KXB20NC AAZ303097	KXB20 NIQUEL CEPILLADO PLACA EMPOTRADO LAVABO ALEXIA	
174,50 €	KU3 BRUSHED NICKEL WALL PLATE CONCEALED SINGLE LEVER 3 WAYS		104,20 €	KXB20 BRUSHED NICKEL COVER PLATE CONCEALED WASHBASIN ALEXIA	
KU3OC AAZ303141	KU3 ORO CEPILLADO PLACA EMP. MONOMANDO 3 VIAS		KXB20OC AAZ303099	KXB20 ORO CEPILLADO PLACA EMPOTRADO LAVABO ALEXIA	
174,50 €	KU3 BRUSHED GOLD WALL PLATE CONCEALED SINGLE LEVER 3 WAYS		104,20 €	KXB20 BRUSHED GOLD COVER PLATE CONCEALED WASHBASIN ALEXIA	
KX1 36D300950	KX1 CROMO PLACA EMPOTRADO 1 VIA ALEXIA		PCA4 176370	PCA PLACA CUBRE AGUJERO 4"	
37,40 €	KX1 COVER PLATE CONCEALED 1 WAY ALEXIA		21,40 €	PCA COVER PLATE 4 SG9184	
PCA8 176379	PCA PLACA CUBRE AGUJERO 8"		T3/42C AAZ300861	T 3/4" 2C CROMO TUERCA SIMPLE 2 CARAS ALEXIA	
23,40 €	PCA COVER PLATE 5 SG9185		3,30 €	T 3/4 2C CHROME NUT SIMPLE 2 SIDES ALEXIA	
R1 AAD300944	R1 CROMO PLACA EMPOTRADO 1 VIA		T3/42CNM AAZ304008	T 3/4" 2C NEGRO MATE TUERCA SIMPLE 2 CARAS ALEXIA	
30,70 €	R1 CHROME COVER PLATE CONCEALED 1 WAY		5,70 €		

R2 AAC300945	R2 CROMO PLACA EMPOTRADO 2 VIAS		T3/42CNC AAZ305680	T 3/4" 2C NIQUEL CEPILLADO TUERCA SIMPLE 2 CARAS ALEXIA	
64,10 €	R2 CHROME COVER PLATE CONCEALED 2 WAYS		5,70 €	T 3/4 2C BRUSHED NICKEL NUT SIMPLE 2 SIDES ALEXIA	
R3 AAC301025	R3 CROMO PLACA EMPOTRADO 3 VIAS		T3/42COC AAZ305679	T 3/4" 2C ORO CEPILLADO TUERCA SIMPLE 2 CARAS ALEXIA	
64,10 €	R3 CHROME COVER PLATE CONCEALED 3 WAYS		5,70 €	T 3/4 2C BRUSHED GOLD NUT SIMPLE 2 SIDES ALEXIA	
RB20 AAA300946	RB20 CROMO PLACA LAVABO EMPOTRADO		T3/4NM AAZ305675	T 3/4" NEGRO MATE TUERCA SIMPLE	
57,40 €	RB20 CHROME COVER CONCEALED WASHBASIN		5,70 €	T 3/4 BLACK MATTE NUT SIMPLE	
RB20NM AAZ305693	RB20 NEGRO MATE PLACA LAVABO EMPOTRADO		T3/4NC AAZ305677	T 3/4" NIQUEL CEPILLADO TUERCA SIMPLE	
100,50 €	RB20 BLACK MATTE COVER CONCEALED WASHBASIN		5,70 €	T 3/4 BRUSHED NICKEL NUT SIMPLE	
RB20NC AAZ305695	RB20 NIQUEL CEPILLADO PLACA LAVABO EMPOTRADO		T3/4OC AAZ305676	T 3/4" ORO CEPILLADO TUERCA SIMPLE	
100,50 €	RB20 BRUSHED NICKEL COVER CONCEALED WASHBASIN		5,70 €	T 3/4 BRUSHED GOLD NUT SIMPLE	
RB20OC AAZ305694	RB20 ORO CEPILLADO PLACA LAVABO EMPOTRADO		T3/4 160220	T 3/4" CROMO TUERCA SIMPLE	
100,50 €	RB20 BRUSHED GOLD COVER CONCEALED WASHBASIN		3,30 €	T 3/4 CHROME SIMPLE NUT	
RB21H AAA300948	RB21H CROMO PLACA EMPOTRADO MANETA		T3/4T 191400	T 3/4" T CROMO TUERCA TERMOSTATICO	
33,40 €	RB21H CHROME COVER CONCEALED HANDLE		13,70 €	T 3/4 CHROME THERMOSTATIC NUT	
RB21HNM AAZ302924	RB21H NEGRO MATE PLACA EMPOTRADO MANETA		T3/4TNM AAZ303198	T 3/4" T NEGRO MATE TUERCA TERMOSTATICO	
60,70 €	RB21H BLACK MATTE COVER CONCEALED HANDLE		25,00 €	T 3/4 T BLACK MATTE THERMOSTATIC NUT	
RB21HNC AAZ303128	RB21H NIQUEL CEPILLADO PLACA EMP. MANETA		T3/4TNC AAZ303197	T 3/4" T NIQUEL CEPILLADO TUERCA TERMOSTATICO	
60,70 €	RB21H BRUSHED NICKEL COVER CONCEALED HANDLE		25,00 €	T 3/4 T BRUSHED NICKEL THERMOSTATIC NUT	
RB21HOC AAZ303129	RB21H ORO CEPILLADO PLACA EMPOTRADO MANETA		T3/4TOC AAZ303199	T 3/4" T ORO CEPILLADO TUERCA TERMOSTATICO	
60,70 €	RB21H BRUSHED GOLD COVER CONCEALED HANDLE		25,00 €	T 3/4 T BRUSHED GOLD THERMOSTATIC NUT	
RB21S AAA300947	RB21S CROMO PLACA EMPOTRADO CAÑO		TC3/4 202623	TC 3/4" TUERCA CORREDERA LATON	
33,40 €	RB21S CHROME COVER CONCEALED SPOUT		2,70 €	TC 3/4 SLIDING NUT IN BRASS	
RB21SNM AAZ302923	RB21S NEGRO MATE PLACA EMPOTRADO CAÑO		TCA 180753	TCA CROMO TAPA CUBRE AGUJEROS	
60,70 €	RB21S BLACK MATTE COVER CONCEALED SPOUT		8,90 €	TCA CHROME HOLE COVER	
RB21SNC AAZ303130	RB21S NIQUEL CEPILLADO PLACA EMPOTRADO CAÑO		RB21SOC AAZ303131	RB21S ORO CEPILLADO PLACA EMPOTRADO CAÑO	
60,70 €	RB21S BRUSHED NICKEL COVER CONCEALED SPOUT		60,70 €	RB21S BRUSHED GOLD COVER CONCEALED SPOUT	
1331NC AAZ306602	1331NC NIQUEL CEPILLADO PLACA FLORON REDONDO PARA BV15NC Y B350NC		1331OC AAZ306600	1331OC ORO CEPILLADO PLACA FLORON REDONDO PARA BV15OC Y B350OC	
13,90 €			13,90 €		
1331NM AAZ306599	1331NM NEGRO MATE PLACA FLORON REDONDO PARA BV15NM Y B350NM		1343 AAZ307660	1343 CROMO PLACA FLORON CUADRADO PARA BK350	
13,90 €			13,90 €		

1343NC AAZ307662	1343NC NIQUEL CEPILLADO PLACA FLORON CUADRADO PARA BK350NC	
13,90 €		
1343NM AAZ307659	1343NM NEGRO MATE PLACA FLORON CUADRADO PARA BK350NM	
13,90 €		

1343OC AAZ307661	1343OC ORO CEPILLADO FLORON CUADRADO PARA BRAZO DUCHA BK350OC	
13,90 €		
KTX1CUC AAZ307684	KTX1CUC COBRE CEPILLADO PLACA EMP. TERMO. 1 VIA	
198,00 €		

**VÁLVULAS, VARILLAS Y SIFONES VALVES AND ROD**

1167 108430	1167 VA CROMO VALVULA AUTOMATICA LATON	
18,50 €	1167 VA CHROME AUTOMATIC VALVE BRASS	
116902 AAZ303591	116902 VA CROMO VALVULA AUTOMATICA INOX.	
14,50 €	116902 VA CHROME AUTOMATIC VALVE INOX.	
1211 217761	1211 EN LAVABOS SIN REBOSADERO	
11,00 €	1211 WASH BASIN WITHOUT OVERFLOW	
121602P AAZ303592	121602P CROMO VALVULA QUICK CLACK PVC	
16,50 €	121602P CHROME CLICK CLACK PUSH WASTE PVC	
1217N 260304	1217N COLUMNA AUTOMATICA DESAGÜE BAÑERA	
128,30 €	1217N AUTOMATIC COLUMN DRAIN BATHTUB	
1218N 260313	1218N VALVULA DESAGÜE BAÑERA QUICK CLAC	
114,50 €	1218N VALVE DRAIN BATHTUB QUICK CLAC	
1219L 197106	1219L CROMO VALVULA CLICK CLACK LATON	
27,40 €	1219L CHROME CLICK CLACK PUSH WASTE BRASS	
1219LNM 99Z302477	1219L NEGRO MATE VALVULA CLICK CLACK LATON	
41,10 €	1219LNM CLICK CLACK PUSH WASTE BRASS MATT BLACK	
1219LNC 99Z302476	1219L NIQUEL CEPILLADO VALVULA CLICK CLACK LATON	
48,30 €	1219LNC CLICK CLACK PUSH WASTE BRASS BRUSHED NICKEL	
1219LOC 99Z302478	1219L ORO CEPILLADO VALVULA CLICK CLACK LATON	
48,30 €	1219LOC CLICK CLACK PUSH WASTE BRASS BRUSHED GOLD	
1267 260322	1267 TAPON PARA 1218N DESAGÜE BAÑERA QUICK CLAC	
17,30 €	1267 STOPPER FOR 1218N DARIN BATHTUB QUICK CLAC	
1269 213432	1269 TAPON PARA VALVULA CLICK CLACK 1219L	
13,80 €	1269 PLUG FOR 1219L WASH BASIN	

3790NC 99Z302331	3790 SIFON NIQUEL CEPILLADO CILINDRICO	
122,90 €	3790 BRUSHED NICKEL CYLINDRICAL SIPHON	
3790OC 99Z302333	3790 SIFON ORO CEPILLADO CILINDRICO	
122,90 €	3790 BRUSHED GOLD CYLINDRICAL SIPHON	
3794 AAZ301450	3794 LLAVE PASO 3/8" CON FILTRO PARA 2601, 2610, 4X31 Y 8102	
18,10 €	3794 STOPCOCK 3/8 WITH FILTER FOR 2601, 2610, 4X31 & 8102	
4719L 213477	4719L CROMO QUICK CLAC KUATRO & KUATRO NK	
35,30 €	4719L CHROME (QUICKCLAC KUATRO)	
4769 221775	4769 CROMO TAPON QUICK CLAC KUATRO	
17,20 €	4769 CHROME PLUG QUICK KUATRO	
4788 212109	4788 CROMO GRIFO PASO KUATRO DE G1/2" A G3/8"	
49,60 €	4788 CHROME STOPCOCK VALVE KUATRO OF 1/2 TO 3/8	
4790 212118	4790 SIFON CROMO KUATRO	
298,10 €	4790 CHROME SIPHON KUATRO	
9065 139905	9065 VA CROMO VALVULA AUTOMATICA PVC-INOX	
6,10 €	9065 VA CHROME AUTOMATIC VALVE PVC-INOX	
9067 213567	9067 TAPON VALVULA PVC CROMO	
4,80 €	9067 PLUG POP-UP WASTE CHROME	
9068 156271	9068 TAPON VALVULA LATON CROMO	
13,80 €	9068 POP-UP WASTE PLUG CHROME	
9069L 164724	9069L BRIDA LATON PARA VALVULA	
3,20 €	9069 ROD FASTENER FOR POP-UP BRASS	
9069P 156262	9069P BRIDA PLASTICO PARA VALVULA	
0,60 €	9069 ROD FASTENER TO POP-UP PVC	

1290 204405	1290 CROMO SIFON CONICO	
35,90 €	1290 CHROME BRASS SIPHON	
3788 198969	3788 GRIFO PASO CROMO CILINDRICO DE G1/2" A G3/8"	
16,50 €	3788 STOPCOCK CYLINDRICAL CHROME OF 1/2 TO 3/8	
3790 198960	3790 SIFON CROMO CILINDRICO	
65,80 €	3790 CHROME CYLINDRICAL SIPHON	
3790NM 992302332	3790 SIFON NEGRO MATE CILINDRICO	
100,90 €	3790 BLACK MATTE CYLINDRICAL SIPHON	
H1390 223575	H 1390 VALVULA VACIADO AUTOMATICO DE 1/2"	
106,10 €	H 1390 POP UP WASTE OF 1/2	
PC 173022	PC PORTACADENILLAS CROMO	
0,60 €	PC POP UP CHAINE HOLDER CHROME	
PCH 192642	PCH PORTACADENILLAS LATON	
2,40 €	PCH POP UP CHAINE HOLDER, BRASS	
PCVNM AAZ306677	PCVNM NEGRO MATE PORTACADENILLAS	
4,90 €		





9070-2 210048	9070-2 CROMO VARILLA PARTIDA STANDARD	
4,40 €	9070-2 CHROME TWO PIECE STANDARD ROD	
9072 208257	9072 CROMO VARILLA PARTIDA DRAKO Y RS-Q	
5,30 €	9072 CHROME SPLIT ROD DRAKO & RS-Q	
A1219L 261628	A1219L ACCIONAMIENTO VALVULA CLICK CLACK 1219L	
5,00 €	A1219L ACC. QUICK CLAC WASH BASIN 1219L	
H1380 218121	H 1380 CONJUNTO T DE CIRCUITO PARA RECIRCULACION	
63,10 €	H 1380 JUNCTION T CIRCUIT FOR RECYCLING	
PCO 205503	PCO PORTACADENILLAS LATON	
3,30 €	PCO CHAIN HOLDER IN BRASS ODIS	
VH 196170	VH VARILLA HORIZONTAL 328mm	
12,60 €	VH HORIZONTAL ROD VA1167 328mm	
121603P AAZ307804	121603P CROMO VALVULA QUICK CLACK PVC NF	
12,80 €		
121603PNM AAZ307805	121603PNM NEGRO MATE VALVULA QUICK CLACK PVC NF	
25,50 €		

**INVERSORES Y RACORES DIVERTER AND BRASS FITTING**

































1008SV 195657	1008 S/VOLANTE CROMO INVERSOR EMPOTRADO 3 VIAS	
124,50 €	1008 S/V CHROME INVERTER 3 OUTPUTS	
1008SVNM AAZ305580	1008 S/VOLANTE NEGRO MATE INVERSOR EMPOTRADO 3 VIAS	
217,90 €	1008 S/V BLACK MATTE INVERTER 3 OUTPUTS	
1008SVNC AAZ305582	1008 S/VOLANTE NIQUEL CEPILLADO INVERSOR EMPOTRADO 3 VIAS	
217,90 €	1008 S/V BRUSHED NICKEL INVERTER 3 OUTPUTS	
1008SVOC AAZ305581	1008 S/VOLANTE ORO CEPILLADO INVERSOR EMPOTRADO 3 VIAS	
217,90 €	1008 S/V BRUSHED GOLD INVERTER 3 OUTPUTS	
1009 215934	1009 CROMO INVERSOR 2 VIAS DE REPISA	
152,10 €	1009 CHROME 2 WAYS DIVERTER ON SHELF	
1570 154166	1570 INVERSOR EMPOTRADOS Y GRAN COCINA	
31,10 €	1570 DIVERTER FOR CONCEALED & GREAT KITCHEN	

4775 224808	4775 INVERSOR BAÑO KUATRO	
24,90 €	4775 INVERTER BATH KUATRO	
6970 235293	6970 INVERSOR BAÑO EMPOTRADO VULCANO	
17,80 €	6970 CONCEALED DIVERTER VULCANO	
6975 207798	6975 INVERSOR BAÑO VULCANO	
7,90 €	6975 BATH DIVERTER VULCANO	
DMX11/2 158331	DM (x1) M-G1/2"-M-G1/2" DOBLE MACHO	
6,20 €	DM (x1) 1/2 (DOUBLE MALE 1/2)	
EBRDSV 255759	EBRD S/V CROMO EMP. BAÑO DISTRI. XX33T-XX3302T-XX3303T	
213,60 €	EBRD S/VCONCEALED BATH DIVERTER OF XX33T	
MC75 AAZ301339	MC75 INVERSOR PARA XX85	
56,40 €	MC75 DIVERTER FOR XX85	











































1575 166884	1575 CROMO INVERSOR BAÑO AQUANOVA	
12,40 €	1575 DIVERTER AQUANOVA CHROME	
1875 252906	1875 INVERSOR BAÑO TITANIUM	
12,30 €	1875 INVERTER BATH TITANIUM	
3375 217410	3375 CROMO INVERSOR BAÑO	
7,90 €	3375 CHROME BATH DIVERTER	
3375NM AAZ304487	3375 NEGRO MATE INVERSOR BAÑO	
13,80 €	3375 BLACK MATTE BATH DIVERTER	
3375M 300029	3375M CROMO INVERSOR METALICO BAÑO	
32,30 €	3375M CHROME METAL INVERTER BATH	
3375MT 300208	3375MT CROMO INVERSOR METALICO TERMOSTATICO BAÑO	
32,30 €	3375MT CHROME METAL INVERTER THERMOSTATIC BATH	
4001 251412	4001 CARTUCHO INVERSOR CON CIERRE PARA TERMO. Ø7.65 Z20 Ø27 PARA XX3901	
28,00 €	4001 THERMOSTATIC INVERTER CARTRIDGE Ø27 FOR XX3901	
4002 252213	4002 CARTUCHO DISTRIBUIDOR SIN CIERRE Ø35 PARA 9328	
28,00 €	4002 DISTRIBUTOR CARTRIDGE Ø35 FOR 9328	
4003 AAZ300942	4003 CARTUCHO DISTRIBUIDOR 3 VIAS Ø7.65 Z20 Ø35	
28,00 €	4003 DISTRIBUTOR CARTRIDGE Ø35 3 WAYS	
4004 AAZ300972	4004 CARTUCHO DISTRIBUIDOR SIN CIERRE 45+45 Ø7.65 Z20 Ø35	
28,00 €	4004 DISTRIBUTOR CARTRIDGE Ø35 WITHOUT CLOSURE 45+45	
RD10MNM AAZ304272	RD10M NEGRO MATE RACOR DUCHA M-M12-G1/2" TERMOTECH	
35,40 €	RD10M BLACK MATTE SHOWER CONNECTOR M-M12-G1/2 THERMOTECH	
RD10MNC AAZ305672	RD10M NIQUEL CEPILLADO RACOR DUCHA M-M12-G1/2" TERMOTECH	
35,40 €	RD10M BRUSHED NICKEL SHOWER CONNECTOR M-M12-G1/2 THERMOTECH	
RD10MOC AAZ305671	RD10M ORO CEPILLADO RACOR DUCHA M-M12-G1/2" TERMOTECH	
35,40 €	RD10M BRUSHED GOLD SHOWER CONNECTOR M-M12-G1/2 THERMOTECH	
RD11MNC AAZ305585	RD11MNC NIQUEL CEPILLADO RACOR DUCHA CON IMAN H-G1/2"-M-G1/2"	
30,90 €		
RD11MNM AAZ305583	RD11MNM NEGRO MATE RACOR DUCHA CON IMAN H-G1/2"-M-G1/2"	
30,90 €		



















RD01M 162411	RD01M (RD) CROMO RACOR DUCHA M-G3/4"-M-G1/2"	
6,20 €	RD01M (RD) CHROME BRASS FITTING SHOWER M-G3/4--M-G1/2	
RD01P 242106	RD01P (RD PVC) CROMO RACOR DUCHA M-G3/4"-M-G1/2"	
1,80 €	RD01P (RD PVC) CHROME FITTING SHOWER M-G-3/4--M-G1/2	
RD02M 253041	RD02M CROMO RACOR DUCHA ATICA	
6,20 €	RD02M CHROME FITTING SHOWER ATICA	
RD04M 224934	RD04M (RDK) CROMO RACOR DUCHA M-G1/2"-M-G1/2"	
11,00 €	RD04M (RDK) CHROME FITTING SHOWER M-G1/2--M-G1/2	
RD05M 261976	RD05M CROMO RACOR DUCHA H-G3/4"-M-G1/2" GAUDI II	
12,30 €	RD05M CHROME FITTING SHOWER H-G3/4"--M-G1/2" GAUDI II	
RD06M 261958	RD06M CROMO RACOR DUCHA RS-CROSS	
11,00 €	RD06M CHROME RACOR SHOWER RS-CROSS	
RD07M AAZ300986	RD07M CROMO RACOR DUCHA H-G3/4"-M-G1/2"	
11,10 €	RD07M CHROME RACOR SHOWER H-G3/4--M-G1/2	
RD08P AAZ301966	RD08P RACOR MANGUERA Ø6.35mm MACHO G3/8"	
11,00 €	RD08P HOSE FITTING Ø6.35mm MALE G3/8"	
RD09M AAZ302194	RD09M CROMO RACOR DUCHA M-M14-M-G1/2" TERMOTECH	
20,30 €	RD08M CHROME SHOWER CONNECTOR M-M14-M-G1/2 TERMOTECH	
RD10M AAZ302649	RD10M CROMO RACOR DUCHA M-M12-M-G1/2" TERMOTECH	
20,30 €	RD10M CHROME SHOWER CONNECTOR M-M12-G1/2 TERMOTECH	
RD11M AAZ302655	RD11M CROMO RACOR DUCHA CON IMAN H-G1/2"-M-G1/2"	
67,10 €	RD11M CHROME FITTING SHOWER WITH MAGNET H-G1/2--M-G1/2	
RD12M AAZ306188	RD12M CROMO RACOR DUCHA M-G3/4"-M-M16x1 PARA XX1203-04	
6,20 €	RD12M CHROME RACOR SHOWER M-G3/4"-M-M16x1 FOR XX1203	
Y3/4 111444	Y 3/4" BIFURCACION	
22,60 €	Y 3/4 FORK	
RD11MOC AAZ305584	RD11MOC ORO CEPILLADO RACOR DUCHA CON IMAN H-G1/2"-M-G1/2"	
30,90 €		











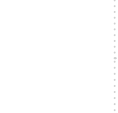





















COLUMNAS Y DISTINTIVOS COLUMNS					
1360X1 147512	1360 (x1) CROMO COLUMNITA BAÑO DE G1/2" A G3/4" DE 70mm		3761NENM AAZ303208	3761NE NEGRO MATE TAPA VOLANTE TERMOSTATICO NEUTRA	
30,90 €	1360 (x1) CHROME DELUXE PILLAR BATH OF M1/2 TO M3/4 OF 70mm		17,00 €	3761NE BLACK MATTE HANDLE WHEEL COVER NEUTRAL	
1360X2 227949	1360 (x2) CROMO COLUMNITAS BAÑO DE G1/2" A G3/4" DE 70mm		3761NENC AAZ303207	3761NE NIQUEL CEPILLADO TAPA VOLANTE TERMO. NEUTRA	
62,00 €	1360 (x2) CHROME DELUXE PILLAR BATH OF M1/2 TO M3/4 OF 70mm		17,00 €	3761NE BRUSHED NICKEL HANDLE WHEEL COVER NEUTRAL	
1361X1 213495	1361 (x1) SIN FILTRO ACUSTICO CROMO COLUMNITA BAÑO G1/2"-G3/4" 70mm		3761NEOC AAZ303209	3761NE ORO CEPILLADO TAPA VOLANTE TERMO. NEUTRA	
28,10 €	1361 (x1) W/O ACUSTIC FILTER CHROME DELUXE PILLAR BATH M1/2-M3/4 70mm		17,00 €	3761NE BRUSHED GOLD HANDLE WHEEL COVER NEUTRAL	
1361X2 227967	1361 (x2) SIN FILTRO ACUSTICO CROMO COLUMNITAS BAÑO G1/2"-G3/4" 70mm		4761X1 220209	4761 (x1) CROMO COLUMNITA KUATRO DE G1/2" A G3/4" DE 68mm	
56,00 €	1361 (x2) W/O ACUSTIC FILTER CHROME DELUXE PILLAR BATH M1/2-M3/4 70mm		88,50 €	4761 (x1) CHROME SIMPLE PILLAR KUATRO OF M1/2 TO M3/4 OF 68mm	
1370X2 202632	1370 (x2) COLUMNAS 800mm + SOPORTE		4761X2 227976	4761 (x2) CROMO COLUMNITAS KUATRO DE G1/2" A G3/4" DE 68mm	
464,20 €	1370 (x2) COLUMNS 800mm+SUPPORT		176,90 €	4761 (x2) CROMO COLUMNITA KUATRO DE M1/2" A M3/4" DE 68mm	
1370SX2 201219	1370 S (x2) COLUMNAS 800x25		4930 252915	4930 BASE EMBELLECEDORA KUATRO NK	
412,00 €	1370 S (x2) COLUMN 800X25		10,50 €	4930 BASE COVER KUATRO NK	
3330M-3 332301719	3330M-3 BASE EMBELLECEDORA METALICA M42x1 Ø50 PARA XX1902H -XX7902V		5530 234834	5530 CROMO BASE EMBELLECEDORA AQUANOVA FLY	
6,10 €	3330M-3 METAL EMBELLISHING BASE M42x1 Ø50 FOR XX1902H -XX7902V		4,80 €	5530 CHROME BASE COVER AQUANOVA FLY	
3761 201129	3761 CROMO TAPA VOLANTE TERMOSTATICO RS		5531 239622	5531 SUBBASE CARTUCHO FLY	
9,40 €	3761 CHROME THERMOSTATIC HANDLE INDEX RS		7,30 €	5531 SUB.BASE FLY CARTRIDGE	
3761NM AAZ303052	3761 NEGRO MATE TAPA VOLANTE TERMOSTATICO RS		6630M 260340	6630M BASE EMBELLECEDORA METALICA YPSILON	
17,00 €	3761 BLACK MATTE THERMOSTATIC HANDLE INDEX RS		5,00 €	6630M BASE COVER METALLIC YPSILON	
3761NC AAZ303051	3761 NIQUEL CEPILLADO TAPA VOLANTE TERMOSTATICO RS		6630P 251790	6630P BASE EMBELLECEDORA PLASTICO YPSILON	
17,00 €	3761 BRUSHED NICKEL THERMOSTATIC HANDLE INDEX RS		1,80 €	6630P BASE COVER PLASTIC YPSILON	
3761OC AAZ303055	3761 ORO CEPILLADO TAPA VOLANTE TERMOSTATICO RS		9523 AAZ303994	9523 CROMO DUCHITA PARA BIDE SAXX23	
17,00 €	3761 BRUSHED GOLD THERMOSTATIC HANDLE INDEX RS		37,20 €	9523 CHROME SHOWER FOR BIDETT SAXX23	
3761NE AAZ300630	3761NE CROMO TAPA VOLANTE TERMOSTATICO NEUTRA		DT1-BN 300070	DT1-BN DISTINTIVO BLANCO NEUTRO (C3)	
9,40 €	3761NE CROMO TAPA VOLANTE TERMOSTATICO NEUTRA		2,00 €	DT1-BN MARK WHITE NEUTRAL (C3)	
DT1-BRA 261487	DT1-BRA DISTINTIVO BLANCO (ROJO Y AZUL)		DT3-NCN AAZ305690	DT3-NCN DISTINTIVO NIQUEL CEPILLADO NEUTRO	
2,00 €	DT1-BRA MARK WHITE (RED Y BLUE)		3,50 €	DT3-NCN MARK BRUSHED NICKEL NEUTRAL	
DT1-CN 252825	DT1-CN DISTINTIVO CROMO NEUTRO		DT3-NMN AAZ305688	DT3-NMN DISTINTIVO NEGRO MATE NEUTRO	
2,00 €	DT1-CN MARK CHROMED NEUTRAL		3,50 €	DT3-NMN MARK BLACK MATTE NEUTRAL	
DT1-CRA 261492	DT1-CRA DISTINTIVO CROMO (ROJO Y AZUL)		DT3-OCN AAZ305689	DT3-OCN DISTINTIVO ORO CEPILLADO NEUTRO	
2,00 €	DT1-CRA MARK CHROME (RED & BLUE)		3,50 €	DT3-OCN MARK BRUSHED GOLD NEUTRAL	
DT1-CUCRA AAZ305719	DT1-CUCRA DISTINTIVO COBRE CEPILLADO (ROJO Y AZUL)		MC30 AAZ301316	MC30 CROMO BASE EMBELLECEDORA PARA XX76 Y XX85	
3,50 €	DT1-CUCRA MARK BRUSHED COPPER (RED & BLUE)		108,40 €	MC30 BASE WITH O-RING FOR XX85 / XX76	



DT1-NCN AAZ303181	DT1-NCN DISTINTIVO NIQUEL CEPILLADO NEUTRO		MC32NM AAZ305290	MC32 NEGRO MATE PLACA BASE EMBELLECEDORA PARA XX7602NM-XX8503NM	
3,70 €	DT1-NCN MARK BRUSHED NICKEL NEUTRAL		172,80 €	MC32 BLACK MATTE BASE COVER FOR XX7602NM-XX8503NM	
DT1-NMN AAZ303182	DT1-NMN DISTINTIVO NEGRO MATE NEUTRO		MCK30 AAZ301317	MCK30 BASE CON TORNILLOS PARA XX85K	
3,70 €	DT1-NMN MARK BLACK MATTE NEUTRAL		216,50 €	MCK30 BASE WITH SCREWS FOR XX85K	
DT1-OCN AAZ303183	DT1-OCN DISTINTIVO ORO CEPILLADO NEUTRO		SF1370 261772	SF1370 SOPORTE FIJACION REFORZAR COLUMNA BAÑO 1370	
3,70 €	DT1-OCN MARK BRUSHED GOLD NEUTRAL		64,90 €	SF1370 SUPPORT FIXATION COLUMN BATH 1370	
DT3-CN 253032	DT3-CN DISTINTIVO CROMO NEUTRO		TTM512 AAZ301856	TTM512 TORNILLO M5x12 FIJACION VOLANTE	
2,00 €	DT3-CN CHROME MARK NEUTRAL		5,40 €	TTM512 SCREW M5x12 HANDLE WHEEL FIXING	
BEMCO1 AAZ305792	BEMCO1 CROMO BASE CON JUNTA PARA XX7602		TTM550X2 AAZ301855	TTM550 (x2) TORNILLO M5x50 PLACA EMPO. TERMOSTATICO	
33,00 €			5,90 €	TTM550 (x2) SCREW M5x50 THERMOSTATIC CONCEALED PLATE	
BEMCO1NC AAZ305795	BEMCO1NC NIQUEL CEPILLADO BASE CON JUNTA PARA XX7602NC		BEMCO3 AAZ305800	BEMCO3 CROMO BASE CON JUNTA PARA XX8503	
58,70 €			33,00 €		
BEMCO1NM AAZ305793	BEMCO1NM NEGRO MATE BASE CON JUNTA PARA XX7602NM		BEMCO3NC AAZ305803	BEMCO3NC NIQUEL CEPILLADO BASE CON JUNTA PARA XX8503NC	
49,40 €			58,70 €		
BEMCO1OC AAZ305794	BEMCO1OC ORO CEPILLADO BASE CON JUNTA PARA XX7602OC		BEMCO3NM AAZ305801	BEMCO3NM NEGRO MATE BASE CON JUNTA PARA XX8503NM	
58,70 €			49,40 €		
BEMCO2 AAZ305796	BEMCO2 CROMO BASE CON JUNTA PARA 4X7602		BEMCO3OC AAZ305802	BEMCO3OC ORO CEPILLADO BASE CON JUNTA PARA XX8503OC	
33,00 €			58,70 €		
BEMCO2NC AAZ305799	BEMCO2NC NIQUEL CEPILLADO BASE CON JUNTA PARA 4X7602NC		BEMCO4 AAZ305804	BEMCO4 CROMO BASE CON JUNTA PARA 4X8502	
58,70 €			33,00 €		
BEMCO2NM AAZ305797	BEMCO2NM NEGRO MATE BASE CON JUNTA PARA 4X7602NM		BEMCO4NC AAZ305807	BEMCO4NC NIQUEL CEPILLADO BASE CON JUNTA PARA 4X8502NC	
49,40 €			58,70 €		
BEMCO2OC AAZ305798	BEMCO2OC ORO CEPILLADO BASE CON JUNTA PARA 4X7602OC		BEMCO4NM AAZ305805	BEMCO4NM NEGRO MATE BASE CON JUNTA PARA 4X8502NM	
58,70 €			49,40 €		
			BEMCO4OC AAZ305806	BEMCO4OC ORO CEPILLADO BASE CON JUNTA PARA 4X8502OC	
			58,70 €		

AIREADORES Y ROTULAS AERATOR & LIMITER						
1510 154228	1510 CROMO AIREADOR HEMBRA M22x1 TIPO S		4,80 €	1527 234762	1527 CROMO AIREADOR MACHO M24x1 LIMITADOR 3.7L	
	1510 CHROME AERATOR FEMALE M22x1 CLASS S			9,00 €	1527 AERATOR MALE M24x1 LIMITER 3.7L	
1511 261941	1511 AIREADOR MACHO M18.5x1 CACHE TIPO Z + LLAVE PARA 2603		6,90 €	1528 228795	1528 CROMO AIREADOR MACHO M24x1 LIMITADOR 5L	
	1511 AERATOR MALE M18.5x1 + KEY FOR 2603			7,90 €	1528 CHROME AERATOR MALE M24x1 LIMITER 5L	
1512 300084	1512 CROMO AIREADOR HEMBRA PARA 3021 Y 3029 GAUDI II		16,60 €	1529 229299	1529 CROMO AIREADOR MACHO M24x1 SPRAY LIMITADOR 1.7L	
	1512 CHROME AERATOR FEMALE FOR 3021 & 3029 GAUDI II			7,90 €	1529 CHROME AERATOR MALE M24x1 SPRAY 1.7L	
1515 228975	1515 AIREADOR MACHO M24x1 SLIM + LLAVE		6,20 €	1530 154246	1530 CROMO AIREADOR MACHO M28x1 TIPO D	
	1515 AERATOR MALE SLIM M24x1 + KEY			6,20 €	1530 CHROME AERATOR MALE M28x1 CLASS D	
1516 239469	1516 AIREADOR MACHO M24x1 COIN SLOT TIPO A		2,00 €	1531 250890	1531 AIREADOR MACHO M24x1 SLIM LIMITADOR 8L + LLAVE PARA 4702 Y 4710N	
	1516 AERATOR MALE M24x1 COIN SLOT CLASS A			8,70 €	1531 AERATOR MALE M24x1 SLIM 8L + KEY FOR 4702 & 4710N	
1517 239613	1517 AIREADOR MACHO M24x1 COIN SLOT LIMITADOR 8L		4,30 €	1532 250899	1532 AIREADOR MACHO M24x1 SLIM V + LLAVE PARA 4725	
	1517 AERATOR MALE M24x1 COIN SLOT LIMITER 8L			11,60 €	1532 AERATOR MALE M24x1 SLIM V + KEY FOR 4725	
1520 154237	1520 CROMO AIREADOR MACHO M24x1 TIPO B		4,60 €	1533 260052	1533 AIREADOR M16 PARA 7501 Y 7510	
	1520 CHROME AERATOR MALE M24x1 CLASS B			7,90 €	1533 AERATOR M16 FOR 7501 Y 7510	
1521 199356	1521 CROMO AIREADOR MACHO M24x1 ROM-PECHORROS		3,00 €	1534 252879	1534 CROMO AIREADOR MACHO M24x1 TIPO D	
	1521 CHROME AERATOR MALE M24x1 CASTS-POUTS			6,50 €	1534 CHROME AERATOR MALE M24x1 CLASS D	
1522 250719	1522 CROMO AIREADOR MACHO M24x1 TIPO A		4,60 €	1535 260376	1535 AIREADOR M24 PARA 7505	
	1522 CHROME AERATOR MALE M24x1 CLASS A			6,20 €	1535 AERATOR M24 FOR 7505	
1523 254436	1523 CROMO AIREADOR MACHO M24x1 LIMITADOR 8.3L		7,90 €	1536 260205	1536 AIREADOR MACHO M24x1 + LLAVE PARA X329N	
	1523 CHROME AERATOR MALE M24x1 FLOW LIMITER 8.3L			6,60 €	1536 AERATOR MALE M24x1 + KEY FOR X329N	
1524 259845	1524 CROMO AIREADOR HEMBRA M16x1 PARA XX21		7,90 €	1537 261782	1537 CROMO AIREADOR MACHO M24x1 LIMITADOR 7L	
	1524 CHROME AERATOR FEMALE M16x1 FOR XX21			8,20 €	1537 CHROME AERATOR MALE M24x1 LIMITER 7L	
1524NM AAZ303185	1524 NEGRO MATE AIREADOR HEMBRA M16x1 PARA XX21		14,40 €	1538 251988	1538 CROMO AIREADOR HEMBRA M22x1 TIPO A PARA XX1102 Y XX3601	
	1524 BLACK MATTE AERATOR FEMALE M16x1 FOR XX21			7,90 €	1538 AERATOR FEMALE M22x1 FOR XX1102 & XX3601	
1524NC AAZ303184	1524 NIQUEL CEPILLADO AIREADOR HEMBRA M16x1 PARA XX21		14,40 €	1539 261960	1539 CROMO AIREADOR HEMBRA PARA 6205 RS-CROSS	
	1524 BRUSHED NICKEL AERATOR FEMALE M16x1 FOR XX21			18,50 €	1539 AERATOR FEMALE FOR 6205 RS-CROSS	
1524OC AAZ303186	1524 ORO CEPILLADO AIREADOR HEMBRA M16x1 PARA XX21		14,40 €	1540 143419	1540 CROMO ROTULA HEMBRA M24x1 BIDE	
	1524 BRUSHED GOLD AERATOR FEMALE M16x1 FOR XX21			9,40 €	1540 CHROME KNEE FEMALE M24x1 BIDET	
1525 162456	1525 CROMO AIREADOR MACHO M24x1 ANTI-ROBO 8L		21,60 €	1541 AAZ300916	1541 AIREADOR MACHO M21.5x1 CACHE TIPO A	
	1525 CHROME AERATOR MALE M24x1 ANTI-THEFT DEVICE 8L			6,20 €	1541 AERATOR MALE M21.5x1 TYPE A	
1526 173049	1526 CROMO AIREADOR MACHO M24x1 7.5-9L TIPO Z		7,90 €	1545 228984	1545 CROMO ROTULA + AIREADOR HEMBRA M16x1 PARA RS-Q	
	1526 CHROME AERATOR MALE M24x1 FLOW LIMITER 8L CLASS Z			21,60 €	1545 CHROME KNEE + AERATOR FEMALE M16x1 FOR RS-Q	

1546 229011	1546 CROMO ROTULA + AIREADOR MACHO M18.5x1 CACHE + LLAVE PARA 2603		1600 AAZ303270	1600 AIREADOR INSERT 16/18 AFO A + LLAVE PARA 9564	
42,20 €	1546 CHROME KNEE + AERATOR MALE M18.5X1 CACHE + KEY FOR 2603		6,40 €	1600 AERATOR INSERT 16/18 AFO A + WRENCH FOR 9564	
1547 252402	1547 CROMO ROTULA + AIREADOR HEMBRA M16x1 PARA 340301-360302-7503		1601 AAZ303271	1601 AIREADOR 24 AFO FLAT + LLAVE PARA 9565	
21,70 €	1547 CHROME KNEE + AERATOR FEMALE M16x1 FOR 340301-360302-7503		6,40 €	1601 AERATOR 24 AFO FLAT + WRENCH FOR 9565	
1547NM AAZ303188	1547 NEGRO MATE ROTULA + AIREADOR HEMBRA M16x1 PARA 340301-3603		1602 AAZ303273	1602 CROMO AIREADOR M22x1 AFO + LLAVE PARA 9555	
39,60 €	1547 BLACK MATTE KNEE + AERATOR FEMALE M16x1 FOR 340301-3603		6,40 €	1602 CHROME AERATOR M22x1 AFO + WRENCH FOR 9555	
1547NC AAZ303187	1547 NIQUEL CEPILLADO ROTULA + AIREADOR HEMBRA M16x1 PARA 340301-3603		1603 AAZ303272	1603 AIREADOR M18x1 AFO SIL. + LLAVE PARA 9556	
39,60 €	1547 BRUSHED NICKEL KNEE + AERATOR FEMALE M16x1 FOR 340301-3603		6,40 €	1603 AERATOR 18X1 AFO SIL. + WRENCH FOR 9556	
1547OC AAZ303190	1547 ORO CEPILLADO ROTULA + AIREADOR HEMBRA M16x1 PARA 340301-3603		1606 AAZ304397	1606 AIREADOR MACHO M24x1 CACHE SPRAY 1.7L + LLAVE SOLESTOP	
39,60 €	1547 BRUSHED GOLD KNEE + AERATOR FEMALE M16x1 FOR 340301-3603		8,40 €	1606 AERATOR MALE M24X1 CACHE SPRAY 1.7L + KEY SOLESTOP	
1568 AAZ301891	1568 AIREADOR MACHO M18x1 SLIM TT + LLAVE PARA 7250		1607 AAZ304834	1607 AIREADOR MACHO M24x1 COIN SLOT LIMITADOR 5L	
4,30 €	1568 AERATOR MALE M18x1 + KEY FOR 7250		5,20 €	1607 AERATOR MALE M24x1 COIN SLOT LIMITER 5L	
1569CUC AAZ305723	1569 COBRE CEPILLADO AIREADOR CORTO M24x1 PARA C388401CUC		1608 AAZ304899	1608 AIREADOR MACHO M18.5x1 CACHE LIMITADOR 5L + LLAVE	
6,30 €	1594 BRUSHED COPPER AERATOR MALE M18x1 FOR C2404CUC		9,60 €	1608 AERATOR MALE M18.5x1 CACHE LIMITER 5L + KEY	
1569 AAZ303938	1569 CROMO AIREADOR CORTO M24x1 PARA C388401		1609 AAZ304902	1609 AIREADOR MACHO M18.5x1 CACHE LIMITADOR 8L + LLAVE	
3,50 €	1569 CHROM AIREATOR SHORT M24x1 FOR C388401		9,60 €	1609 AERATOR MALE M18.5x1 CACHE LIMITER 8L + KEY	
1589 241106	1589 CROMO AIREADOR MACHO M20x1 TIPO A PARA XX89 OSMOSIS		1610 AAZ304904	1610 AIREADOR MACHO M24x1 CACHE LIMITADOR 5L + LLAVE	
6,20 €	1589 CHROME AERATOR MALE M20x1 TYPE A FOR XX89 OSMOSIS		9,60 €	1610 AERATOR MALE M21x1 CACHE LIMITER 5L + KEY	
1592 252384	1592 AIREADOR HEMBRA M16x1 PARA 7503		1611 AAZ305843	1611 CROMO AIREADOR MACHO M18x1 LIMITADOR 5L PARA C2404	
7,90 €	1592 AERATOR M16x1 FOR 7503		7,90 €	1611 CHROME AERATOR MALE M18x1 5L FOR C2404	
1593 AAZ301154	1593 AIREADOR MACHO M24x1 SLIM LIMITADOR 4.5L + LLAVE		1612 AAZ305743	1612 AIREADOR MACHO M24x1 TIPO D + LLAVE PARA XX7602	
7,90 €	1593 AERATOR MALE M24x1 SLIM LIMITER 4.5L + KEY		4,70 €	1612 AERATOR MALE M24x1 TYPE D + KEY FOR XX7602	
1594CUC AAZ305724	1594 COBRE CEPILLADO AIREADOR MACHO M18x1 PARA C2404CUC		1613 AAZ305744	1613 CROMO AIREADOR MACHO M28x1 + LLAVE PARA 4X7602	
13,70 €	1594 BRUSHED COPPER AERATOR MALE M18x1 FOR C2404CUC		7,90 €	1613 CHROME AERATOR CHROME MALE M28x1 + KEY FOR 4X7602	
1594 AAZ301709	1594 CROMO AIREADOR MACHO M18x1 PARA C2404		1613NM AAZ305745	1613 NEGRO MATE AIREADOR MACHO M28x1 + LLAVE PARA 4X7602NM	
7,90 €	1594 CHROME AERATOR MALE M18x1 FOR C2404		13,70 €	1613 BLACK MATTE AERATOR CHROME MALE M28x1 + KEY FOR 4X7602NM	
1595 AAZ302058	1595 CROMO AIREADOR MACHO M20x1 LIMITADOR 8L PARA XX89 OSMOSIS		1613NC AAZ305747	1613 NIQUEL CEPILLADO AIREADOR MACHO M28x1 + LLAVE PARA 4X7602NC	
8,90 €	1595 AIREATOR MALE M20x1 8L FOR XX89 OSMOSIS		13,70 €	1613 BRUSHED NICKEL AERATOR CHROME MALE M28x1 + KEY FOR 4X7602NC	
1598 AAZ303268	1598 AIREADOR MACHO M18.5x1 CACHE LIMITADOR 3.7L + LLAVE		1613OC AAZ305746	1613 ORO CEPILLADO AIREADOR MACHO M28x1 + LLAVE PARA 4X7602OC	
7,90 €	1598 AERATOR MALE M18.5x1 CACHE LIMITER 3.7L + WRENCH		13,70 €	1613 BRUSHED GOLD AERATOR CHROME MALE M28x1 + KEY FOR 4X7602OC	
1599 AAZ303269	1599 AIREADOR MACHO M18.5x1 CACHE TIPO A + LLAVE		1614 AAZ305748	1614 AIREADOR MACHO M24x1 ROMPECHORROS + LLAVE PARA XX8503	
3,50 €	1599 AERATOR MALE M18.5x1 CACHE TYPE A + WRENCH		4,70 €	1614 AERATOR MALE M24x1 BREAKING JET+ KEY FOR XX8503	



1615 AAZ305749	1615 CROMO AIREADOR MACHO M24x1 ROMPE- CHORROS + LLAVE PARA 4X8502		ALT401 300064	ALT401 ANILLO ROJO LIMITADOR TEMP. PARA 40200-2 Y 40300-3	
4,70 €	1615 CHROME AERATOR MALE M24x1 BREAKING JET + KEY FOR 4X8502		3,30 €	ALT401 RING RED LIMTER TEMPERATURE FOR 40200-2 & 40300-3	
1615NM AAZ305750	1615 NEGRO MATE AIREADOR MACHO M24x1 ROMPECHORROS + LLAVE PARA 4X8502NM		ALT5 261920	ALT5 ANILLO BLOQUEO TEMPERATURA BLAU- THERM	
8,20 €	1615 BLACK MATTE AERATOR MALE M24x1 BREA- KING JET + KEY FOR 4X8502NM		3,30 €	ALT5 RING BLOCK TEMPERATURE BLAUTHERM	
1615NC AAZ305752	1615 NIQUEL CEPILLADO AIREADOR MACHO M24x1 ROMPECHORROS + LLAVE PARA 4X8502NC		ALT6 261983	ALT6 ANILLO BLANCO BLOQUEO TEMP. TER- MOGAUDI	
8,20 €	1615 BRUSHED NICKEL AERATOR MALE M24x1 BREAKING JET + KEY FOR 4X8502NC		3,30 €	ALT6 RING WHITE BLOCK TEMP. TERMOGAUDI	
1615OC AAZ305751	1615 ORO CEPILLADO AIREADOR MACHO M24x1 ROMPECHORROS + LLAVE PARA 4X8502OC		ALT7 AAZ302971	ALT7 ANILLO BLANCO LIMITADOR TEMP. XX2411 Y XX8712	
8,20 €	1615 BRUSHED GOLD AERATOR MALE M24x1 BREAKING JET + KEY FOR 4X8502OC		3,30 €	ALT7 WHITE LIMITER RING TEMP. FOR XX2411 & XX8712	
2640 261942	2640 CROMO ROTULA HEMBRA M18.5x1 PARA 2603		ALT8 AAZ303817	ALT8 ANILLO LIMITADOR TEMPERATURA RS- CROSS	
11,00 €	2640 CHROME KNEE FEMALE M18.5x1 FOR 2603		3,30 €	ALT8 ANILLO LIMITADOR TEMPERATURA RS- CROSS	
9340 261908	9340 ROTULA PARA 9303 RS-Q		ARD10 196179	ARD 10 VALVULA ANTIRRETORNO Ø10	
9,40 €	9340 BALL JOINT FOR 9303 RS-Q		6,20 €	ARD 10 ANTI-RETURN VALVE Ø10	
A7451 250845	A7451 AIREADOR MACHO M22x1 PARA 7451		ARD14 199230	ARD 14 ANTIRRETORNO (AUS) Ø14	
5,00 €	A7451 AERATOR MALE M22x1 FOR 7451		6,20 €	ARD 14 ANTI-RETURN VALVE (AUST) Ø14	
ALC1 210813	ALC1 ANILLO BLANCO LIMITADOR CAUDAL TERMODISEA		ARD15EMP 214755	ARD 15 EMPOTRADO ANTIRRETORNO Ø15	
3,30 €	ALC1 (WHITE)FLOW RATE LIMITER		6,20 €	ARD 15 CONCEALED ANTI-RETURN Ø15	
ALC3 227643	ALC3 ANILLO BLANCO LIMITADOR CAUDAL TERMOJET		ARD15 181680	ARD 15 VALVULA ANTIRRETORNO DUCHA Ø15	
3,00 €	ALC3 (WHITE) FLOW RATE LIMITER (TERMOJET)		4,80 €	ARD 15 ANTI-RETURN VALVE FOR SHOWER HEAD	
ALC5 AAZ302635	ALC5 ANILLO NEGRO LIMITADOR CAUDAL		ARD20 261990	ARD 20 VALVULA ANTIRRETORNO TERMOGAUDI	
3,30 €	ALC5 FLOW RATE LIMITER RING		6,20 €	ARD 20 ANTIRETURN TERMOGAUDI	
ALK1 222621	ALK1 ANILLO BLANCO LIMIT. TEMP. TERMOKUA- TRO/TERMOJET		ARD+C15 209427	ARD+C15 ANTIRRETORNO + LIMITADOR 15L Ø15	
3,30 €	ALK1 (WHITE) TEMPERATURE LIMITER (KUA+TJET)		4,80 €	ARD+C15 V. ANTI-RETURN + 15 LITRE LIMITER Ø15	
ALT1 210795	ALT1 ANILLO BLANCO LIMITADOR TEMP. TER- MODISIEA		ARD+C8 210111	ARD+C8 ANTIRRETORNO + LIMITADOR 8L Ø15	
3,30 €	ALT1 (WHITE) TEMPERATURE LIMITER		4,80 €	ARD+C8 ANTI-RETURN VAL+ 8 LITRE LIMITER Ø15	
ALT3 226221	ALT3 ANILLO ROJO BLOQUEO TEMPERATURA		JLC10 AAZ301142	JLC10 JUNTA LIMITADORA CAUDAL 10L AZUL CELESTE	
3,30 €	ALT3(RED) TEMPERATURE BLOCKER		4,80 €	JLC10 FLOW LIMTER 10L BLUE	
ALT350 300062	ALT350 ANILLO ROJO LIMITADOR TEMP. PARA 35200-2/3 Y 35300-2/3		JLC12 AAZ301285	JLC12 LIMITADOR CAUDAL 12L ROJO	
9,60 €	ALT350 RING RED LIMTER TEMPERATURE FOR 35200-2/3 & 35300-2/3		4,80 €	JLC12 LIMTER OF FLOW 12L RED	
ALT40 AAZ301337	ALT40 ANILLO LIMITADOR PARA XX85K		JLC3 234744	JLC3 JUNTA LIMITADORA CAUDAL 3L MARRON	
3,30 €	ALT40 RING LIMTER FOR XX85K		4,80 €	JLC3 FLOW LIMITER SEAL 3L BROWN	
ALT400 300063	ALT400 ANILLO ROJO LIMITADOR TEMP. PARA 40101 Y 40101-2		JLC6 234753	JLC6 JUNTA LIMITADORA CAUDAL 6L NEGRO	
3,30 €	ALT400 RING RED LIMTER TEMP. 40100 Y 40100-2		4,80 €	JLC6 FLOW LIMITER SEAL 6L BLACK	

JLC8 228786	JLC8 JUNTA LIMITADORA CAUDAL 8L BLANCO	
4,80 €	JLC8 FLOW LIMITER SEAL 8L WHITE	
JLC9 AAZ301287	JLC9 LIMITADOR CAUDAL 9L BLANCO	
4,80 €	JLC9 LIMTER OF FLOW 9L WHITE	
LAC 260493	LAC LIMITADOR TEMPERATURA CARTUCHO 9000N	
4,30 €	LAC LIMTER TEMPERATURE CARTRIDGE 9000N	
LC4 234825	LC4 LIMITADOR CAUDAL 4L ROSA	
4,80 €	LC4 FLOW LIMITER 4L PINK	
LC5 234807	LC5 LIMITADOR CAUDAL 5L VERDE	
4,80 €	LC5 FLOW LIMITER 5L GREEN	
LC9 234816	LC9 LIMITADOR CAUDAL 9L AMARILLO	
4,80 €	LC9 FLOW LIMITER 9L YELLOW	
1616 AAZ306307	1616 CROMO AIREADOR MACHO M24x1 ANTI-VANDALICO LIMITADOR 5L + LLAVE	
7,90 €		
1619 AAZ306984	1619 AIREADOR MACHO M24x1 SLIM LIMITADOR 3.7L + LLAVE	
7,10 €		
1621 AAZ307196	1621 AIREADOR MACHO M16.5x1 CACHE LIMITADOR 5L + LLAVE	
7,90 €		
ARD+C6 AAZ306981	ARD+C6 VALVULA ANTIRRETORNO + LIMITADOR 6L Ø15	
4,90 €		

PARD10 256362	PARD-10 PORTA-ANTIRRETORNO+ARD10+FILTRO (x2)	
20,40 €	PARD-10 PORTA-ANTIRRETURN+ARD10+FILTER (x2)	
PARD15 220740	PARD-15 CROMO PORTA-ANTIRRETORNO Ø15 H-G1/2"-M-G1/2"	
2,30 €	PARD-15 PORTA-ANTI *15	
PARDM-15 300038	PARDM-15 PORTA-ANTIRRETORNO Ø15 METALICO	
10,30 €	PARDM-15 PORTA-ANTIRRETURN Ø15 METALICO	
ROME16 AAZ301171	ROME16 ROMPECHORROS Ø16 PARA 7002	
1,40 €	ROME16 BREAKING JET Ø16 FOR 7002	
RR24X6 AAZ300474	RR24X6 ROMPECHORROS RECTANGULAR 24x6 PARA 4731 Y 4931	
23,40 €	RR24X6 BREAKING JET RECTANGULAR 24X6 FOR 4731 Y 4931	
1534OC AAZ308064	1534OC ORO CEPILLADO AIREADOR MACHO M24x1 TIPO D	
11,40 €		
1617 AAZ306467	1617 CROMO AIREADOR MACHO M10x1 DEL AGUA FILTRADA PARA 7589	
7,90 €		
1620 AAZ307195	1620 AIREADOR MACHO M16.5x1 CACHE LIMITADOR 8L + LLAVE	
7,90 €		
ALT9 AAZ307945	ALT9 ANILLO GRIS BLOQUEO TEMPERATURA C3	
3,30 €		
BJDN130D AAZ307893	BJDN130D KIT DE JUNTAS PARA BARRA EXTENSIBLE DN130D	
8,20 €		
BJDN132D AAZ307894	BJDN132D KIT DE JUNTAS PARA BARRA EXTENSIBLE DN132D	
8,20 €		

**BOLSAS Y LLAVES BAGS & KEYS**

BAC1 300039	BAC1 BOLSA ACCESORIOS XX11 Y XX36	
6,90 €	BAC1 BAG ACCESSORIES XX11 & XX36	
BAC2 300041	BAC2 BOLSA ACCESORIOS PARA 7501, 7503 Y 7510	
6,20 €	BAC2 ACCESORIES BAG FOR 7501, 7503 & 7510	
BAC2602 300057	BAC2602 BOLSA ACCESORIOS PARA 2602 AROLA	
7,20 €	BAC2602 BAG ACCESSORIES FOR 2602 AROLA	
BAC3 230424	BAC3 (BMD) BOLSA ACCESORIOS DRAKO	
6,20 €	BAC3 (BMD) BAG ACCES. DRAKO	

BAC6610 300045	BAC6610 BOLSA ACCESORIOS PARA 6610 YPSILON	
9,60 €	BAC6610 BAG ACCESSORIES FOR 6610 YPSILON	
BAC7 300054	BAC7 BOLSA ACCESORIOS PARA 7002 Y 7028 ECO	
4,30 €	BAC7 BAG ACCESSORIES FOR 7002 Y 7028 ECO	
BAC9 AAZ302972	BAC9 BOLSA ACCESORIOS PARA XX2411 Y XX8712	
21,80 €	BAC9 BOLSA ACCESORIOS PARA XX2411 Y XX8712	
BACC4733 300052	BACC4733 BOLSA ACCESORIOS PARA C4733	
17,90 €	BACC4733 ACCESORIES BAG FOR C4733	



BAC3319H 300044	BAC3319H BOLSA ACCESORIOS PARA XX19 Y XX79		21,80 €	BAC3319H BAG ACCESSORIES FOR XX19 & XX79	
BAC3369 300043	BAC3369 BOLSA ACCESORIOS PARA 3369 Y 9369		6,90 €	BAC3369 BAG ACCESSORIES FOR 3369 & 9369	
BAC3371 300048	BAC3371 BOLSA ACCESORIOS PARA 4771 KUATRO		6,90 €	BAC3371 ACCESSORIES BAG FOR 4771 KUATRO	
BAC4 300047	BAC4 BOLSA ACCESORIOS RS-CROSS		6,90 €	BAC4 BAG ACCESSORIES RS-CROSS	
BAC5 300050	BAC5 BOLSA ACCESORIOS PARA XX09 Y XX99		6,90 €	BAC5 BAG ACCESSORIES FOR XX99	
BAC6 300051	BAC6 BOLSA ACCESORIOS PARA XX19N		21,80 €	BAC6 BAG ACCESSORIES FOR XX19N	
BJB02 AAZ304517	BJB02 (x1) BOLSA JUNTA TORICA Ø38x2.5		4,50 €	BJB02 (x1) O-RING BAG Ø38xØ2.5	
BJB03 AAZ304518	BJB03 (x1) BOLSA JUNTA BASE Ø42.15		4,50 €	BJB03 (x1) BASE GASKET BAG Ø42.15	
BJB04 AAZ304519	BJB04 (x1) BOLSA JUNTA TORICA Ø34xØ2.5		4,50 €	BJB04 (x1) O-RING BAG Ø34xØ2.5	
BJB05 AAZ304520	BJB05 (x1) BOLSA JUNTA TORICA Ø34xØ3		4,50 €	BJB05 (x1) O-RING BAG Ø34xØ3	
BJB06 AAZ304521	BJB06 BOLSA CONJUNTO JUNTAS TORICAS URBAN CHIC		4,50 €	BJB06 JOINTS SET BAG FOR URBAN CHIC	
BJB07 AAZ304522	BJB07 (x1) BOLSA JUNTA TORICA Ø40.5xØ3		4,50 €	BJB07 (x1) O-RING BAG Ø40.5xØ3	
BJC620 AAZ304501	BJC620 BOLSA CONJUNTO JUNTAS CAÑO LAVABO Y BIDE RS-CROSS		1,40 €	BJC620 JOINTS SET BAG SPOUT WASH BASIN & BIDET RS-CROSS	
BJMC AAZ301340	BJMC BOLSA JUNTAS PARA XX76 Y XX85		11,30 €	BJMC BAG OF CON.O FOR XX85 / XX76	
BM3044 250692	BM3044 BOLSA ACCESORIOS 3044		49,90 €	BM3044 BAG ACCESSORIES 3044	
BM3310 222405	BM3310 BOLSA FIJACION 3310		6,20 €	BM3310 FIXING BAG 3310	
BACCR01 AAZ302951	BACCR01 ACCESORIOS INSTALACION PARA CR01		9,80 €	BACCR01 INSTALLATION KIT FOR CR01	
BEX 163446	BEX BOLSA ACCESORIOS PARA 2206EX		19,90 €	BEX FIXING BAG FOR 2206EX	
BGB 162474	BGB BOLSA ACCESORIOS PARA 7005 (x1)		6,20 €	BGB FIXING BAG FOR 7005 (x1)	
BGG 162537	BGG BOLSA ACCESORIOS PARA 7042		13,70 €	BGG FIXING BAG FOR 7042	
BJ1290 AAZ304481	BJ1290 BOLSA JUNTAS PARA 1290		4,50 €	BJ1290 BAG OF 1290	
BJB01 AAZ304485	BJB01 (x1) BOLSA JUNTA PLANA Ø44xØ38x2.5		4,50 €	BJB01 (x1) GASKET BAG Ø44xØ38x2.5	
BMK 230415	BMK BOLSA ACCESORIOS LAVABO KUATRO		9,40 €	BMK ACCESSORY BAG KUATRO BASIN	
BMNK 250710	BMNK BOLSA FIJACION LAVABO KUATRO NK		6,20 €	BMNK BAG FIXATION WASH BASIN KUATRO NK	
BMR 231468	BMR BOLSA FIJACION AROLA		9,40 €	BMR FIXING BAG AROLA	
BMX 228372	BMX BOLSA FIJACION XX19 Y XX79		21,60 €	BMX FIXING BAG XX19 & XX79	
BSU AAZ304484	BSU BOLSA ACCESORIOS SUJECION ESTANDAR LAVABO, BIDE Y FREGADERO		6,20 €	BSU STANDARD FIXATION ACCESSORIES BAG FOR BASIN, BIDET & SINK	
CS003 AAZ301765	CS003 CONJUNTO SUJECION + TORICA BASE		10,30 €	CS003 SET FIXATION+TORIC BASE	
LL1 229272	LL1 LLAVE CARTUCHO PROGRESIVO AROLA		32,50 €	LL1 CARTRIDGE KEY AROLA	
LL1500 167190	LL1500 LLAVE FIJACION AIREADOR		9,40 €	LL1500 KEY TO FIX AERATOR	
LL1516 239478	LL1516 LLAVE PARA AIREADOR COIN SLOT Y SLIM		1,00 €	LL1516 KEY COIN SLOT & SLIM	
LL1525 174363	LL1525 LLAVE CON LLAVERO		28,00 €	LL1525 KEY WITH KEYRING	

BMA 187080	BMA BOLSA ACCESORIOS UNIFICADA	
6,20 €	BMA BAG UNIFIED ACCESSORIES	
BME 199851	BME BOLSA ACCESORIOS FREGADERO Y BAÑO REPISA	
9,40 €	BME FIXING BAG SINK FOR MIXERS & BATH DECK MOUNTED	
BAC10 AAZ306767	BAC10 BOLSA FIJACION PARA XX23	
7,20 €		
BSU02 AAZ306154	BSU02 BOLSA ACCESORIOS SUJECION ESTAN- DAR CON TUERCA PALOMILLA	
6,20 €		
TCR01 AAZ305357	TCR01 TUERCA COLA ROSCADA Ø32	
2,40 €		
TP3/8X2 AAZ305358	TP 3/8" (x2) TUERCA PALOMILLA	
2,40 €		















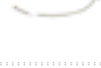



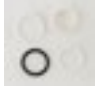

LL2 229263	LL2 LLAVE COLA AROLA	
32,50 €	LL2 AROLA BOTTOM KEY	
LLBF 182634	LLBF LLAVE BASE FREGADERO	
12,50 €	LLBF BASE KEY FOR SINK MIXER	
BJB08 AAZ306306	BJB08 (x1) BOLSA JUNTA PLANA Ø42xØ36x3.3	
4,50 €		
BSU03 AAZ306155	BSU03 BOLSA ACCESORIOS SUJECION ESTAN- DAR	
6,20 €		
TCR02R AAZ305840	TCR02R TUERCA RAPIDA COLA ROSCADA 1/2"	
2,40 €		















**JUNTAS, FILTROS Y TUERCAS CONNECTION**









220 300134	220 CONEXION FLEXIBLE G1/2" Ø15 G3/4" 500mm	
11,60 €	220 FLEXIBLE CONNECTION R1/2 Ø15 R3/4	
222 300137	222 CONEXION FLEXIBLE G1/2" Ø15 G1/2" 500mm	
10,30 €	222 FLEXIBLE CONNECTION R1/2 Ø15 R1/2	
224 120826	224 CONEXION FLEXIBLE DN8 M10x1 G3/8" 370mm AENOR	
7,90 €	224 SHORT FLEXIBLE CONNECT. DN8 M10x1 G3/8 370mm	
225 162438	225 CONEXION FLEXIBLE DN6 M10x1 G3/8" 370mm	
7,90 €	225 FLEXIBLE CONNEX. DN6 M10x1 G3/8 370mm	
228 187368	228 CONEXION FLEXIBLE CENTRAL XX19H Y XX79V DN6 M10x1 M15x1 350mm	
9,40 €	228 CENTRAL FLEX. CONNEX. XX19H & XX79V DN6 M10x1 M15x1 350mm	
229A 227085	229A CONEXION FLEXIBLE DN6 M10x1 G3/8" AZUL EXTRAIBLE 420mm	
7,90 €	229A CONEX. FLEX. M10 Ø10 R3/8 BLUE REMOVI- BLE 420mm	
229R 227076	229R CONEXION FLEXIBLE DN6 M10x1 G3/8" ROJA EXTRAIBLE 420mm	
7,90 €	229R FLEX. CONNEX. M10 Ø10 R3/8 RED REMO- VIBLE 420mm	
230 250674	230 CONEXION FLEXIBLE CORTA DN10 M15x1 M12x1 370mm PARA REPISA XX22	
10,30 €	230 FLEXIBLE SHORT CONNECTION M15 Ø14 M12 SHELF XX22	
232 261963	232 CONEXION FLEXIBLE DN8 M10x1 G3/8" 600mm PARA XX10	
7,90 €	232 FLEXIBLE CONNECTION M10 3/8 FOR XX10	













239R AAZ301712	239R CONEXION FLEXIBLE DN6 M10x1-G3/8" 500mm ROJA	
7,90 €	239R FLEXIBLE CONNECTION DN6 M10x1-G3/8 500mm RED	
240 AAZ302035	240 CONEXION FLEXIBLE DN8 M10x1-G1/2" 370mm	
7,90 €	240 FLEXIBLE HOSE DN8 M10x1-G1/2 370mm	
241 AAZ302996	241 CONEXION FLEXIBLE DN8 G3/8" M-H G1/2" 1000mm	
7,90 €	241 FLEXIBLE CONNECTION DN8 G3/8" M-H G1/2" 1000mm	
251 226239	251 CONEXION FLEXIBLE DN6 M10x1 G3/8" 420mm AZUL PARA 3319 + KUATRO	
7,90 €	251 FLEX. CONNEX. BLUE FOR 3319 +KUATRO M10 Ø10 R3/8 420mm	
252 216303	252 CONEXION FLEXIBLE DN6 M15x1 G3/8" 500mm PARA 9989 MONOMANDO	
9,40 €	252 CON. FLEX. 9989 MIXER DN6 M15x1 G3/8 500mm	
253 208644	253 CONEXION FLEXIBLE DN6 M15x1 G1/2" 500mm PARA 9989 TERMOSTATICO	
9,40 €	253 CON. FLEX. 9989 THERMOSTATIC DN6 M15x1 G1/2 500mm	
254 216276	254 CONEXION FLEXIBLE 2V-CAÑO DN8 G1/2" G3/4" 500mm	
15,30 €	254 CON.FLEX.2V-CAÑO DN8 G1/2 G3/4 500mm	
255 216285	255 CONEXION FLEXIBLE 2V-CAÑO DN8 G3/4" G3/4" 500mm	
15,30 €	255 CON.FLEX.2V-CAÑO DN8 G3/4 G3/4 500mm	
256 226248	256 CONEXION FLEXIBLE DN10 M12x1 G3/8" 370mm PARA 5516+2416	
9,40 €	256 FLEX. CONNEX. 5516+2416 M12 Ø14 R3/8	



233 261905	233 CONEXION FLEXIBLE DN10 M12x1 G3/4" 500mm PARA XX32-XX33		260 AAZ301767	260 CONEXION FLEXIBLE DN6 M8 Ø9 R3/8 750mm (R/A - AGUA PURIFICADA - 3 PIEZAS)	
11,60 €	233 FLEXIBLE CONNECTION M12 Ø14 R3/4 FOR XX32 Y XX33		10,20 €	260 FLEXIBLE CONNECTION DN6 M8 Ø9 R3/8 750mm	
234 261948	234 CONEXION FLEXIBLE DN8 G1/2" H-H 500mm PARA 6242 RS-CROSS		262 AAZ303995	262 CONEXION FLEXIBLE DN6 M-M8x1-H-G3/8" 600mm AENOR	
7,20 €	234 FLEXIBLE CONNECTION DN8 G1/2 FOR 6242 RS-CROSS		9,40 €	262 CONEXION FLEXIBLE DN10 M-M8x1-H-G3/8" 600mm AENOR	
235 261973	235 CONEXION FLEXIBLE R1/2 R1/2 PARA 3132 Y 3142 GAUDI II		263 AAZ304476	263 CONEXION FLEXIBLE FLX DN8 M-M10x1- H-G3/8" 600mm CSTB	
15,30 €	235 FLEXIBLE CONNECTION R1/2 R1/2 FOR 3132 & 3142 GAUDI II		9,40 €	263 FLEXIBLE HOSE FLX DN8 M-M10x1-H-G3/8 600mm CSTB	
236 261974	236 CONEXION FLEXIBLE M17 R1/2 PARA 3132 GAUDI II		264 AAZ304851	264 CONEXION FLEXIBLE FLX DN8 M-M12x1- H-G3/8" 600mm M. PLASTICO (CSTB)	
17,90 €	236 FLEXIBLE CONNECTION M17 R1/2 FOR 3132 GAUDI II		9,40 €	264 FLEXIBLE HOSE FLX DN8 M-M12x600-H-G3/8 600mm PLASTIC MESH (CSTB)	
237 AAZ300858	237 CONEXION FLEXIBLE DN6 M10x1-G3/8" 440mm M. ACERO INOX. (AENOR-CSTB)		265 AAZ304852	265 CONEXION FLEXIBLE DN8 M-M10x1-H-G3/8" 370mm M. ACERO INOX. ETIQ. ROJA (AENOR)	
7,90 €	237 FLEXIBLE CONNECTION DN6 M10x1-G3/8 440mm		9,40 €	265 FLEXIBLE HOSE DN8 M-M10x1-H-G3/8 370mm STAINLES STEEL MESH AND RED LABEL (AENOR)	
238 AAZ300859	238 CONEXION FLEXIBLE DN6 M10x1- G3/8" 600mm		2970 160364	2970 CONEXION MURAL BAÑO 19CM	
7,90 €	238 FLEXIBLE CONNECTION DN6 M10x1- G3/8 600mm		29,70 €	2970 WALL CONECCION (19CM) BATH	
239 AAZ301713	239 CONEXION FLEXIBLE DN6 M10x1-G3/8" 500mm		A3319H1 300461	A3319H1 BOLSA ARANDELAS ROZAMIENTO CAÑO FREG. EXTRAIBLE XX19H Y XX79V	
7,90 €	239 FLEXIBLE CONNECTION DN6 M10x1-G3/8 500mm		2,30 €	A3319H1 BAG WASHERS FOR EXTENSIBLE HOSE XX19H Y XX79V	
CRF1/20 AAZ305922	CRF1/20 COLA ROSCADA FIJACION CAÑO EMP. G1/2" 60mm		IV4752 261486	IV4752 INSERTO Y TORNILLO VOLANTE 4752 EN BOLSA	
17,90 €	CRF1/20 THREADED TAIL FIXATION SPOUT CON- CEALED G1/2 60mm		17,90 €	IV4752 HANDLE 4752 BAG	
CRF320 AAZ304358	CRF320 COLA ROSCADA FIJACION LAVABO ALTO YPSILON Ø32 90mm		J3306 238965	J3306 JUNTA PARA 3306/6906	
6,70 €	CRF320 THREADED TAIL FIXATION WASHBASIN HIGH YPSILON Ø32 90mm		0,50 €	J3306 SEAL FOR 3306	
FAC 160266	FAC FILTRO ACUSTICO CORTO		JC 217176	JC JUNTA CIERRE MONTURA 7000	
0,70 €	FAC SHORT ACUSTIC FILTER		2,40 €	JC SEAL FOR HEAD 7000	
FTE 229254	FTE FILTRO TERMOSTATICO EMPO. PARA XX23- XX24-XX27-XX87		JCF 201003	JCF JUNTA CON FILTRO REJILLA OVALADA PARA 2634 Y 2639	
28,00 €	FTE CONCEALED FILTER THERMOSTAITC FOR XX23-XX24-XX27-XX87		1,80 €	JCF JOINT WITH OVAL GRID FILTER FOR 2634 AND 2639	
FTE02 AAZ302974	FTE02 FILTRO TERMOSTATICO EMPO. PARA XX2411 Y XX8712		JCFA AAZ301284	JCFA JUNTA CON FILTRO (CON ALETAS)	
28,00 €	FTE02 FILTRO TERMOSTATICO EMPO. PARA XX2411 Y XX8712		2,20 €	JCFA O-RING WITH FILTER (WITH WINGS)	
H220 224763	H 220 CONEXION FLEXIBLE ANTIBACTERIANA FLX DN8 M10x1-G3/8" 500mm		JT3 175128	JT3 JUNTA TORICA PARA 1430	
11,00 €	H 220 ANTI BACTERIAL FLEX. CONNECT. FLX DN8 M10x1-G3/8" 500mm		1,40 €	JT3 JOINT FOR 1430	
JT3369 251169	JT3369 JUNTAS PARA 3369		JVITC 242124	JV ITC JUNTAS EN V PARA CAÑO CONFORMADO XX99-XX09	
0,20 €	JT3369 O-RINGS FOR 3369		0,60 €	JV ITC (COMPLETE KIT)	
JTE 175155	JTE JUNTA TORICA PARA CAÑOS ECO TIPO CE, CA, CAI		JV 160186	JV JUNTA EN V PARA CAÑO FUNDIDO XX09	
1,40 €	JTE JOINT FOR ECO SPOUTS TYPE CE, CA, CAI		1,80 €	JV JOINT IN V FOR CAST SPOUT XX09	
266 AAZ304897	266 CONEXION FLEXIBLE DN6 M10x1-G1/2" 420mm				
7,90 €					

EMPOTRADOS Y ALARGOS CONNECTION					
100502 AAZ302174	100502 DEPOSITO DE REPISA BAÑERA		CEMP3503NM AAZ304496	CEMP3503 NEGRO MATE CAMISA CARTUCHO EMPOTRADO Ø35 1 VIA	
699,00 €	100502 DEPOSITO DE REPISA BAÑERA		51,30 €	CEMP3503 BLACK MATTE SHIRT CARTRIDGE Ø35 CONCEALED 1WAY	
100502R AAZ302626	100502R REPISA PARA DEPOSITO BAÑERA		CEMP3503NC AAZ304524	CEMP3503 NIQUEL CEPILLADO CAMISA CARTUCHO EMPOTRADO Ø35 1 VIA	
204,70 €	100502R REPISA PARA DEPOSITO BAÑERA		51,30 €	CEMP3503 BRUSHED NICKEL SHIRT CARTRIDGE Ø35 CONCEALED 1WAY	
1780 256101	1780 CROMO KIT CASQUILLO EMBELLECEDOR EMP. PARA 3 VIAS (ETDI)		CEMP3503OC AAZ304523	CEMP3503 ORO CEPILLADO CAMISA CARTUCHO EMPOTRADO Ø35 1 VIA	
57,70 €	1780 CAPS EMB. CONCEALED 3V (ETDI)		51,30 €	CEMP3503 BRUSHED GOLD SHIRT CARTRIDGE Ø35 CONCEALED 1WAY	
1781 256110	1781 (x1) CROMO CASQUILLO EMBELLECEDOR EMP. PARA TEMP. Y CAUDAL		CEMPMO01 AAZ302979	CEMPMO01 CROMO CAMISA MONTURA 1703C 3/4" 1 VIA	
38,40 €	1781 CAPS EMB. CONCEALED Tº Y C		20,00 €	CEMPMO01 CHROME CERAMIC FRAME SHIRT 1703C 3/4" 1 WAY	
9989SC 200148	9989 SC CROMO SOPORTE DUCHA REPISA		CEMPMO01NM AAZ303201	CEMPMO01 NEGRO MATE CAMISA MONTURA 1703C 3/4" 1 VIA	
63,10 €	9989 SC CHROME LEDGE SUPPORT		35,20 €	CEMPMO01 BLACK MATTE CERAMIC FRAME SHIRT 1703C 3/4" 1 WAY	
ALLPZ18 AAZ305999	ALLPZ18 ADAPTADOR ESTRIADO LLAVE DE PASO Z18 DE Ø8 A Ø9		CEMPMO01NC AAZ303200	CEMPMO01 NIQUEL CEPILLADO CAMISA MONTURA 1703C 3/4" 1 VIA	
11,20 €	ALLPZ18 RIBBED ADAPTER FOR SHUT-OFF VALVE Z18 OF Ø8 TO Ø9		35,20 €	CEMPMO01 BRUSHED NICKEL CERAMIC FRAME SHIRT 1703C 3/4" 1 WAY	
ALLPZ20 AAZ306001	ALLPZ20 ADAPTADOR ESTRIADO LLAVE DE PASO DE Z18 A Z20 Ø7,6		CEMPMO01OC AAZ303202	CEMPMO01 ORO CEPILLADO CAMISA MONTURA 1703C 3/4" 1 VIA	
11,20 €	ALLPZ20 RIBBED ADAPTER FOR SHUT-OFF VALVE OF Z18 TO Z20 Ø7,6		35,20 €	CEMPMO01 BRUSHED GOLD CERAMIC FRAME SHIRT 1703C 3/4" 1 WAY	
CEMP3501 AAZ302077	CEMP3501 CROMO CAMISA CARTUCHO EMPOTRADO Ø35 2/3 VIAS		CEMPTE01 AAZ302973	CEMPTE01 CROMO CAMISA EMPOTRADO 1703T 1/2 VIAS	
29,40 €	CEMP3501 CHROME SHIRT CARTRIDGE CONCEALED Ø35 2/3 WAYS		29,40 €	CEMPTE01 CHROME CONCEALED SHIRT 1703T 1/2 WAYS	
CEMP3501NM AAZ304836	CEMP3501 NEGRO MATE CAMISA CARTUCHO EMPOTRADO Ø35 2/3 VIAS		CEMPTE01NM AAZ303204	CEMPTE01 NEGRO MATE CAMISA EMPOTRADO 1703T 1/2 VIAS	
51,30 €	CEMP3501 BLACK MATTE SHIRT CARTRIDGE CONCEALED Ø35 2/3 WAYS		51,30 €	CEMPTE01 BLACK MATTE CONCEALED SHIRT 1703T 1/2 WAYS	
CEMP3501NC AAZ304921	CEMP3501 NIQUEL CEPILLADO CAMISA CARTUCHO EMPOTRADO Ø35 2/3 VIAS		CEMPTE01NC AAZ303203	CEMPTE01 NIQUEL CEPILLADO CAMISA EMPOTRADO 1703T 1/2 VIAS	
51,30 €	CEMP3501 BRUSHED NICKEL SHIRT CARTRIDGE CONCEALED Ø35 2/3 WAYS		51,30 €	CEMPTE01 BRUSHED NICKEL CONCEALED SHIRT 1703T 1/2 WAYS	
CEMP3501OC AAZ304287	CEMP3501 ORO CEPILLADO CAMISA CARTUCHO EMPOTRADO Ø35 2/3 VIAS		CEMPTE01OC AAZ303206	CEMPTE01 ORO CEPILLADO CAMISA EMPOTRADO 1703T 1/2 VIAS	
51,30 €	CEMP3501 BRUSHED GOLD COVER CARTRIDGE CONCEALED Ø35 2/3 WAY		51,30 €	CEMPTE01 BRUSHED GOLD CONCEALED SHIRT 1703T 1/2 WAYS	
CEMP3502 AAZ302078	CEMP3502 CROMO CAMISA EMPOTRADO Ø35 DISTRIBUIDOR + LAVABO EMP.		EBRTSV 255750	EBRT S/V CROMO EMP. BAÑO TERMO. XX33T-XX3302T-XX3303T	
29,40 €	CEMP3502 CHROME SHIRT CONCEALED Ø35 DIVERTER + CONCEALED WASHBASIN		275,00 €	EBRT S/V CONCEALED BATH THERMOSTATIC OF XX33T	
CEMP3502NM AAZ303211	CEMP3502 NEGRO MATE CAMISA EMPOTRADO Ø35 DIST. + LAVABO EMP.		ETDI 227724	ETDI EMPOTRADO TERMOSTATICO 3V DUCHA	
51,30 €	CEMP3502 BLACK MATTE SHIRT CONCEALED Ø35 DIVERTER + CONCEALED WASHBASIN		465,90 €	ETDI CONCEALED 3-WAY THERMOSTATIC	
CEMP3502NC AAZ303210	CEMP3502 NIQUEL CEPILLADO CAMISA EMPOTRADO Ø35 DIST. + LAVABO EMP.		KA1V AAZ301364	KA1V CROMO ALARGO EMPOTRADO 1 VIA CAMISA CARTUCHO Ø35	
51,30 €	CEMP3502 BRUSHED NICKEL SHIRT CONCEALED Ø35 DIVERTER + WASHBASIN CONCEALED		33,80 €	KA1V CHROME EXTENSION CONCEALED 1WAY HOSE CARTRIDGE Ø35	
CEMP3502OC AAZ303212	CEMP3502 ORO CEPILLADO CAMISA EMPOTRADO Ø35 DIST. + LAVABO EMP.		KA1VNM AAZ305454	KA1V NEGRO MATE ALARGO EMPOTRADO 1 VIA CAMISA CARTUCHO Ø35	
51,30 €	CEMP3502 BRUSHED GOLD SHIRT CONCEALED Ø35 DIVERTER + CONCEALED WASHBASIN		59,10 €	KA1V BLACK MATTE EXTENSION CONCEALED 1WAY HOSE CARTRIDGE Ø35	
CEMP3503 AAZ302079	CEMP3503 CROMO CAMISA CARTUCHO EMPOTRADO Ø35 1 VIA		KA1VNC AAZ305456	KA1V NIQUEL CEPILLADO ALARGO EMPOTRADO 1 VIA CAMISA CARTUCHO Ø35	
29,40 €	CEMP3503 CHROME SHIRT CARTRIDGE CONCEALED Ø35 1 WAY		59,10 €	KA1V BRUSHED NICKEL EXTENSION CONCEALED 1WAY HOSE CARTRIDGE Ø35	

KA1VOC AAZ305455	KA1V ORO CEPILLADO ALARGO EMPOTRADO 1 VIA CAMISA CARTUCHO Ø35		KAETI03OC AAZ305465	KAETI03 ORO CEPILLADO KIT AMPLIACION TERMOSTATICOS XX8712	
59,10 €	KA1V BRUSHED GOLD EXTENSION CONCEALED 1 WAY HOSE CARTRIDGE Ø35		59,10 €	KAETI03 BRUSHED GOLD THERMOSTATIC EXTENSION KIT FOR XX8712	
KA2V AAZ301365	KA2V CROMO ALARGO EMPOTRADO 2 VIAS CAMISA CARTUCHO Ø35		KAETI04 AAZ303019	KAETI04 CROMO KIT AMPLIACION TERMOSTATICOS PARA XX2411	
62,70 €	KA2V CHROME EXTENSION CONCEALED 2 WAYS HOSE CARTRIDGE Ø35		33,80 €	KAETI04 CHROME THERMOSTATIC EXTENSION KIT FOR XX2411	
KA2VNM AAZ305457	KA2V NEGRO MATE ALARGO EMPOTRADO 2 VIAS CAMISA CARTUCHO Ø35		KAETI04NM AAZ305467	KAETI04 NEGRO MATE KIT AMPLIACION TERMOSTATICOS PARA XX2411	
109,90 €	KA2V BLACK MATTE EXTENSION CONCEALED 2 WAYS HOSE CARTRIDGE Ø35		59,10 €	KAETI04 BLACK MATTE THERMOSTATIC EXTENSION KIT FOR XX2411	
KA2VNC AAZ305460	KA2V NIQUEL CEPILLADO ALARGO EMPOTRADO 2 VIAS CAMISA CARTUCHO Ø35		KAETI04NC AAZ305469	KAETI04 NIQUEL CEPILLADO KIT AMPLIACION TERMOSTATICOS PARA XX2411	
109,90 €	KA2V BRUSHED NICKEL EXTENSION CONCEALED 2 WAYS HOSE CARTRIDGE Ø35		59,10 €	KAETI04 BRUSHED NICKEL THERMOSTATIC EXTENSION KIT FOR XX2411	
KA2VOC AAZ305459	KA2V ORO CEPILLADO ALARGO EMPOTRADO 2 VIAS CAMISA CARTUCHO Ø35		KAETI04OC AAZ305468	KAETI04 ORO CEPILLADO KIT AMPLIACION TERMOSTATICOS PARA XX2411	
109,90 €	KA2V BRUSHED GOLD EXTENSION CONCEALED 2 WAYS HOSE CARTRIDGE Ø35		59,10 €	KAETI04 BRUSHED GOLD THERMOSTATIC EXTENSION KIT FOR XX2411	
KA3V AAZ301366	KA3V CROMO ALARGO EMPOTRADO 3 VIAS CAMISA CARTUCHO Ø35		PME AAZ302052	PME PLANCHA MONTAJE EMPOTRADO	
62,70 €	KA3V CHROME EXTENSION CONCEALED 3 WAYS HOSE CARTRIDGE Ø35		24,60 €	PME MOUNTING PLATE CONCEALED	
KA3VNM AAZ305461	KA3V NEGRO MATE ALARGO EMPOTRADO 3 VIAS CAMISA CARTUCHO Ø35		SMC85 AAZ301338	SMC85 SOPORTE DE TELEDUCHA PARA XX85	
109,90 €	KA3V BLACK MATTE EXTENSION CONCEALED 3 WAYS HOSE CARTRIDGE Ø35		69,60 €	SMC85 SUPPORT OF TELESOWER FOR XX85	
KA3VNC AAZ305463	KA3V NIQUEL CEPILLADO ALARGO EMPOTRADO 3 VIAS CAMISA CARTUCHO Ø35		TECNOBOX02 AAZ305292	TECNOBOX02 CUERPO EMPO. PARA XX7602-4X8502-XX8503	
109,90 €	KA3V BRUSHED NICKEL EXTENSION CONCEALED 3 WAYS HOSE CARTRIDGE Ø35		120,30 €	TECNOBOX02 CUERPO EMPO. PARA XX7602-4X8502-XX8503	
KA3VOC AAZ305462	KA3V ORO CEPILLADO ALARGO EMPOTRADO 3 VIAS CAMISA CARTUCHO Ø35		U0000 AAZ300890	U0000 RS-BOX UNIVERSAL CUERPO EMPOTRADO	
109,90 €	KA3V BRUSHED GOLD EXTENSION CONCEALED 3 WAYS HOSE CARTRIDGE Ø35		106,80 €	U0000 RS-BOX UNIVERSAL BODY CONCEALED	
KAB AAZ301367	KAB CROMO ALARGO EMPO. LAVABO CAMISA CARTUCHO Ø35		U051 AAZ301031	U051 VOLANTE DE TEMPERATURA CON ANILLO PARA RS-BOX	
38,60 €	KAB CHROME EXTENSION CONCEALED OF WASH BASIN HOSE CARTRIDGE Ø35		83,80 €	U051 HANDLE OF TEMPERATURE WITH RING FOR RS-BOX	
KABNM AAZ305114	KAB NEGRO MATE ALARGO EMPO. LAVABO CAMISA CARTUCHO Ø35		U059 AAZ301032	U059 VOLANTE REGULADOR DE CAUDAL PARA RS-BOX	
67,60 €	KAB BLACK MATTE EXTENSION CONCEALED OF WASH BASIN HOSE CARTRIDGE Ø35		83,80 €	U059 HANDLE REGULATOR OF FLOW FOR RS-BOX	
KABNC AAZ305115	KAB NIQUEL CEPILLADO ALARGO EMPO. LAVABO CAMISA CARTUCHO Ø35		U1570 AAZ301049	U1570 INVERSOR MONOMANDO PARA RS-BOX	
67,60 €	KAB BRUSHED NICKEL EXTENSION CONCEALED OF WASH BASIN HOSE CARTRIDGE Ø35		42,80 €	U1570 DIVERTER SINGLE LEVER FOR RS-BOX	
KABOC AAZ305117	KAB ORO CEPILLADO ALARGO EMPO. LAVABO CAMISA CARTUCHO Ø35		U1700 AAZ301043	U1700 CARTUCHO TERMOSTATICO PARA RS-BOX	
67,60 €	KAB BRUSHED GOLD EXTENSION CONCEALED OF WASH BASIN HOSE CARTRIDGE Ø35		44,40 €	U1700 CARTRIDGE THERMOSTATIC FOR RS-BOX	
KAETI03 AAZ302564	KAETI03 CROMO KIT AMPLIACION TERMOSTATICOS PARA XX8712		U35000-2 AAZ301040	U35000-2 CARTUCHO MONOMANDO Ø35 PARA RS-BOX	
33,80 €	KAETI03 CHROME THERMOSTATIC EXTENSION KIT FOR XX8712		24,70 €	U35000-2 CARTRIDGE SINGLE LEVER Ø35 FOR RS-BOX	
KAETI03NM AAZ305464	KAETI03 NEGRO MATE KIT AMPLIACION TERMOSTATICOS XX8712		U4000 AAZ301044	U4000 CARTUCHO INVERSOR PARA RS-BOX	
59,10 €	KAETI03 BLACK MATTE THERMOSTATIC EXTENSION KIT FOR XX8712		24,70 €	U4000 CARTRIDGE DIVERTER FOR RS-BOX	
KAETI03NC AAZ305466	KAETI03 NIQUEL CEPILLADO KIT AMPLIACION TERMOSTATICOS XX8712		UALT AAZ301045	UALT ANILLO LIMITADOR DE CARTUCHO TERMOSTATICO PARA RS-BOX	
59,10 €	KAETI03 BRUSHED NICKEL THERMOSTATIC EXTENSION KIT FOR XX8712		2,40 €	UALT RING LIMTER OF CARTRIDGE THERMOSTATIC FOR RS-BOX	

UK1 AAZ301035	UK1 CROMO PLACA EMPOTRADA MONOMANDO 1 VIA PARA RS-BOX		XX1503NC AAZ303086	XX1503 NIQUEL CEPILLADO BAÑO-DUCHA EMP. 3 VIAS S2 CON CAJA	
105,80 €	UK1 COVER CONCEALED SINGLE LEVER 1 WAY FOR RS-BOX		129,00 €	XX1503 BRUSHED NICKEL BATH-SHOWER CONCEALED 3 WAYS WITH BOX S2	
UK2 AAZ301042	UK2 CROMO PLACA EMPOTRADA MONOMANDO 2 VIAS PARA RS-BOX		XX1503OC AAZ303088	XX1503 ORO CEPILLADO BAÑO-DUCHA EMP. 3 VIAS S2 CON CAJA	
108,10 €	UK2 COVER CONCEALED SINGLE LEVER 2 WAYS FOR RS-BOX		129,00 €	XX1503 BRUSHED GOLD BATH-SHOWER CONCEALED 3 WAYS WITH BOX S2	
UK87S AAC300908	UK87 S SET TERMOSTATICO BAÑO EMPOTRADO		XX1801 AAZ301876	XX1801 CROMO DUCHA EMPOTRADO 1 VIA S2 CON CAJA	
282,60 €	UK87 S SET THERMOSTATIC BATH CONCEALED		37,60 €	XX1801 CHROME SHOWER CONCEALED 1 WAY S2 WITH BOX	
UKT2 AAZ301036	UKT2 CROMO PLACA EMPOTRADA TERMOSTATICA 2 VIAS PARA RS-BOX		XX1801NM AAZ303074	XX1801 NEGRO MATE DUCHA EMPOTRADO 1 VIA S2 CON CAJA	
119,00 €	UKT2 COVER CONCEALED THERMOSTATIC 2 WAYS FOR RS-BOX		68,30 €	XX1801 BLACK MATTE SHOWER WALL-MOUNTED 1w WITH BOX S2	
UPROL AAZ301050	UPROL PROLONGACION 10mm PARA RS-BOX		XX1801NC AAZ303105	XX1801 NIQUEL CEPILLADO DUCHA EMP. 1 VIA S2 CON CAJA	
52,30 €	UPROL PROLONGACION 10 MM FOR RS-BOX		68,30 €	XX1801 BRUSHED NICKEL SHOWER WALL-MOUNTED 1w WITH BOX S2	
UR1 AAZ301033	UR1 CROMO PLACA EMPOTRADA MONOMANDO 1 VIA PARA RS-BOX		XX1801OC AAZ303106	XX1801 ORO CEPILLADO DUCHA EMP. 1 VIA S2 CON CAJA	
92,00 €	UR1 COVER CONCEALED SINGLE LEVER 1 WAY FOR RS-BOX		68,30 €	XX1801 BRUSHED GOLD SHOWER WALL-MOUNTED 1w WITH BOX S2	
UR2 AAZ301041	UR2 PLACA EMPOTRADA MONOMANDO 2 VIAS PARA RS-BOX		XX20CF AAZ301880	XX20CF CROMO LAVABO EMPO. PARA CAÑO FUNDIDO S2 CON CAJA	
95,80 €	UR2 COVER CONCEALED SINGLE LEVER 2 WAYS FOR RS-BOX		78,40 €	XX20CF CHROME WASHBASIN WITH MOLDED SPOUT S2 WITH BOX	
UR87S AAC300907	UR87 S SET TERMOSTATICO BAÑO EMPOTRADO		XX20CFNM AAZ303101	XX20CF NEGRO MATE LAV. EMP. PARA CAÑO FUNDIDO S2 CON CAJA	
270,30 €	UR87 S SET THERMOSTATIC BATH CONCEALED		142,30 €	XX20CF BLACK MATTE WASHBASIN WITH MOLDED SPOUT WITH BOX S2	
URT2 AAZ301034	URT2 CROMO PLACA EMPOTRADA TERMOSTATICA 2 VIAS PARA RS-BOX		XX20CFNC AAZ303100	XX20CF NIQUEL CEPILLADO LAV. EMP. PARA CAÑO FUNDIDO S2 CON CAJA	
107,20 €	URT2 COVER CONCEALED THERMOSTATIC 2 WAYS FOR RS-BOX		142,30 €	XX20CF BRUSHED NICKEL WASHBASIN WITH MOLDED SPOUT WITH BOX S2	
UTSC AAZ301046	UTSC TUERCA DE CARTUCHO INVERSOR PARA RS-BOX		XX20CFOC AAZ303102	XX20CF ORO CEPILLADO LAV. EMP. PARA CAÑO FUNDIDO S2 CON CAJA	
4,70 €	UTSC NUT OF CARTRIDGE DIVERTER FOR RS-BOX		142,30 €	XX20CF BRUSHED GOLD WASHBASIN WITH MOLDED SPOUT WITH BOX S2	
XX1502 AAZ301877	XX1502 CROMO BAÑO-DUCHA EMPOTRADO 2 VIAS S2 CON CAJA		XX20CT AAZ301879	XX20CT CROMO LAVABO EMPO. PARA CAÑO TUBO S2 CON CAJA	
70,00 €	XX1502 CHROME BATH-SHOWER CONCEALED 2 WAYS S2 WITH BOX		78,40 €	XX20CT CHROME CONCEALED WASHBASIN SPOUT TUBO S2 WITH BOX	

XX1502NM AAZ302920	XX1502 NEGRO MATE BAÑO-DUCHA EMPO. 2 VIAS S2 CON CAJA	
127,20 €	XX1502 NEGRO MATE BAÑO DUCHA EMPO. 2 VIAS S2 CON CAJA	
XX1502NC AAZ303084	XX1502 NIQUEL CEPILLADO BAÑO-DUCHA EMP. 2 VIAS S2 CON CAJA	
127,20 €	XX1502 BRUSHED NICKEL BATH-SHOWER CONCEALED 2 WAYS WITH BOX S2	
XX1502OC AAZ303085	XX1502 ORO CEPILLADO BAÑO-DUCHA EMP. 2 VIAS S2 CON CAJA	
127,20 €	XX1502 BRUSHED GOLD BATH-SHOWER CONCEALED 2 WAYS WITH BOX S2	
XX1503 AAZ301878	XX1503 CROMO BAÑO DUCHA EMPOTRADO 3 VIAS S2 CON CAJA	
70,90 €	XX1503 BATH-SHOWER CONCEALED 3 WAYS S2 WITH BOX	
XX1503NM AAZ303087	XX1503 NEGRO MATE BAÑO-DUCHA EMP. 3 VIAS S2 CON CAJA	
129,00 €	XX1503 BLACK MATTE BATH-SHOWER CONCEALED 3 WAYS WITH BOX S2	
XX2411NC AAZ303108	XX2411 NIQUEL CEPILLADO TERMO. EMP. 1 VIA CON CAJA	
215,10 €	XX2411 BRUSHED NICKEL CONCEALED THERMOSTATIC 1 WAY WITH BOX	
XX2411OC AAZ303110	XX2411 ORO CEPILLADO TERMO. EMP. 1 VIA CON CAJA	
215,10 €	XX2411 BRUSHED GOLD CONCEALED THERMOSTATIC 1 WAY WITH BOX	
XX8712 AAZ302561	XX8712 CROMO EMPOTRADO TERMO. 2 VIAS CON CAJA	
118,30 €	XX8712 CONCEALED THERMOSTATIC 2 WAYS WITH BOX	
A91070 91Z307125	A91070 CROMO ALARGO PARA LAVABO Y FREGADERO ALTO 70mm	
33,80 €		
A91070OC 91Z307127	A91070OC ORO CEPILLADO ALARGO PARA LAVABO Y FREGADERO ALTO 70mm	
59,10 €		
CEMP3201NM AAZ306325	CEMP3201 NEGRO MATE CAMISA CARTUCHO EMPOTRADO Ø32 PARA XX6801NM	
27,60 €		
CEMP3201OC AAZ306324	CEMP3201 ORO CEPILLADO CAMISA CARTUCHO EMPOTRADO Ø32 PARA XX6801OC	
32,20 €		
CEMP3504NM AAZ307193	CEMP3504NM NEGRO MATE CAMISA EMPOTRADO Ø35 DISTRIBUIDOR + LAVABO EMPO. PARA ANILLO	
51,30 €		
CEMP3505 AAZ307329	CEMP3505 CROMO CAMISA CARTUCHO THERMOSTATICO Ø35 DUCHA EMP. CON ANILLO	
29,40 €		
CEMP3505OC AAZ307332	CEMP3505OC ORO CEPILLADO CAMISA CARTUCHO THERMOSTATICO Ø35 DUCHA EMP. CON ANILLO	
51,30 €		

XX20CTNM AAZ302922	XX20CT NEGRO MATE LAVABO EMPO. PARA CAÑO TUBO S2 CON CAJA	
142,30 €	XX20CT BLACK MATTE CONCEALED WASHBASIN SPOUT TUBE WITH BOX S2	
XX20CTNC AAZ303103	XX20CT NIQUEL CEPILLADO LAV. EMP. PARA CAÑO TUBO S2 CON CAJA	
142,30 €	XX20CT BRUSHED NICKEL CONCEALED WASHBASIN SPOUT TUBO WITH BOX S2	
XX20CTOC AAZ303104	XX20CT ORO CEPILLADO LAV. EMP. PARA CAÑO TUBO S2 CON CAJA	
142,30 €	XX20CT BRUSHED GOLD CONCEALED WASHBASIN SPOUT TUBO WITH BOX S2	
XX2411 AAZ302560	XX2411 CROMO TERMOS. EMPOTRADO 1 VIA CON CAJA	
118,30 €	XX2411 CONCEALED THERMOSTATIC 1 WAY WITH BOX	
XX2411NM AAZ303109	XX2411 NEGRO MATE TERMO. EMP. 1 VIA CON CAJA	
215,10 €	XX2411 BLACK MATTE CONCEALED THERMOSTATIC 1 WAY WITH BOX	
XX8712NM AAZ303126	XX8712 NEGRO MATE EMP. TERMO. 2 VIAS CON CAJA	
215,10 €	XX8712 BLACK MATTE CONCEALED THERMOSTATIC 2 WAYS WITH BOX	
XX8712NC AAZ303124	XX8712 NIQUEL CEPILLADO EMP. TERMO. 2 VIAS CON CAJA	
215,10 €	XX8712 BRUSHED NICKEL CONCEALED THERMOSTATIC 2 WAYS WITH BOX	
XX8712OC AAZ303127	XX8712 ORO CEPILLADO EMP. TERMO. 2 VIAS CON CAJA	
215,10 €	XX8712 BRUSHED GOLD CONCEALED THERMOSTATIC 2 WAYS WITH BOX	
A91070NM 91Z307126	A91070NM NEGRO MATE ALARGO PARA LAVABO Y FREGADERO ALTO 70mm	
50,70 €		
CEMP3201 AAZ306323	CEMP3201 CROMO CAMISA CARTUCHO EMPOTRADO Ø32 PARA XX6801	
18,40 €		
CEMP3201NC AAZ306326	CEMP3201 NIQUEL CEPILLADO CAMISA CARTUCHO EMPOTRADO Ø32 PARA XX6801NC	
32,20 €		
CEMP3504 AAZ307192	CEMP3504 CROMO CAMISA EMPOTRADO Ø35 DISTRIBUIDOR + LAVABO EMPO. PARA ANILLO	
29,40 €		
CEMP3504OC AAZ307194	CEMP3504OC ORO CEPILLADO CAMISA EMPOTRADO Ø35 DISTRIBUIDOR + LAVABO EMPO. PARA ANILLO	
51,30 €		
CEMP3505NM AAZ307331	CEMP3505NM NEGRO MATE CAMISA CARTUCHO THERMOSTATICO Ø35 DUCHA EMP. CON ANILLO	
51,30 €		
CEMP3506 AAZ307333	CEMP3506 CROMO CAMISA MONTURA 3/4" Ø35 DUCHA EMP. CON ANILLO	
29,40 €		

CEMP3506NM AAZ307334	CEMP3506NM NEGRO MATE CAMISA MONTURA 3/4" Ø35 DUCHA EMP. CON ANILLO		CEMP3506OC AAZ307335	CEMP3506OC ORO CEPILLADO CAMISA MON- TURA 3/4" Ø35 DUCHA EMP. CON ANILLO	
51,30 €			51,30 €		
KA1XX6801 AAZ306846	KA1XX6801 CROMO KIT AMPLIACION WC MAG- NET PARA XX6801		KA1XX6801NC AAZ306849	KA1XX6801NC NIQUEL CEPILLADO KIT AMPLIA- CION WC MAGNET PARA XX6801NC	
13,20 €			17,70 €		
KA1XX6801NM AAZ306847	KA1XX6801NM NEGRO MATE KIT AMPLIACION WC MAGNET PARA XX6801NM		KA1XX6801OC AAZ306848	KA1XX6801OC ORO CEPILLADO KIT AMPLIACION WC MAGNET PARA XX6801OC	
17,40 €			17,90 €		

# Condiciones de venta General Sale Conditions





# Condiciones de venta

## 1. Generalidades

La aceptación de un pedido implica por parte del comprador la aceptación de las presentes condiciones generales de venta, salvo acuerdo particular entre ambos mediante estipulaciones precisas incluidas en el texto de aceptación del pedido. Nuestros modelos reflejados en esta Tarifa, podrán ser modificados o eliminados sin previo aviso y sin incurrir en ninguna responsabilidad o indemnización, así como sus precios.

## 2. Precios

Los precios de esta Tarifa se entienden sin impuestos y considerando la mercancía puesta en nuestros almacenes. Los impuestos en vigor se establecerán en cada factura. Los pedidos cuyo importe neto sea superior a 150 € se enviarán a portes pagados dentro del territorio de España (excepto Canarias, Ceuta y Melilla, donde el importe deberá ser superior a 300 €). Los P.V.P. son precios recomendados.

## 3. Expediciones

Nuestros productos se consideran siempre vendidos en nuestros almacenes y la fecha de expedición es la que figura en nuestra factura. Las mercancías se expiden y viajan únicamente a riesgo (y cuenta) del destinatario, aunque sean enviadas a portes pagados. El destinatario comprobará al recibo de la mercancía el estado de la misma, indicando las posibles anomalías en el albarán del transportista. Declinamos toda responsabilidad en relación con averías o pérdidas de la mercancía por causas del transporte, así como retrasos que puedan producirse por causa del mismo. En caso de error u omisión en una entrega por nuestra parte, nuestra responsabilidad alcanza a reemplazar la pieza no conforme o la entrega de la no remitida.

## 4. Plazos de entrega

Los pedidos que se reciban sin indicación de fecha de entrega, se servirán en el plazo más breve de tiempo, de acuerdo con nuestras posibilidades de entrega y pudiéndolo hacer en varias expediciones. Los plazos de entrega o de expedición son dados a título orientativo. Por lo tanto, un retraso cualquiera o una expedición fraccionada no será motivo de indemnización o reclamación alguna.

## 5. Condiciones de pago

Las facturas serán pagadas en un plazo máximo de 60 días fecha factura.

## 6. Devoluciones

### 6.1. Devoluciones comerciales



No se admitirá ninguna devolución de material que no haya sido pactada expresamente con fábrica o con nuestro representante y autorizada por nuestra DIRECCIÓN COMERCIAL. Para cualquier devolución se definirán exactamente los motivos de la misma, teniendo en cuenta las siguientes premisas:

- No se admitirá ningún material que, tanto en modelo como en acabado, esté fuera del catálogo y/o de garantía
- No se admitirá material deteriorado, que presente evidencias de haber sido manipulado y/o instalado, o que no se devuelva en su embalaje original.
- El material que se encuentre en perfecto estado, tras ser revisado por personal técnico de fábrica, será abonado según la tarifa vigente en el momento de la compra con un demérito del 20% por gastos de gestión.
- No se aceptará ninguna devolución que no se ajuste a todo lo especificado.

### 6.2. Devoluciones Calidad

No se admitirá ninguna devolución de material que no haya sido gestionada a través del formulario de incidencias correspondiente y autorizada previamente por nuestro DEPARTAMENTO DE CALIDAD. Cualquier devolución por motivos de calidad debe ajustarse a las condiciones de garantía expuestas en el apartado 8 de estas condiciones generales.

## 7. Homologación y certificación AENOR

El Ministerio de Industria y Energía ha concedido la homologación de la mayoría de productos contenidos en esta Tarifa y AENOR  ha certificado el derecho de uso de la marca  por considerar que cumplen las condiciones del reglamento aprobado por Real Decreto 2584/81. Así como las características exigidas en las normas UNE-EN 817 para monomandos y UNE-EN 200 para bimandos.

Los productos que han obtenido esta homologación y disponen del Certificado de derecho de uso de la marca AENOR están identificados en la lista de precios y en las piezas con el símbolo.

## 8. Condiciones generales de garantía Ramon Soler

Ramon Soler garantiza su grifería durante 5 años ante eventuales defectos estructurales, de material o de fabricación.

Los cartuchos termostáticos, temporizados y mecanismos electrónicos tienen una garantía de 3 años.

Los accesorios (flexos, mandos de ducha, rociadores, soportes, columnas de ducha, etc...) tienen una garantía de 3 años.

Los materiales consumibles y aquellos que se desgastan por el uso ordinario (pilas, filtros, juntas, aireadores, etc...) no están cubiertos por esta garantía, excepto que se demuestren defectos de fabricación.

La fecha de adquisición debe justificarse mediante comprobante de compra.

Para que la garantía sea válida, es necesario en cada caso, la aceptación del defecto por departamento técnico de RAMON SOLER, quien determinará si realiza la reparación, reposición parcial o total de la pieza.

La eventual reparación o sustitución de componentes del producto afectado, no extiende la ampliación de la Garantía.

Quedan excluidos de la garantía:

- Los productos que la instalación y conexión no se haya realizada según las correspondientes instrucciones de uso o instalación.
- Los productos que la utilización, mantenimiento y limpieza no se haya realizado conforme a las indicaciones del fabricante.
- Los daños producidos por uso inadecuado, montaje defectuoso, desgaste natural o medios de mantenimiento inadecuados.
- Los daños debidos a condiciones externas como presión excesiva, condiciones ambientales extremas.
- Problemas funcionales derivados de la existencia de cuerpos extraños, como arena, restos de obra... o acumulación de cal.

En caso de que en el momento de la aplicación de garantía el producto ya no se fabrique, se suministrará un producto similar de igual calidad.

En el caso de conjuntos formados por diferentes componentes, si una de las piezas del mismo presenta un defecto de fabricación se procederá a la reparación o reposición de la pieza afectada, pero en ningún caso se sustituirá el conjunto en su totalidad.

Alcance territorial: La garantía de la grifería se aplicará en país de venta de la misma.

Vías de reclamación:

Las reclamaciones deberán dirigirse al distribuidor o proveedor del producto a fin de que éstos últimos gestionen la garantía con el fabricante.

En caso de no disponer medio de comunicación con el distribuidor/proveedor del producto o verse imposibilitado de localizarlo podrán ponerse en contacto con Industrias Ramón Soler, S.A. según la información de contacto detallada a continuación: incidencias@rsramonsoler.com

At. Cliente: + 34 93 373 80 01

## 9. Reserva de dominio

Los productos suministrados serán propiedad de esta SOCIEDAD Industrias Ramón Soler, S.A. hasta el pago completo de la factura correspondiente.

## 10. Jurisdicción

La disposición de INDUSTRIAS RAMON SOLER, S.A. para resolver por vía amistosa las posibles divergencias surgidas con nuestros clientes está basada en la buena fe que preside las mutuas relaciones comerciales. Ahora bien, en caso de litigio ambas partes se someterán a la jurisdicción de los Tribunales de Barcelona con renuncia expresa a cualquier otro fuero.

# General Sale Conditions

## 1. General

Acceptance of an order implies that the purchase accepts these general sales conditions except in the case of separate agreement between the parties embodied in precise stipulations stated in the accepting the order. The models described in this price list may be modified or removed from sale without prior notice without incurring in any liability or responsibility for damages. Prices may also be modified without prior notice.

## 2. Prices

The prices on this price list are before tax and ex warehouse. Applicable taxes will be established for each invoice. The retail sales prices given are our recommended prices.

## 3. Dispatch

Our products are always considered sold at our warehouses and the date of dispatch as stated on our invoice. Goods are dispatched exclusively at the risk and at the cost of the consignee. On reception of the goods, the consignee should check their state, reporting any anomalies on the transport delivery note. We decline all responsibility for breakage or loss of goods in transports, and for any delays in transport. In case of error or omission in a dispatch, our responsibility extends solely and exclusively to replacing the defective part or parts or the delivery of goods not dispatched.

## 4. Delivery times

Orders received which do not state delivery date will be satisfied in the shortest possible period of time in accordance with our possibilities, and may be dispatched in more than one consignment. Delivery times given are for guidance only, and no liability will be incurred by any delays or partial deliveries.

## 5. Conditions of payment

Failure to comply with previously agreed conditions of payment on the part of purchasers may lead to retention or cancellation of orders pending until the entire debt is paid. The purchasers will be liable to pay the expenses incurred by any delay in payment beyond the dates established, even if by mutual agreement.

## 6. Returns

### 6.1. Stock returns

Stock returns will not be admitted by the factory unless they have been accorded directly with our agent and authorised by the Sales Manager. For each of these returns a specific reason shall be given, taking into account the following:

- No returns will be accepted of obsolete material or goods out of warranty.
- No deteriorated material shall be accepted, which has been manipulated or installed, and which doesn't have the original packaging.
- The returned goods (after being checked by factory personnel) will be credited using a depreciation of 20% on the current list price minus the corresponding discount.
- No other types of returns shall be accepted which do not comply with the aforementioned points.

### 6.2. Quality control returns

No returns will be undertaken which have not been duly processed with the correct "incidents" form and authorised by the quality department. Any returns done due to quality issues will be in the warranty conditions expressed in chapter 8 of the general sales conditions.

## 7. Approval and AENOR certification

The Spanish Ministry of Industry and Energy has officially approved most of the products in this price list and AENOR has certified the right to use the trademark as they comply with the conditions approved by Royal Decree 2584/81 and the conditions required by the standards UNE-EN 817 for mechanical mixing valves and UNE-EN 200 for single and mixer taps. Products thus approved and certified for the use of the AENOR trademark are identified in catalogues and on the parts themselves by the symbol.

## 8. Five-years guarantee

Ramon Soler guarantees its tapware during 5 YEARS against structural or material or manufacturing defects.

Thermostatic cartridges, self-closing cartridges and electronic components have a guarantee of 3 years.

Accessories (flexible hose, handshowers, headshowers, wall supports, shower columns, etc...) have a guarantee of 3 years.

Consumable materials and those which wear out from ordinary use (batteries filters, aerators, seals) are not covered by this guarantee, except if they have manufacturing defects.

Date of purchase must be shown via invoice or receipt.

In order to the warranty claim to be covered, in each case the defect must be revised and accepted by Ramon Soler After Sales Dept., who will determine whether repair the product, partially replace a component of the product or replace the product completely.

The eventual repair or substitution of the components does not prolong the guarantee.

Guarantee of the products does not apply if:

- The installation and connection to the system has been not undertaken according to the installation manual or use instructions.
- The use, maintenance and cleaning has been not undertaken in conformity with Ramon Soler instructions.
- The damage produced by an inadequate use, defect installation, natural wear out or incorrect maintenance
- The damage produced by external conditions like too high pressure or extreme environmental conditions.
- Functional problems due the impurities of the water as sand, construction waste or limestone accumulation.

If the product claimed in guarantee has been discontinued in our product line, it will be substituted by one of similar characteristics.

In the case of products set formed by different products, if a product part presents a defect, it will be repaired or changed such product part and not the rest of the components set.

The guaranteed product will be applied in the country where the product has been sold.

The claim of the guarantee must be done through the retailer or distributor where the product has been sold. In case of not knowing where to claim, the claims must be addressed to Industrias Ramon Soler S.A.:

incidencias@rsramonsoler.com or +34 93 373 80 01

## 9. Reservation of ownership

Products supplied will remain the pro-perty of RS until complete payment of the corresponding invoice has been made.

## 10. Jurisdiction

In the interest of conserving good commercial relations, INDUSTRIAS RAMÓN SOLER, S.A, desires to resolve any differences with our customers through amicable agreement. Nevertheless, in the case of litigation, both parties submit themselves to the jurisdiction of the courts and tribunals of Barcelona, expressly renouncing any other jurisdiction.

Dirección / Adress:

Industrias Ramon Soler, S.A.  
Vallespir, 26. Pol. Ind. Font Santa  
08970 Sant Joan Despí (Barcelona). Spain

Tel. +34 933 738 001  
Fax. +34 933 737 858  
email: [info@rsramonsoler.com](mailto:info@rsramonsoler.com)  
[www.ramonsoler.net](http://www.ramonsoler.net)

Diseño Design:

Dpt. Marketing Industrias Ramon Soler  
Noviembre 2022

Agradecimientos Acknowledgements:

Agencia Agency: VXLAB Design Management SL  
Fotografía Photography: Stella Rotger  
Imprenta Printer: Ingoprint





