



hidráulica alsina, s.a.

TARIFA

Mayo 2026

Síguenos en las redes sociales:



www.bombashasa.com

CONDICIONES GENERALES DE VENTA

ES PRECIOS

Los precios son de venta al público, siendo por cuenta del comprador los impuestos vigentes en el momento de la compra.

PORTES

- 1) Siempre son a cuenta y riesgo del comprador.
- 2) Cuando el porte sea pagado, viajará por el transporte elegido por hidráulica alsina, s.a., cualquier otro que se indique, será a cargo del comprador. En caso de reclamación el comprador debe hacer constar el motivo de la misma en el albarán de entrega que deberá firmar al transportista y remitir una copia del mismo a hidráulica alsina, s.a.. Si no se comunica la incidencia en un plazo de 24 h., posterior a la recepción, no podemos cursar ninguna reclamación a la compañía de transporte.
- 3) En caso de no llegar al importe mínimo de pedido la mercancía podrá viajar a portes pagados cargando 15€ en factura. Excepto exportación.

PAGO

Se acordará con el departamento comercial según las condiciones establecidas por hidráulica alsina, s.a. y acorde con la Ley 15/2010 que regula los plazos máximos de pago. La propiedad del material suministrado será de hidráulica alsina, s.a. hasta la cancelación de la factura.

DEVOLUCIONES

- 1) Ninguna devolución será aceptada sin la previa autorización de nuestro departamento técnico-comercial.
- 2) Las devoluciones serán siempre a portes pagados.
- 3) No se efectuarán abonos de materiales que no estén en condiciones de venta o que les falte el embalaje.
- 4) El abono de dicho material se realizará con una reducción, gastos a parte, del 10% sobre el precio que hubiese sido facturado.

GARANTÍA

- Todas nuestras electrobombas tienen una garantía de tres años a partir de la fecha de venta, sobre cualquier defecto de fabricación, quedando limitada al reemplazamiento de las piezas defectuosas por personal técnico de hidráulica alsina, s.a. sin indemnización alguna.
- El exámen de las averías y sus causas serán siempre exclusiva del personal autorizado de hidráulica alsina, s.a.
- La intervención o manipulación en la bomba de cualquier persona ajena al servicio oficial anulará la garantía.
- El envío de los materiales defectuosos a los servicios oficiales de reparación, o a nuestros propios talleres, será por cuenta y riesgo del comprador.
- A efectos de garantía, no se considerarán cubiertas las averías producidas por:
 - Los desgastes normales producidos en componentes que puedan sufrir desgaste mecánico por funcionamiento.
 - Los que hayan sido motivados por almacenamiento, uso o conservación inadecuados.
 - Los que hayan sido originados por una instalación defectuosa por parte del comprador.
 - Las averías de motor que no aparezcan en su puesta en marcha, ya que se entiende que cualquier avería posterior será debida a una falta de protección eléctrica adecuada o a un problema en el suministro de la red eléctrica de alimentación.

GENERALIDADES

- A fin de mejorar la calidad de nuestros productos, hidráulica alsina, s.a., se reserva el derecho a modificar en cualquier momento y sin previo aviso, las características de nuestros fabricados sin obligación alguna de notificarlo al comprador.
- Las ilustraciones y grabados de nuestros folletos y catálogos no tienen otro carácter que el orientativo, y no podrán en ningún caso, considerarse como contractuales.
- hidráulica alsina, s.a., no se responsabiliza de posibles errores contenidos en este catálogo general, debidos a la impresión del mismo. Así mismo se reserva el derecho de realizar las modificaciones oportunas sin perjuicio de las características básicas de nuestros productos.
- Se prohíbe la reproducción total o parcial, por cualquier medio, de la información contenida en este catálogo general.

JURISDICCIÓN

En caso de discrepancias o litigios por incumplimiento de las condiciones pactadas, comprador y vendedor se someten a los Juzgados y Tribunales del domicilio del vendedor, con renuncia expresa a que pudiera corresponderles.

EN PRICES

The prices are retail prices, current taxes will be borne by the buyer at the moment of purchasing

CARRIAGE

- 1) Always at the expense and risk of the purchaser.
- 2) In case of carriage paid, Hidráulica Alsina, S.A. will choose the shipping company, any other shipping company will be at the purchaser's expense. In case of claims, the purchaser should indicate the reason for such claim on the delivery note to be signed and handed to the carrier and send a copy to Hidráulica Alsina, S.A. If incidents are not reported within 24 hours after the reception, no claims to the shipping company can be filed.
- 3) In case of not reaching the minimum order amount, the goods will be shipped freight prepaid, charging € 15 on the invoice. Except for export.

PAYMENT

To be agreed with the commercial department according to conditions established by Hidráulica Alsina, S.A. and in accordance with the Law 15/2010 stating the maximum period of payment. Hidráulica Alsina, S.A. will be the owner of the material supplied until the invoice is fully paid.

RETURNS

- 1) Returns will not be accepted without prior approval from our technical-commercial department.
- 2) Returns will always be at carriage paid conditions.
- 3) Refunds will not be accepted for materials that are not in good conditions for being sold or without their original packaging.
- 4) Refunds will be made with a reduction of a 10%, expenses not included, over the amount that should have been invoiced.

WARRANTY

- All our electro-pumps are covered by three-year warranty from the date of sale, for any manufacture defects, the replacement of defective parts will be exclusively carried out by the technical staff of Hidráulica Alsina, S.A. without compensation of any sort.
- Inspection of breakdowns and their causes will always be carried out by the authorized staff of Hidráulica Alsina, S.A.
- Intervention or handling the pump by any person other than the approved official service will void the warranty.
- The shipping of defective materials to the approved official services or to our repair shops will be at the expense and risk of the purchaser.
- For warranty purposes, the following failure will not be covered:
 - Normal wear produced on components that may suffer mechanical wear by operation.
 - Those that have been motivated by inadequate storage, use or conservation.
 - Those that have been originated by a defective installation on the part of the buyer.
 - The motor failure that do not appear in its start-up, since it is understood that any subsequent failure will be due to a lack of adequate electrical protection or a problem in the supply of the power supply network.

GENERAL ASPECTS

- In order to improve the quality of our products, Hidráulica Alsina, S.A. reserves the right to modify, at any moment and without prior notice, the characteristics of our manufactured products without the obligation to notify the purchaser.
- Pictures and drawings in our brochures and catalogs are only illustrative and will never be considered as contractual.
- Hidráulica Alsina, S.A. is not liable for possible errors made in this general catalog due to printing. Likewise, it reserves the right to make the appropriate modifications without prejudice of the basic characteristics of our products.
- Total or partial copy, by any means, of the information contained in this general catalog is forbidden.

JURISDICTION

In case of discrepancies or litigations due to unfulfillment of the agreed conditions, the purchaser and the seller undertake to appear before the Courts and Tribunals of the seller's address, with an express waiver of any other jurisdiction.

FR PRIX

Les prix sont pour la vente au public, les taxes en vigueur au moment de l'achat étant à la charge de l'acheteur.

FRAIS DE PORTS

- 1) Ils sont toujours pour le compte de l'acheteur.
- 2) Lorsque les frais de port est payé, la marchandise voyagera par le transporteur choisi par hidráulica alsina, s.a. Tout autre indique sera à la charge de l'acheteur. En cas de réclamation, l'acheteur doit en indiquer le motif sur le bordereau de livraison qui doit être signé et donné au transporteur et envoyer une copie à hidráulica alsina, s.a. Si l'incident n'est pas communiqué dans les 24 heures après la réception, nous ne pouvons faire aucune réclamation auprès de la compagnie de transport.
- 3) En cas de non-atteinte du montant minimum de commande, la marchandise sera envoyée port payé, en facturant 15 € sur la facture. Sauf exportation.

PAIEMENT

Il sera convenu avec le département commercial selon les conditions établies par hidráulica alsina, s.a. et conformément à la Loi 15/2010 qui réglemente les délais de paiement maximums. Le propriétaire du matériel fourni sera hidráulica alsina, s.a. jusqu'au paiement de la facture.

RETOURS

- 1) Aucun retour ne sera accepté sans l'autorisation préalable de notre service technique-commercial.
- 2) Les retours devront toujours avoir les frais de ports payés.
- 3) Il n'y aura pas de remboursement des produits qui ne soient pas en conditions de vente ou sans l'emballage d'origine.
- 4) Le paiement dudit matériel sera effectué avec une réduction, frais à part, du 10% sur le prix qui aurait été facturé.

GARANTIE

- Toutes nos pompes électriques ont une garantie de trois ans à partir de la date de vente, sur tout défaut de fabrication, se limitant au remplacement des pièces defectueuses par le personnel technique d'hydraulica alsina, s.a. sans compensation.
- L'examen des pannes et de leurs causes sera toujours exclusif du personnel autorisé d'hydraulica alsina, s.a.
- L'intervention ou la manipulation de la pompe de toute personne en dehors du service officiel annulera la garantie.
- L'envoi des matériaux defectueux aux services de réparation officiels, ou à nos propres ateliers, sera aux risques de l'acheteur.
- On ne considérera pas couvertes par la garantie les pannes produites par:
 - Usure normale produite sur des composants susceptibles de subir une usure mécanique à cause du fonctionnement.
 - Celles qui ont été motivées par un stockage, une utilisation ou une conservation dans des conditions inadéquates.
 - Celles qui ont été causées par une installation defectueuse de la part de l'acheteur.
 - Les pannes du moteur qui n'apparaissent pas lors de sa mise en service, car il s'en déduit que toute panne ultérieure sera due à un manque de protection électrique adéquate ou à un problème d'alimentation du réseau d'alimentation.

GÉNÉRALITÉS

- Afin d'améliorer la qualité de nos produits, hidráulica alsina, s.a., se réserve le droit de modifier à tout moment et sans préavis, les caractéristiques de nos produits sans obligation d'en informer l'acheteur.
- Les illustrations et gravures de nos brochures et catalogues ont un caractère uniquement indicatif, et ne peuvent en aucun cas être considérées comme contractuelles.
- hidráulica alsina, s.a. n'est pas responsable des erreurs possibles contenues dans ce catalogue général, en raison de l'impression de celui-ci. Il se réserve également le droit d'apporter les modifications nécessaires sans préjudice des caractéristiques de base de nos produits.
- La reproduction totale ou partielle, par quelque moyen que ce soit, des informations contenues dans ce catalogue général est interdite.

JURISDICTION

En cas de divergences ou de litiges pour violation des conditions convenues, l'acheteur et le vendeur soumettent aux Tribunaux de l'adresse du vendeur, renonçant expressément à tout autre qui pourrait correspondre.

TARIFA DE PRECIOS MAYO 2026

Electrobombas centrífugas monobloc horizontal Serie Niza

9	Pág Catálogo	Código	Modelo	C.V.	P.V.P. Euros
		7584	NIZA 4.2 M	0,35	260,00
		7586	NIZA 4.3 M	0,5	295,00
		7588	NIZA 4.4 M	0,75	331,00
		7602	NIZA 4.5 M	1	385,00
		7603	NIZA 4.5 T	1	385,00
		7604	NIZA 6.3 M	0,8	358,00
		7605	NIZA 6.3 T	0,8	358,00
		7590	NIZA 6.4 M	1	393,00
		7591	NIZA 6.4 T	1	393,00
		7592	NIZA 6.5 M	1,3	427,00
		7593	NIZA 6.5 T	1,3	427,00
		7606	NIZA 6.6 M	1,5	486,00
		7607	NIZA 6.6 T	1,5	486,00
		7594	NIZA 10.3 M	1	486,00
		7595	NIZA 10.3 T	1	486,00
		7596	NIZA 10.4 M	1,5	549,00
		7597	NIZA 10.4 T	1,5	549,00
		7598	NIZA 10.5 M	2	607,00
		7599	NIZA 10.5 T	2	607,00
		7600	NIZA 10.6 T	3	679,00

Electrobombas centrífugas monobloc horizontal Serie HMI Inox 304

10	Pág Catálogo	Código	Modelo	C.V.	P.V.P. Euros
		1520	HMI 2/40 M	0,75	494,00
		1521	HMI 2/50 M	0,75	513,00
		1522	HMI 2/60 M	1	556,00
		1523	HMI 2/60 T	1	533,00
		1665	HMI 4/30 M	1	592,00
		1666	HMI 4/30 T	1	592,00
		1667	HMI 4/40 M	1	668,00
		1668	HMI 4/40 T	1	668,00
		1669	HMI 4/50 M	1,35	746,00
		1670	HMI 4/50 T	1,35	746,00
		1671	HMI 4/60 M	1,5	961,00
		1672	HMI 4/60 T	1,5	961,00
		1673	HMI 4/70 M	2	1.348,00
		1674	HMI 4/70 T	2	1.415,00

Electrobombas centrifugas multicelulares en acero inoxidable AISI 304 Serie HM-S

11	Pág Catálogo	Código	Modelo	C.V.	P.V.P. Euros
		7100	3HM04S T	0,4	1.001,00
		7101	3HM04S M	0,7	1.122,00
		7102	3HM05S T	0,55	1.032,00
		7103	3HM05S M	0,7	1.232,00
		7104	3HM06S T	0,7	1.220,00
		7105	3HM06S M	0,7	1.364,00
		7106	3HM07S T	1	1.591,00
		7107	3HM07S M	0,75	1.653,00
		7108	3HM09S T	1,5	1.731,00
		7109	3HM09S M	1	2.006,00
		7110	5HM04S T	0,7	1.082,00
		7111	5HM04S M	0,7	1.342,00
		7112	5HM05S T	1	1.352,00
		7113	5HM05S M	1	1.495,00
		7114	5HM06S T	1,5	1.631,00
		7115	5HM06S M	1	1.736,00
		7122	5HM08S T	1,5	1.801,00
		7123	5HM08S M	1,3	1.901,00
		7124	5HM09S T	2	1.963,00
		7125	5HM09S M	1,5	2.102,00
		7130	10HM03S T	1,5	1.662,00
		7131	10HM03S M	1,5	2.123,00
		7132	10HM04S T	2	1.942,00
		7133	10HM04S M	2	3.043,00
		7134	10HM05S T	3	2.503,00
		7145	10HM05S M	3	2.842,00
		7146	10HM06S T	3	2.763,00
		7147	10HM06S M	3	2.983,00

Electrobombas centrifugas multicelulares en acero inoxidable AISI 316 L Serie HM-N

11	Pág Catálogo	Código	Modelo	C.V.	P.V.P. Euros
		7900	3HM04N T	0,4	1.201,00
		7901	3HM04N M	0,7	1.342,00
		7902	3HM05N T	0,55	1.251,00
		7903	3HM05N M	0,7	1.454,00
		7904	3HM06N T	0,7	1.471,00
		7905	3HM06N M	0,7	1.614,00
		7906	3HM07N T	1	1.901,00
		7907	3HM07N M	0,75	1.963,00
		7908	3HM09N T	1,5	2.083,00
		7909	3HM09N M	1	2.395,00

Electrobombas centrífugas multicelulares en acero inoxidable AISI 316 L Serie HM-N

11	Continuación	Código	Modelo	C.V.	P.V.P. Euros	
		7910	5HM04N T	0,7	1.292,00	
		7911	5HM04N M	0,7	1.593,00	
		7912	5HM05N T	1	1.612,00	
		7913	5HM05N M	1	1.777,00	
		7914	5HM06N T	1,5	1.942,00	
		7915	5HM06N M	1	2.066,00	
		7916	5HM08N T	1,5	2.161,00	
		7917	5HM08N M	1,3	2.262,00	
		7918	5HM09N T	2	2.362,00	
		7919	5HM09N M	1,5	2.503,00	
		7920	10HM03N T		1,5	2.001,00
		7921	10HM03N M		1,5	2.522,00
		7922	10HM04N T		2	2.321,00
		7923	10HM04N M		2	3.484,00
		7924	10HM05N T		3	2.983,00
		7925	10HM05N M		3	3.403,00
		7926	10HM06N T		3	3.324,00
	7927	10HM06N M		3	3.585,00	

Electrobombas centrífugas sanitarias en 'AISI 316L' Serie ECO-MAT

12	Pág. Catálogo	Código	Modelo	P.V.P. Euros.
		SERIE ECO-MAT		Consultar

Electrobombas centrífugas sanitarias en 'AISI 316L' Serie MATINOX

13	Pág. Catálogo	Código	Modelo	P.V.P. Euros.
		SERIE MATINOX		Consultar

Electrobombas centrífugas monobloc horizontal Serie Monoturbina

14	Pág Catálogo	Código	Modelo	C.V.	P.V.P. Euros
		1822	HT-75	0,75	389,00
		1823	HM-75	0,75	389,00
		1824	HT-95	1	410,00
		1825	HM-95	1	410,00
		1826	HT-145	1,5	686,00
		1827	HM-145	1,5	686,00
		1828	HT-195	2	720,00
		1829	HM-195	2	779,00
		1957	HT-295	3	761,00
		1958	HT-395	4	1.252,00
		1959	HT-495	5,5	1.304,00

Electrobombas centrífugas monobloc horizontal Serie Biturbina (Latón)

15	Pág Catálogo	Código	Modelo	C.V.	P.V.P. Euros
		1010	HT-80	0,8	520,00
		1011	HM-80	0,8	520,00
		1012	HT-100	1	541,00
		1013	HM-100	1	541,00
		1014	HT-150	1,5	764,00
		1015	HM-150	1,5	764,00
		1016	HT-200	2	803,00
		1009	HM-200	2	881,00
		1017	HT-300	3	957,00
		1018	HT-400	4	1.442,00
		1019	HT-550	5,5	1.598,00
		1412	HT-750	7,5	2.320,00
		1413	HT-1000	10	3.395,00
		1414	HT-1300	12,5	3.738,00
		1415	HT-1500	15	3.836,00

Electrobombas centrífugas monobloc horizontal Serie Biturbina (Plástico)

16	Pág Catálogo	Código	Modelo	C.V.	P.V.P. Euros
		1399	HM-155	1,5	666,00
		1398	HT-155	1,5	647,00
		1662	HM-165	2	685,00
		1663	HT-165	2	660,00
		1664	HT-175	3	722,00

Electrobombas centrífugas monobloc horizontal Serie Gran caudal

17	Pág Catálogo	Código	Modelo	C.V.	P.V.P. Euros
		1051	RGT-8	0,8	416,00
		1052	RGM-8	0,8	416,00
		1053	RGT-10	1	427,00
		1054	RGM-10	1	427,00
		1677	RGT-15	1,5	783,00
		1678	RGM-15	1,5	811,00
		1679	RGT-20	2	801,00
		1680	RGM-20	2	844,00
		1049	RGT-S-17/2	1,5	710,00
		1050	RGM-S-17/2	1,5	710,00
		1064	RGT-S-20/2	2	728,00
		1039	RGM-S-20/2	2	728,00

Electrobombas centrífugas monobloc horizontal Serie HCI Inox 304

18	Pág Catálogo	Código	Modelo	C.V.	P.V.P. Euros
		1089	HCI-50 M	0,5	252,00
		1090	HCI-100 T	1	467,00
		1091	HCI-100 M	1	467,00
		1092	HCI-120 T	1,2	508,00
		1093	HCI-120 M	1,2	508,00
		1094	HCI-150 T	1,5	613,00
		1095	HCI-150 M	1,5	613,00
		1096	HCI-200 T	2	654,00
		1097	HCI-200 M	2	654,00
		1098	HCI-300 T	3	824,00
	1099	HCI-400 T	4	883,00	

Electrobombas centrífugas monobloc horizontal Serie CO Inox 316L

19	Pág Catálogo	Código	Modelo	C.V.	P.V.P. Euros
		7150	CO-350/03 T	0,5	1.488,00
		7151	CO-350/03 M	0,5	1.488,00
		7152	CO-350/05 T	0,75	1.643,00
		7153	CO-350/05 M	0,75	1.643,00
		7154	CO-350/07 T	1	1.731,00
		7155	CO-350/07 M	1	1.731,00
		7156	CO-350/09 T	1,2	1.798,00
		7157	CO-350/09 M	1,2	1.798,00
		7158	CO-350/11 T	1,5	1.954,00
		7159	CO-350/11 M	1,5	1.954,00
		7160	CO-350/15 T	2	2.109,00
		7161	CO-350/15 M	2	2.109,00
		7162	CO-500/15 T	2	2.152,00
		7163	CO-500/15 M	2	2.152,00
		7164	CO-500/22 T	3	2.751,00
		7166	CO-500/30 T	4	2.930,00

Electrobombas centrífugas monobloc horizontal Serie MO Normalizada

20-21	Pág Catálogo	Código	Modelo	C.V.	P.V.P. Euros
		1430	MO32-160 B	3	1.576,00
		1431	MO32-160 A	4	1.703,00
		1432	MO32-200 C	5,5	2.002,00
		1433	MO32-200 B	7,5	2.103,00
		1434	MO32-200 A	10	2.267,00
		1435	MO32-250 C	12,5	3.714,00
		1436	MO32-250 B	15	3.906,00
		1437	MO32-250 A	20	5.394,00
		1438	MO40-160 B	4	1.479,00
		1439	MO40-160 A	5,5	1.532,00
		1440	MO40-200 B	7,5	2.150,00

Electrobombas centrífugas monobloc horizontal Serie MO Normalizada

20-21	Pág Catálogo	Código	Modelo	C.V.	P.V.P. Euros
		1441	MO40-200 A	10	2.290,00
		1442	MO40-250 B	15	3.019,00
		1443	MO40-250 A	20	4.254,00
		1444	MO50-125 B	4	1.449,00
		1445	MO50-125 A	5,5	1.513,00
		1446	MO50-160 B	7,5	2.118,00
		1447	MO50-160 A	10	2.283,00
		1448	MO50-200 C	12,5	2.616,00
		1449	MO50-200 B	15	2.992,00
		1450	MO50-200 A	20	4.172,00
		1451	MO50-250 C	20	5.415,00
		1452	MO50-250 B	25	4.542,00
		1453	MO50-250 A	30	4.770,00
		1454	MO65-125 B	7,5	2.114,00
		1455	MO65-125 A	10	2.282,00
		1456	MO65-160 C	12,5	2.629,00
		1457	MO65-160 B	15	2.977,00
		1458	MO65-160 A	20	4.157,00
		1459	MO65-200 C	20	5.416,00
		1460	MO65-200 B	25	4.546,00
		1461	MO65-200 A	30	4.800,00
		1462	MO65-250 B	40	11.426,00
		1463	MO65-250 A	50	12.393,00
		1464	MO80-160 D	15	3.146,00
		1465	MO80-160 C	20	4.429,00
		1466	MO80-160 B	25	4.594,00
		1467	MO80-160 A	30	4.967,00
		1468	MO80-200 B	40	11.435,00
		1469	MO80-200 A	50	12.408,00

Electrobombas centrífugas monobloc horizontal Serie MXO Normalizada Inox.

22-23	Pág Catálogo	Código	Modelo	C.V.	P.V.P. Euros
			MXO32-160/1,5	2	1.768,00
			MXO32-160/2,2	3	1.823,00
			MXO32-200/3	4	2.287,00
			MXO32-200/4	5,5	2.667,00
			MXO32-200/5,5	7,5	3.297,00
			MXO40-125/2,2	3	1.806,00
			MXO40-125/3	4	2.096,00
			MXO40-160/4	5,5	2.360,00
			MXO40-200/5,5	7,5	3.192,00
			MXO40-200/7,5	10	3.297,00
			MXO40-200/11	15	4.704,00

Electrobombas centrífugas monobloc horizontal Serie MXO Normalizada Inox.

22-23	Pág. Catálogo	Código	Modelo	C.V.	P.V.P. Euros
			MXO50-125/4	5,5	2.562,00
			MXO50-200/7,5	10	3.412,00
			MXO50-200/11	15	4.716,00
			MXO50-200/15	20	5.082,00
			MXO50-200/18,5	25	5.208,00
			MXO65-125/7,5	10	3.843,00
			MXO65-160/11	15	5.103,00
			MXO65-160/15	20	5.397,00
			MXO65-200/18,5	25	5.817,00
			MXO80-160/11	15	5.418,00
			MXO80-160/15	20	5.880,00
			MXO80-160/18,5	25	6.258,00
		MXO80-200/22	30	7.854,00	

Electrobombas centrífugas ejecución sobre bancada Serie Normalizada

24-25	Pág. Catálogo	Código	Modelo	P.V.P. Euros.
			SERIE SB/SB4 (32-40-50-65-80-100-125-150)	Consultar

Electrobombas centrífugas monobloc horizontal Serie Tritón

26	Pág. Catálogo	Código	Modelo	C.V.	P.V.P. Euros
		1370	HT-50/103	4	2.524,00
		1373	HT-60/103	4	2.524,00
		1376	HT-75/103	5,5	3.139,00
		1379	HT-90/103	5,5	3.139,00
		1382	HT-70/140	4	2.524,00
		1385	HT-85/140	5,5	3.139,00
		1388	HT-100/140	5,5	3.139,00

Electrobombas centrífugas monobloc horizontal Serie RGT Normalizada

27	Pág. Catálogo	Código	Modelo	C.V.	P.V.P. Euros
		1059	RGT-30	3	1.260,00
		1060	RGT-40	4	1.637,00
		1062	RGT-55	5,5	1.795,00

Electrobombas centrífugas para proceso químico Serie HSQ

28	Pág. Catálogo	Código	Modelo	P.V.P. Euros.
			SERIE HSQ	Consultar

Electrobombas centrífugas para fluido térmico Serie HFT

29	Pág. Catálogo	Código	Modelo	C.V.	P.V.P. Euros.
			SERIE HFT		Consultar

Electrobombas centrífugas autoaspirantes Serie Jet

30	Pág Catálogo	Código	Modelo	C.V.	P.V.P. Euros
		1028	NP-1	0,8	400,00
		1029	NPM-1	0,8	184,00
		1037	NP-3	1	413,00
		1038	NPM-3	1	191,00
		1046	NP-8	1,5	754,00
		1047	NPM-8	1,5	754,00

Electrobombas centrífugas autoaspirantes Serie Mega

31	Pág Catálogo	Código	Modelo	C.V.	P.V.P. Euros
		1611	MEGA-80 M	0,8	480,00
		1612	MEGA-80 T	0,8	480,00
		1238	MEGA-100 M	1	500,00
		1239	MEGA-100 T	1	500,00
		1613	MEGA-120 M	1,2	548,00
		1614	MEGA-120 T	1,2	548,00

Electrobombas centrífugas autoaspirantes Serie Duojet 4^º

32	Pág Catálogo	Código	Modelo	C.V.	P.V.P. Euros
		1030	APT-75	0,8	447,00
		1031	APM-75	0,8	447,00
		1040	APT-100	1	477,00
		1041	APM-100	1	477,00
		1042	APT-150	1,5	783,00
		1043	APM-150	1,5	802,00

Electrobombas centrífugas autocebantes Serie A

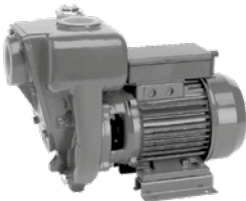
33	Pág Catálogo	Código	Modelo	C.V.	P.V.P. Euros
		1540	A-10 M	1,5	1.019,00
		1541	A-10 T	1,5	1.140,00
		1542	A-20 M	2	1.055,00
		1543	A-20 T	2	1.161,00
		1544	A-30 M	3	1.350,00
		1545	A-30 T	3	1.544,00
		1546	A-40 T	5,5	2.759,00
		1547	A-50 T	7,5	3.328,00

Electrobombas centrífugas periféricas Serie Fucsia

34	Pág Catálogo	Código	Modelo	C.V.	P.V.P. Euros
		1032	FT-50	0,5	521,00
		1033	FM-50	0,5	521,00
		1035	FT-8	1,2	752,00
		1036	FM-8	1,2	752,00

Electrobombas autoaspirantes para piscinas Serie Shark

35	Pág Catálogo	Código	Modelo	C.V.	P.V.P. Euros
		1122	SHARK 50 M	0,5	416,00
		1124	SHARK 75 M	0,75	428,00
		1126	SHARK 100 M	1	456,00
		1127	SHARK 100 T	1	456,00
		1128	SHARK 150 M	1,5	498,00
		1129	SHARK 150 T	1,5	498,00
		1130	SHARK 200 M	2	539,00
		1131	SHARK 200 T	2	539,00
		1132	SHARK 300 M	3	613,00
	1133	SHARK 300 T	3	574,00	

Electrobombas autoaspirantes para piscinas Serie Petunia-G

36	Pág Catálogo	Código	Modelo	C.V.	P.V.P. Euros
		1488	PTS-300 G	3	1.647,00
		1489	PTS-400 G	4	2.105,00
		1490	PTS-550 G	5,5	2.212,00
		1737	PT-400 G	4	3.058,00
		1738	PT-550 G	5,5	3.531,00
		1739	PT-750 G	7,5	4.561,00
		1740	PT-1000 G	10	4.816,00
		1741	PT-1250 G	12,5	6.362,00

Electrobombas centrífugas para piscinas Serie PTF Normalizada

37	Pág Catálogo	Código	Modelo	C.V.	P.V.P. Euros
		1730	PTF-30	3	2.640,00
		1731	PTF-40	4	2.842,00
		1732	PTF-55	5,5	2.880,00
		1733	PTF-75	7,5	3.529,00
		1734	PTF-100	10	3.688,00
		1735	PTF-150	15	4.511,00
		1736	PTF-200	20	5.732,00

Electrobombas centrífugas para piscinas Serie PTF Normalizada

37	Pág Catálogo	Código	Modelo	C.V.	P.V.P. Euros
		2634	PREFILTRO FUNDICION 2 1/2" (CESTILLO EN INOX)*		1.516,00
		2635	PREFILTRO FUNDICION 3" (CESTILLO EN INOX)*		1.548,00
		2637	PREFILTRO FUNDICION 3" (CESTILLO EN INOX)**		1.516,00
		2636	PREFILTRO FUNDICION 4" (CESTILLO EN INOX)**		1.516,00

Prefiltro Fundición: * 4 Agujeros, **8 Agujeros.

Electrobombas centrífugas monobloc horizontales Serie Manta

38	Pág Catálogo	Código	Modelo	C.V.	P.V.P. Euros
		1972	MANTA 100 T	1	810,00
		1974	MANTA 100 M	1	762,00

Electrobombas para natación contracorriente Serie Contra

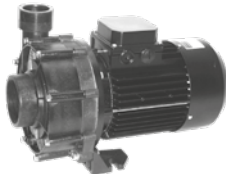
39	Pág Catálogo	Código	Modelo	C.V.	P.V.P. Euros
		1976	CONTRA 300 M	3	1.470,00
		1977	CONTRA 300 T	3	1.540,00
		1978	CONTRA 400 T	4	1.921,00
		1979	CONTRA 550 T	5,5	2.024,00
		2450	BOQUILLA CONTRACORRIENTE		220,00

Electrobombas sumergibles para sumideros Serie Play

40	Pág Catálogo	Código	Modelo	C.V.	P.V.P. Euros
		1216	PLAY-7000	0,8	389,00

Locales técnicos para piscinas Serie Casetas

41	Pág Catálogo	Código	Modelo	P.V.P. Euros
		3715	CASETA SEMI-ENTERRADA 500/75	Consultar
		3716	CASETA SEMI-ENTERRADA 600/100	Consultar
		3720	CASETA ENTERRADA 500/75	Consultar
		3721	CASETA ENTERRADA 600/100	Consultar

Accesorios para piscinas - Filtros

41	Pág Catálogo	Código	Modelo	P.V.P. Euros
		2420	FILTRO FV-450 CON VÁLVULA	900,00
		2421	FILTRO FV-500 CON VÁLVULA	970,00
		2422	FILTRO FV-600 CON VÁLVULA	1.118,00
		2423	FILTRO FV-650 CON VÁLVULA	1.211,00
		2424	FILTRO FV-750 CON VÁLVULA	1.573,00
		2425	FILTRO FV-900 CON VÁLVULA	2.162,00

Bombas dosificadoras electrónicas Serie Dosificadoras

42	Pág Catálogo	Código	Modelo	P.V.P. Euros
		1939	FC-07.01	394,00
		1938	FCO-07.03	455,00
		1940	FCO-05.05	455,00
		1941	TCO-05.15	1.542,00
		1942	VMS MF 07.06	1.115,00
		1943	VMS MS 05.10	1.230,00

Cloradores Salinos

43	Pág Catálogo	Código	Modelo	P.V.P. Euros
		2600	PLUMA CC10	2.109,00
		2601	PLUMA CC15	2.283,00
		2602	PLUMA CC20	2.599,00
		2651	PLUMA CC30	2.917,00
		2603	PLUMA CC10 + KIT RH ORO	2.594,00
		2604	PLUMA CC15 + KIT RH ORO	2.769,00
		2605	PLUMA CC20 + KIT RH ORO	3.084,00
		2652	PLUMA CC30 + KIT RH ORO	3.403,00
		2606	PLUMA CC10 + KIT RH ORO + KIT POOLUX PH	3.426,00
		2607	PLUMA CC15 + KIT RH ORO + KIT POOLUX PH	3.600,00
		2608	PLUMA CC20 + KIT RH ORO + KIT POOLUX PH	3.916,00
		2653	PLUMA CC30 + KIT RH ORO + KIT POOLUX PH	4.234,00

Electrobombas centrífugas multicelulares verticales Serie Roma 5-9 (Turbina Inox)

44	Pág Catálogo	Código	Modelo	C.V.	P.V.P. Euros
		1716	ROMA 5.4 T	1	381,00
		1717	ROMA 5.4 M	1	381,00
		1718	ROMA 5.5 T	1,3	424,00
		1719	ROMA 5.5 M	1,3	424,00
		1714	ROMA 5.6 T	1,5	465,00
		1715	ROMA 5.6 M	1,5	465,00

Electrobombas centrífugas multicelulares verticales Serie Roma 5-9 (Turbina Inox)

44	Continuación	Código	Modelo	C.V.	P.V.P. Euros
	7256	ROMA 9.3 T	1	479,00	
	7257	ROMA 9.3 M	1	479,00	
	7258	ROMA 9.4 T	1,5	530,00	
	7259	ROMA 9.4 M	1,5	530,00	
	7260	ROMA 9.5 T	2	583,00	
	7261	ROMA 9.5 M	2	583,00	
	7262	ROMA 9.6 T	3	721,00	
	7263	ROMA 9.7 T	3,5	772,00	
	7264	ROMA 9.8 T	4	787,00	

Electrobombas centrífugas multicelulares verticales Serie Roma 11-21 (Turbina Inox)

45	Pág Catálogo	Código	Modelo	C.V.	P.V.P. Euros
	1760	ROMA 11.4 T	1,5	714,00	
	1761	ROMA 11.4 M	1,5	753,00	
	1762	ROMA 11.5 T	2	785,00	
	1763	ROMA 11.5 M	2	830,00	
	1764	ROMA 11.6 T	3	865,00	
	1765	ROMA 11.8 T	4	1.207,00	
	1766	ROMA 11.10 T	5,5	1.325,00	
	1770	ROMA 21.4 T	3	865,00	
	1771	ROMA 21.6 T	4	1.263,00	
	1772	ROMA 21.7 T	5,5	1.382,00	

Electrobombas centrífugas multicelulares verticales Serie VS

46-47	Pág Catálogo	Código	Modelo	C.V.	P.V.P. Euros
	7460	VS 2 - 5	0,75	1.358,00	
	7461	VS 2 - 7	1	1.774,00	
	7462	VS 2 - 11	1,5	1.992,00	
	7463	VS 2 - 15	2	2.344,00	
	7464	VS 2 - 18	3	2.477,00	
	7465	VS 2 - 22	3	2.655,00	
	7280	VS 4 - 6	1,5	1.859,00	
	7282	VS 4 - 8	2	2.174,00	
	7466	VS 4 - 12	3	2.406,00	
	7467	VS 4 - 16	4	2.800,00	
	7468	VS 4 - 19	5,5	3.340,00	
	7285	VS 8 - 6	3	2.634,00	
	7286	VS 8 - 8	4	3.103,00	
	7287	VS 8 - 10	5,5	3.921,00	
	7469	VS 8 - 15	7,5	5.144,00	

Electrobombas centrífugas multicelulares verticales Serie VS

46-47	Pág Catálogo	Código	Modelo	C.V.	P.V.P. Euros
		7288	VS 16 - 4	5,5	3.485,00
		7290	VS 16 - 6	7,5	4.398,00
		7291	VS 16 - 7	10	4.464,00
		7470	VS 16 - 8	10	4.937,00
		7471	VS 16 - 12	15	6.503,00
		7477	VS 20 - 3	5,5	4.180,00
		7478	VS 20 - 5	7,5	5.144,00
		7479	VS 20 - 7	10	5.912,00
		7480	VS 20 - 10	15	6.736,00
		7481	VS 20 - 14	20	8.644,00
		7292	VS 32 - 3	7,5	5.767,00
		7293	VS 32 - 4	10	6.161,00
		7294	VS 32 - 5	15	6.928,00
		7295	VS 32 - 6	15	7.171,00
		7296	VS 32 - 8	20	8.540,00
		7472	VS 42 - 2	10	6.908,00
		7473	VS 42 - 3	15	8.635,00
		7474	VS 42 - 4	20	11.867,00
		7475	VS 42 - 5	25	13.648,00
		7476	VS 42 - 6	30	15.943,00
	7483	VS 65 - 2	15	8.393,00	
	7484	VS 65 - 3	25	12.522,00	
	7485	VS 65 - 4	30	15.195,00	
	7486	VS 65 - 5	40	16.064,00	

Electrobombas centrífugas multicelulares verticales In-line Serie VF/VX/VN

48-50	Continuación	Código	Modelo	C.V.	P.V.P. Euros
		SERIE VF/VX/VN			Consultar

Electrobombas sumergibles centrífugas multicelulares Serie Siena Inox.

51	Pág Catálogo	Código	Modelo	C.V.	P.V.P. Euros
		7930	SIENA 4.3 M	0,75	581,00
		7931	SIENA 4.5 M	1	674,00
		7932	SIENA 4.6 M	1,2	763,00
		7933	SIENA 4.8 M	1,5	832,00
		7934	SIENA 4.8 T	1,5	786,00
		7935	SIENA 7.4 M	1,2	665,00
		7936	SIENA 7.6 M	1,5	786,00
		7937	SIENA 7.6 T	1,5	721,00
		7938	SIENA 7.8 M	2	907,00
		7939	SIENA 7.8 T	2	828,00
		7940	SIENA 10.4 M	2	846,00
		7941	SIENA 10.4 T	2	772,00
	2364	ANODO DE SACRIFICIO PARA BOMBAS SIENA			55,00

Electrobombas sumergibles centrífugas multicelulares Serie Atenas

52	Pág Catálogo	Código	Modelo	C.V.	P.V.P. Euros	
		7078	ATENAS 103 M	0,7	473,00	
		7079	ATENAS 104 M	0,8	560,00	
		7080	ATENAS 105 M	1	627,00	
		7081	ATENAS 106 M	1,2	672,00	
		7082	ATENAS 107 M	1,6	744,00	
		7083	ATENAS 107 T	1,6	728,00	
		7088	ATENAS 205 T	3	1.083,00	
		2344	ÁNODO DE SACRIFICIO PARA BOMBAS ATENAS/PISA			74,00
		2648	BASE PARA ASPIRACIÓN FLOTANTE ATENAS			111,00

Electrobombas sumergibles centrífugas multicelulares Serie Atenas Plus

53	Pág Catálogo	Código	Modelo	C.V.	P.V.P. Euros	
		7095	ATENAS PLUS 104 M	0,8	775,00	
		7096	ATENAS PLUS 105 M	1	863,00	
		2344	ÁNODO DE SACRIFICIO PARA BOMBAS ATENAS/PISA			74,00
		2648	BASE PARA ASPIRACIÓN FLOTANTE ATENAS			111,00

Electrobombas sumergibles centrífugas multicelulares 4" Serie Pisa

54	Pág Catálogo	Código	Modelo	C.V.	P.V.P. Euros	
		1790	PISA 3/35 M	0,5	486,00	
		1791	PISA 3/55 M	0,75	552,00	
		1792	PISA 6/70 M	1	651,00	
		1793	PISA 6/70 T	1	651,00	
		1794	PISA 6/100 M	1,5	761,00	
		1795	PISA 6/100 T	1,5	761,00	
		2414	FILTRO ESP. ANTI-ARENA "PISA"			115,00
		2344	ÁNODO DE SACRIFICIO PARA BOMBAS ATENAS/PISA			74,00

Electrobombas sumergibles centrífugas multicelulares Serie Nenufar

55	Pág Catálogo	Código	Modelo	C.V.	P.V.P. Euros
		1150	NENUFAR-30 M	0,75	622,00
		1085	NENUFAR-40 M	1	797,00

Electrobombas sumergibles para fuentes decorativas Serie Fontana

56	Pág Catálogo	Código	Modelo	P.V.P. Euros
		1134	FONTANA-10	35,00
		1135	FONTANA-20	44,00
		1136	FONTANA-30	68,00
		1146	FONTANA-40	126,00
		1509	FONTANA-50	143,00
		2166	KIT SURTIDOR FONTANA-10/20	24,00
		2167	KIT SURTIDOR FONTANA-30/40/50	38,00

Electrobombas sumergibles centrífugas multicelulares Serie 4" (con motor baño aceite)

57	Pág Catálogo	Código	Modelo	C.V.	P.V.P. Euros
		7945	ST-2-11/S (III 230)	0,75	407,00
		7710	ST-2-11/S (III 400)	0,75	407,00
		7711	SM-2-11/S (II 230)	0,75	417,00
		7946	ST-2-14/S (III 230)	1	450,00
		7712	ST-2-14/S (III 400)	1	450,00
		7713	SM-2-14/S (II 230)	1	461,00
		7947	ST-2-19/S (III 230)	1,5	519,00
		7714	ST-2-19/S (III 400)	1,5	519,00
		7715	SM-2-19/S (II 230)	1,5	537,00
		7948	ST-2-25/S (III 230)	2	611,00
		7716	ST-2-25/S (III 400)	2	611,00
		7717	SM-2-25/S (II 230)	2	634,00
		7949	ST-2-35/S (III 230)	3	766,00
		7718	ST-2-35/S (III 400)	3	766,00
		7719	SM-2-35/S (II 230)	3	794,00
		7950	ST-4-8/S (III 230)	0,75	407,00
		7720	ST-4-8/S (III 400)	0,75	407,00
		7721	SM-4-8/S (II 230)	0,75	417,00
		7951	ST-4-10/S (III 230)	1	461,00
		7722	ST-4-10/S (III 400)	1	461,00
		7723	SM-4-10/S (II 230)	1	473,00
		7952	ST-4-14/S (III 230)	1,5	519,00
		7724	ST-4-14/S (III 400)	1,5	519,00
		7725	SM-4-14/S (II 230)	1,5	537,00
		7953	ST-4-19/S (III 230)	2	611,00
		7726	ST-4-19/S (III 400)	2	611,00
		7727	SM-4-19/S (II 230)	2	634,00
		7954	ST-4-26/S (III 230)	3	750,00
		7728	ST-4-26/S (III 400)	3	750,00
		7729	SM-4-26/S (II 230)	3	778,00
		7730	ST-4-34/S (III 400)	4	911,00
		7731	ST-4-44/S (III 400)	5,5	1.231,00

Electrobombas sumergibles centrífugas multicelulares Serie 4'' (con motor baño aceite)

57	Pág Catálogo	Código	Modelo	C.V.	P.V.P. Euros
		7955	ST-8-7/S (III 230)	1	428,00
		7732	ST-8-7/S (III 400)	1	428,00
		7733	SM-8-7/S (II 230)	1	440,00
		7956	ST-8-9/S (III 230)	1,5	482,00
		7734	ST-8-9/S (III 400)	1,5	482,00
		7735	SM-8-9/S (II 230)	1,5	498,00
		7957	ST-8-11/S (III 230)	2	547,00
		7736	ST-8-11/S (III 400)	2	547,00
		7737	SM-8-11/S (II 230)	2	569,00
		7958	ST-8-16/S (III 230)	3	675,00
		7738	ST-8-16/S (III 400)	3	675,00
		7739	SM-8-16/S (II 230)	3	703,00
		7740	ST-8-20/S (III 400)	4	831,00
		7741	ST-8-24/S (III 400)	5,5	1.104,00
		7742	ST-8-32/S (III 400)	7,5	1.756,00
		7959	ST-11-7/S (III 230)	2	698,00
		7755	ST-11-7/S (III 400)	2	698,00
		7756	SM-11-7/S (II 230)	2	723,00
		7960	ST-11-10/S (III 230)	3	865,00
		7757	ST-11-10/S (III 400)	3	865,00
		7758	SM-11-10/S (II 230)	3	895,00
		7759	ST-11-14/S (III 400)	4	1.094,00
		7770	ST-11-19/S (III 400)	5,5	1.494,00
		7771	ST-11-26/S (III 400)	7,5	2.334,00
		7961	ST-20-8/S (III 230)	3	860,00
		7750	ST-20-8/S (III 400)	3	860,00
		7751	SM-20-8/S (II 230)	3	892,00
		7752	ST-20-11/S (III 400)	4	1.113,00
		7753	ST-20-15/S (III 400)	5,5	1.488,00
		7754	ST-20-20/S (III 400)	7,5	2.267,00

Electrobombas sumergibles centrífugas multicelulares Serie 4'' (con motor Franklin)

57	Pág Catálogo	Código	Modelo	C.V.	P.V.P. Euros
		7800	ST-2-11/F (III 230)	0,75	953,00
		7801	ST-2-11/F (III 400)	0,75	881,00
		7802	SM-2-11/F (II 230)	0,75	900,00
		7803	ST-2-14/F (III 230)	1	1.026,00
		7804	ST-2-14/F (III 400)	1	950,00
		7805	SM-2-14/F (II 230)	1	978,00
		7806	ST-2-19/F (III 230)	1,5	1.193,00
		7807	ST-2-19/F (III 400)	1,5	1.110,00
		7808	SM-2-19/F (II 230)	1,5	1.137,00
		7809	ST-2-25/F (III 230)	2	1.388,00

Electrobombas sumergibles centrífugas multicelulares Serie 4" (con motor Franklin)

57	Pág Catálogo	Código	Modelo	C.V.	P.V.P. Euros
		7810	ST-2-25/F (III 400)	2	1.289,00
		7811	SM-2-25/F (II 230)	2	1.384,00
		7812	ST-2-35/F (III 230)	3	1.762,00
		7813	ST-2-35/F (III 400)	3	1.610,00
		7814	SM-2-35/F (II 230)	3	1.761,00
		7815	ST-4-8/F (III 230)	0,75	953,00
		7816	ST-4-8/F (III 400)	0,75	881,00
		7817	SM-4-8/F (II 230)	0,75	901,00
		7818	ST-4-10/F (III 230)	1	1.038,00
		7819	ST-4-10/F (III 400)	1	962,00
		7820	SM-4-10/F (II 230)	1	990,00
		7821	ST-4-14/F (III 230)	1,5	1.193,00
		7822	ST-4-14/F (III 400)	1,5	1.110,00
		7823	SM-4-14/F (II 230)	1,5	1.137,00
		7824	ST-4-19/F (III 230)	2	1.389,00
		7825	ST-4-19/F (III 400)	2	1.288,00
		7826	SM-4-19/F (II 230)	2	1.384,00
		7827	ST-4-26/F (III 230)	3	1.720,00
		7828	ST-4-26/F (III 400)	3	1.594,00
		7829	SM-4-26/F (II 230)	3	1.745,00
		7830	ST-4-34/F (III 230)	4	2.038,00
		7831	ST-4-34/F (III 400)	4	1.889,00
		7832	ST-4-44/F (III 230)	5,5	2.690,00
		7833	ST-4-44/F (III 400)	5,5	2.494,00
		7834	ST-8-7/F (III 230)	1	1.003,00
		7835	ST-8-7/F (III 400)	1	927,00
		7836	SM-8-7/F (II 230)	1	956,00
		7837	ST-8-9/F (III 230)	1,5	1.154,00
		7838	ST-8-9/F (III 400)	1,5	1.071,00
		7839	SM-8-9/F (II 230)	1,5	1.098,00
		7840	ST-8-11/F (III 230)	2	1.321,00
		7841	ST-8-11/F (III 400)	2	1.222,00
		7842	SM-8-11/F (II 230)	2	1.317,00
	7843	ST-8-16/F (III 230)	3	1.641,00	
	7844	ST-8-16/F (III 400)	3	1.516,00	
	7845	SM-8-16/F (II 230)	3	1.667,00	
	7846	ST-8-20/F (III 230)	4	1.955,00	
	7847	ST-8-20/F (III 400)	4	1.807,00	
	7848	ST-8-24/F (III 230)	5,5	2.556,00	
	7849	ST-8-24/F (III 400)	5,5	2.360,00	
	7850	ST-8-32/F (III 230)	7,5	2.994,00	
	7851	ST-8-32/F (III 400)	7,5	2.765,00	

Electrobombas sumergibles centrífugas multicelulares Serie 4" (con motor Franklin)

57	Continuación	Código	Modelo	C.V.	P.V.P. Euros
		7788	ST-11-7/F (III 230)	2	1.479,00
		7789	ST-11-7/F (III 400)	2	1.376,00
		7790	SM-11-7/F (II 230)	2	1.473,00
		7791	ST-11-10/F (III 230)	3	1.837,00
		7792	ST-11-10/F (III 400)	3	1.709,00
		7793	SM-11-10/F (II 230)	3	1.862,00
		7794	ST-11-14/F (III 230)	4	2.224,00
		7795	ST-11-14/F (III 400)	4	2.071,00
		7796	ST-11-19/F (III 230)	5,5	2.955,00
		7797	ST-11-19/F (III 400)	5,5	2.753,00
		7798	ST-11-26/F (III 230)	7,5	3.573,00
		7799	ST-11-26/F (III 400)	7,5	3.338,00
		7864	ST-20-8/F (III 230)	3	1.845,00
		7865	ST-20-8/F (III 400)	3	1.717,00
		7866	SM-20-8/F (II 230)	3	1.870,00
		7867	ST-20-11/F (III 230)	4	2.240,00
		7868	ST-20-11/F (III 400)	4	2.087,00
		7869	ST-20-15/F (III 230)	5,5	2.950,00
		7870	ST-20-15/F (III 400)	5,5	2.748,00
		7871	ST-20-20/F (III 230)	7,5	3.504,00
		7872	ST-20-20/F (III 400)	7,5	3.270,00

Electrobombas sumergibles centrífugas multicelulares Serie Inox 4" (con motor baño aceite)

58	Pág Catálogo	Código	Modelo	C.V.	P.V.P. Euros
		7962	IX ST-10-13/S (III 230)	0,75	726,00
		7660	IX ST-10-13/S (III 400)	0,75	726,00
		7661	IX SM-10-13/S (II 230)	0,75	736,00
		7963	IX ST-10-18/S (III 230)	1	873,00
		7662	IX ST-10-18/S (III 400)	1	873,00
		7663	IX SM-10-18/S (II 230)	1	886,00
		7964	IX ST-10-23/S (III 230)	1,5	1.034,00
		7664	IX ST-10-23/S (III 400)	1,5	1.034,00
		7665	IX SM-10-23/S (II 230)	1,5	1.049,00
		7965	IX ST-10-33/S (III 230)	2	1.451,00
		7666	IX ST-10-33/S (III 400)	2	1.451,00
		7667	IX SM-10-33/S (II 230)	2	1.477,00
		7966	IX ST-10-48/S (III 230)	3	2.037,00
		7668	IX ST-10-48/S (III 400)	3	2.037,00
		7669	IX SM-10-48/S (II 230)	3	2.071,00

Electrobombas sumergibles centrífugas multicelulares Serie Inox 4" (con motor baño aceite)

58	Pág Catálogo	Código	Modelo	C.V.	P.V.P. Euros
		7967	IX ST-18-9/S (III 230)	0,75	713,00
		7670	IX ST-18-9/S (III 400)	0,75	713,00
		7671	IX SM-18-9/S (II 230)	0,75	723,00
		7968	IX ST-18-12/S (III 230)	1	728,00
		7672	IX ST-18-12/S (III 400)	1	728,00
		7673	IX SM-18-12/S (II 230)	1	742,00
		7969	IX ST-18-15/S (III 230)	1,5	958,00
		7674	IX ST-18-15/S (III 400)	1,5	958,00
		7675	IX SM-18-15/S (II 230)	1,5	973,00
		7970	IX ST-18-18/S (III 230)	1,5	705,00
		7676	IX ST-18-18/S (III 400)	1,5	905,00
		7677	IX SM-18-18/S (II 230)	1,5	919,00
		7971	IX ST-18-25/S (III 230)	2	1.134,00
		7678	IX ST-18-25/S (III 400)	2	1.134,00
		7679	IX SM-18-25/S (II 230)	2	1.160,00
		7972	IX ST-18-33/S (III 230)	3	1.490,00
		7680	IX ST-18-33/S (III 400)	3	1.490,00
		7681	IX SM-18-33/S (II 230)	3	1.523,00
		7682	IX ST-18-45/S (III 400)	4	2.066,00
		7973	IX ST-25-8/S (III 230)	1	642,00
		7683	IX ST-25-8/S (III 400)	1	642,00
		7684	IX SM-25-8/S (II 230)	1	656,00
		7974	IX ST-25-12/S (III 230)	1,5	767,00
		7685	IX ST-25-12/S (III 400)	1,5	767,00
		7686	IX SM-25-12/S (II 230)	1,5	781,00
		7975	IX ST-25-17/S (III 230)	2	945,00
		7687	IX ST-25-17/S (III 400)	2	945,00
		7688	IX SM-25-17/S (II 230)	2	972,00
		7976	IX ST-25-25/S (III 230)	3	1.227,00
		7689	IX ST-25-25/S (III 400)	3	1.227,00
		7690	IX SM-25-25/S (II 230)	3	1.260,00
		7691	IX ST-25-33/S (III 400)	4	1.599,00
		7692	IX ST-25-44/S (III 400)	5,5	2.253,00
		7977	IX ST-40-7/S (III 230)	1,5	1.021,00
		7693	IX ST-40-7/S (III 400)	1,5	1.021,00
		7694	IX SM-40-7/S (II 230)	1,5	1.035,00
		7978	IX ST-40-10/S (III 230)	2	1.271,00
		7695	IX ST-40-10/S (III 400)	2	1.271,00
		7696	IX SM-40-10/S (II 230)	2	1.298,00
		7979	IX ST-40-15/S (III 230)	3	1.694,00
		7697	IX ST-40-15/S (III 400)	3	1.694,00
		7698	IX SM-40-15/S (II 230)	3	1.727,00
		7699	IX ST-40-18/S (III 400)	4	2.008,00
		7700	IX ST-40-25/S (III 400)	5,5	2.703,00
		7701	IX ST-40-37/S (III 400)	7,5	4.096,00

Electrobombas sumergibles centrífugas multicelulares Serie Inox 4" (con motor baño aceite)

58	Pág Catálogo	Código	Modelo	C.V.	P.V.P. Euros
		7980	IX ST-70-5/S (III 230)	2	1.150,00
		7702	IX ST-70-5/S (III 400)	2	1.150,00
		7703	IX SM-70-5/S (II 230)	2	1.176,00
		7981	IX ST-70-7/S (III 230)	3	1.436,00
		7704	IX ST-70-7/S (III 400)	3	1.436,00
		7705	IX SM-70-7/S (II 230)	3	1.469,00
		7706	IX ST-70-10/S (III 400)	4	1.859,00
		7707	IX ST-70-13/S (III 400)	5,5	2.396,00
		7708	IX ST-70-18/S (III 400)	7,5	3.238,00

Electrobombas sumergibles centrífugas multicelulares Serie Inox 4" (con motor Franklin)

58	Continuación	Código	Modelo	C.V.	P.V.P. Euros
		7500	IX ST-10-13/F (III 230)	0,75	1.281,00
		7501	IX ST-10-13/F (III 400)	0,75	1.210,00
		7502	IX SM-10-13/F (II 230)	0,75	1.228,00
		7503	IX ST-10-18/F (III 230)	1	1.462,00
		7504	IX ST-10-18/F (III 400)	1	1.385,00
		7505	IX SM-10-18/F (II 230)	1	1.413,00
		7506	IX ST-10-23/F (III 230)	1,5	1.722,00
		7507	IX ST-10-23/F (III 400)	1,5	1.640,00
		7508	IX SM-10-23/F (II 230)	1,5	1.667,00
		7509	IX ST-10-33/F (III 230)	2	2.257,00
		7510	IX ST-10-33/F (III 400)	2	2.154,00
		7511	IX SM-10-33/F (II 230)	2	2.252,00
		7546	IX ST-10-48/F (III 230)	3	3.046,00
		7547	IX ST-10-48/F (III 400)	3	2.920,00
		7548	IX SM-10-48/F (II 230)	3	3.071,00
		7512	IX ST-18-9/F (III 230)	0,75	1.269,00
		7513	IX ST-18-9/F (III 400)	0,75	1.195,00
		7514	IX SM-18-9/F (II 230)	0,75	1.216,00
		7515	IX ST-18-12/F (III 230)	1	1.314,00
		7516	IX ST-18-12/F (III 400)	1	1.237,00
		7517	IX SM-18-12/F (II 230)	1	1.264,00
		7518	IX ST-18-15/F (III 230)	1,5	1.645,00
		7519	IX ST-18-15/F (III 400)	1,5	1.563,00
		7520	IX SM-18-15/F (II 230)	1,5	1.590,00
		7527	IX ST-18-18/F (III 230)	1,5	1.591,00
		7528	IX ST-18-18/F (III 400)	1,5	1.508,00
		7529	IX SM-18-18/F (II 230)	1,5	1.535,00
		7521	IX ST-18-25/F (III 230)	2	1.930,00
		7522	IX ST-18-25/F (III 400)	2	1.827,00
		7523	IX SM-18-25/F (II 230)	2	1.924,00
		7524	IX ST-18-33/F (III 230)	3	2.482,00
		7525	IX ST-18-33/F (III 400)	3	2.357,00
		7526	IX SM-18-33/F (II 230)	3	2.507,00
		7576	IX ST-18-45/F (III 230)	4	3.229,00
		7577	IX ST-18-45/F (III 400)	4	3.079,00

Electrobombas sumergibles centrifugas multicelulares Serie Inox 4'' (con motor Franklin)

58	Continuación	Código	Modelo	C.V.	P.V.P. Euros
		7530	IX ST-25-8/F (III 230)	1	1.224,00
		7531	IX ST-25-8/F (III 400)	1	1.147,00
		7532	IX SM-25-8/F (II 230)	1	1.175,00
		7533	IX ST-25-12/F (III 230)	1,5	1.449,00
		7534	IX ST-25-12/F (III 400)	1,5	1.366,00
		7535	IX SM-25-12/F (II 230)	1,5	1.393,00
		7536	IX ST-25-17/F (III 230)	2	1.735,00
		7537	IX ST-25-17/F (III 400)	2	1.633,00
		7538	IX SM-25-17/F (II 230)	2	1.728,00
		7539	IX ST-25-25/F (III 230)	3	2.212,00
		7540	IX ST-25-25/F (III 400)	3	2.085,00
		7541	IX SM-25-25/F (II 230)	3	2.237,00
		7542	IX ST-25-33/F (III 230)	4	2.749,00
		7543	IX ST-25-33/F (III 400)	4	2.599,00
		7544	IX ST-25-44/F (III 230)	5,5	3.744,00
		7545	IX ST-25-44/F (III 400)	5,5	3.544,00
		7549	IX ST-40-7/F (III 230)	1,5	1.710,00
		7550	IX ST-40-7/F (III 400)	1,5	1.628,00
		7551	IX SM-40-7/F (II 230)	1,5	1.654,00
		7552	IX ST-40-10/F (III 230)	2	2.071,00
		7553	IX ST-40-10/F (III 400)	2	1.969,00
		7554	IX SM-40-10/F (II 230)	2	2.065,00
		7555	IX ST-40-15/F (III 230)	3	2.693,00
		7556	IX ST-40-15/F (III 400)	3	2.567,00
		7557	IX SM-40-15/F (II 230)	3	2.718,00
		7558	IX ST-40-18/F (III 230)	4	3.171,00
		7559	IX ST-40-18/F (III 400)	4	3.020,00
		7560	IX ST-40-25/F (III 230)	5,5	4.206,00
		7561	IX ST-40-25/F (III 400)	5,5	4.005,00
		7562	IX ST-40-37/F (III 230)	7,5	5.397,00
		7563	IX ST-40-37/F (III 400)	7,5	5.166,00
		7564	IX ST-70-5/F (III 230)	2	1.945,00
		7565	IX ST-70-5/F (III 400)	2	1.844,00
	7566	IX SM-70-5/F (II 230)	2	1.940,00	
	7567	IX ST-70-7/F (III 230)	3	2.426,00	
	7568	IX ST-70-7/F (III 400)	3	2.300,00	
	7569	IX SM-70-7/F (II 230)	3	2.452,00	
	7570	IX ST-70-10/F (III 230)	4	3.018,00	
	7571	IX ST-70-10/F (III 400)	4	2.852,00	
	7572	IX ST-70-13/F (III 230)	5,5	3.880,00	
	7573	IX ST-70-13/F (III 400)	5,5	3.691,00	
	7574	IX ST-70-18/F (III 230)	7,5	4.513,00	
	7575	IX ST-70-18/F (III 400)	7,5	4.282,00	

Electrobombas sumergibles centrífugas multicelulares Serie 6''

59	Pág Catálogo	Código	Modelo	C.V.	P.V.P. Euros	
		SERIE 6'' INOXIDABLE			Consultar	

Condensadores para motores monofásicos

Pág Catálogo	Código	Modelo	P.V.P. Euros
	2429	CONDENSADOR 18 μ F	8,10
	2400	CONDENSADOR 20 μ F	8,30
	2416	CONDENSADOR 25 μ F	10,00
	2401	CONDENSADOR 30 μ F	10,80
	2417	CONDENSADOR 35 μ F	12,30
	2402	CONDENSADOR 40 μ F	13,40
	2399	CONDENSADOR 45 μ F	14,70
	2403	CONDENSADOR 50 μ F	15,20
	2418	CONDENSADOR 60 μ F	18,20
	2404	CONDENSADOR 70 μ F	19,60
	2419	CONDENSADOR 80 μ F	23,10

Empalmes sumergibles

Pág Catálogo	Código	Modelo	P.V.P. Euros
	2173	EMPALME SUMERGIDO TERMORETRACTIL	8,00
	2297	EMPALME SUMERGIDO DE RESINA	65,00

Cable eléctrico

Pág Catálogo	Código	Modelo	P.V.P. Euros
	2184	METRO CABLE ELÉCTRICO SUMERGIDO 4 x 1'5 MM.	6,60
	2185	METRO CABLE ELÉCTRICO SUMERGIDO 4 x 2'5 MM.	8,00

Motores "baño aceite" para bombas de 4"

60	Pág Catálogo	Código	Modelo	C.V.	P.V.P. Euros
		2655	MOTOR BAÑO ACEITE 4" (III 230)	0,75	247,00
		2435	MOTOR BAÑO ACEITE 4" (III 400)	0,75	247,00
		2436	MOTOR BAÑO ACEITE 4" (II 230)	0,75	247,00
		2656	MOTOR BAÑO ACEITE 4" (III 230)	1	268,00
		2437	MOTOR BAÑO ACEITE 4" (III 400)	1	268,00
		2438	MOTOR BAÑO ACEITE 4" (II 230)	1	268,00
		2657	MOTOR BAÑO ACEITE 4" (III 230)	1,5	300,00
		2439	MOTOR BAÑO ACEITE 4" (III 400)	1,5	300,00
		2440	MOTOR BAÑO ACEITE 4" (II 230)	1,5	300,00
		2658	MOTOR BAÑO ACEITE 4" (III 230)	2	343,00
		2441	MOTOR BAÑO ACEITE 4" (III 400)	2	343,00
		2442	MOTOR BAÑO ACEITE 4" (II 230)	2	354,00
		2659	MOTOR BAÑO ACEITE 4" (III 230)	3	418,00
		2443	MOTOR BAÑO ACEITE 4" (III 400)	3	418,00
		2444	MOTOR BAÑO ACEITE 4" (II 230)	3	428,00
		2445	MOTOR BAÑO ACEITE 4" (III 400)	4	525,00
		2446	MOTOR BAÑO ACEITE 4" (III 400)	5,5	733,00
	2447	MOTOR BAÑO ACEITE 4" (III 400)	7,5	1.302,00	

Motores Franklin para bombas de 4"

61	Pág Catálogo	Código	Modelo	C.V.	P.V.P. Euros
		2255	MOTOR FRANKLIN 4" (III 230)	0,75	803,00
		2256	MOTOR FRANKLIN 4" (III 400)	0,75	730,00
		2257	MOTOR FRANKLIN 4" (II 230)	0,75	741,00
		2258	MOTOR FRANKLIN 4" (III 230)	1	856,00
		2259	MOTOR FRANKLIN 4" (III 400)	1	778,00
		2260	MOTOR FRANKLIN 4" (II 230)	1	794,00
		2261	MOTOR FRANKLIN 4" (III 230)	1,5	986,00
		2262	MOTOR FRANKLIN 4" (III 400)	1,5	902,00
		2263	MOTOR FRANKLIN 4" (II 230)	1,5	916,00
		2264	MOTOR FRANKLIN 4" (III 230)	2	1.136,00
		2265	MOTOR FRANKLIN 4" (III 400)	2	1.033,00
		2266	MOTOR FRANKLIN 4" (II 230)	2	1.115,00
		2267	MOTOR FRANKLIN 4" (III 230)	3	1.405,00
		2268	MOTOR FRANKLIN 4" (III 400)	3	1.278,00
		2288	MOTOR FRANKLIN 4" (II 230)	3	1.411,00
		2269	MOTOR FRANKLIN 4" (III 230)	4	1.675,00
		2270	MOTOR FRANKLIN 4" (III 400)	4	1.523,00
		2271	MOTOR FRANKLIN 4" (III 230)	5,5	2.221,00
		2272	MOTOR FRANKLIN 4" (III 400)	5,5	2.019,00
		2249	MOTOR FRANKLIN 4" (III 230)	7,5	2.577,00
	2250	MOTOR FRANKLIN 4" (III 400)	7,5	2.343,00	
	2346	ÁNODO DE SACRIFICIO PARA MOTORES FRANKLIN 4"			92,60

Motores Franklin para bombas de 6"

61	Pág Catálogo	Código	Modelo	C.V.	P.V.P. Euros
		2273	MOTOR FRANKLIN 6" DIRECTO	5,5	3.519,00
		2274	MOTOR FRANKLIN 6" E/T	5,5	3.794,00
		2275	MOTOR FRANKLIN 6" DIRECTO	7,5	3.633,00
		2276	MOTOR FRANKLIN 6" E/T	7,5	3.909,00
		2277	MOTOR FRANKLIN 6" DIRECTO	10	3.823,00
		2278	MOTOR FRANKLIN 6" E/T	10	4.099,00
		2279	MOTOR FRANKLIN 6" DIRECTO	15	4.291,00
		2280	MOTOR FRANKLIN 6" E/T	15	4.567,00
		2282	MOTOR FRANKLIN 6" E/T	20	5.275,00
		2284	MOTOR FRANKLIN 6" E/T	25	5.696,00
		2286	MOTOR FRANKLIN 6" E/T	30	6.357,00

Camisas de refrigeración para motores sumergibles

62	Pág Catálogo	Código	Modelo	P.V.P. Euros
		2448	CAMISA REFRIGERACIÓN MOTOR 4" P-1	461,00
		2524	CAMISA REFRIGERACIÓN MOTOR 4-6" P-2	674,00
		2525	CAMISA REFRIGERACIÓN MOTOR 6" P-3	1.195,00
		2526	CAMISA REFRIGERACIÓN MOTOR 6" P-4	1.242,00
		2527	CAMISA REFRIGERACIÓN MOTOR 6" P-5	1.277,00
		2449	CAMISA REFRIGERACIÓN MOTOR 4" DH-1	691,00
		2547	CAMISA REFRIGERACIÓN MOTOR 4-6" DH-2	898,00
		2548	CAMISA REFRIGERACIÓN MOTOR 6" DH-3	1.490,00
		2549	CAMISA REFRIGERACIÓN MOTOR 6" DH-4	1.490,00
		2550	CAMISA REFRIGERACIÓN MOTOR 6" DH-5	1.546,00

Presostatos electrónicos con manómetro digital integrado Serie Switchmatic

63	Pág Catálogo	Código	Modelo	P.V.P. Euros
		2597	SWITCHMATIC 2 II HASTA 3 CV.	106,00
		2596	SWITCHMATIC 2T III HASTA 5,5 CV.	230,00
		2598	KIT SWITCHMATIC 2 II HASTA 3 CV.	124,00
		2588	SWITCHMATIC 3 II 230 V	75,00

Presostatos

63	Pág Catálogo	Código	Modelo	P.V.P. Euros
		2126	PRESOSTATO FAC-1	18,00
		2127	PRESOSTATO FAC-2	21,00
		2129	PRESOSTATO FSG-2	35,00
		2130	PRESOSTATO FYG-22	55,00
		2131	PRESOSTATO FYG-32	58,00
		2118	PRESOSTATO FAC GAS-OIL	81,00
		2115	PRESOSTATO TELEM 6 Kg.	44,00
		2098	PRESOSTATO TELEM 12 Kg.	47,00
		2064	PRESOSTATO TELEM 25 Kg.	102,00
		2132	PRESOSTATO INVERSOR XMx 6 KG. (MINIMA)	83,00
		2065	PRESOSTATO INVERSOR XMx 12 KG. (MINIMA)	96,00
	2066	PRESOSTATO INVERSOR XMx 25 KG. (MINIMA)	122,00	

Reguladores de presión Serie Logicpress

64	Pág Catálogo	Código	Modelo	P.V.P. Euros
		2706	LOGICPRESS	111,00
		2716	LOGICPRESS/SET	133,00
		2726	MANÓMETRO "LOGICPRESS-LOGICPRESS/SET" 0-12 KG/CM2	17,00
		2728	CIRCUITO ELECTRÓNICO "LOGICPRESS"	Consultar
		2729	CIRCUITO ELECTRÓNICO "LOGICPRESS/SET"	Consultar
		2727	MEMBRANA "LOGICPRESS-LOGICPRESS/SET"	Consultar

Reguladores de presión Serie Presscontrol

65	Pág Catálogo	Código	Modelo	P.V.P. Euros
		2212	ECOPRES	111,00
		2213	PRESSCONTROL	129,00
		2216	MASCONTROL II 1 1/4"	205,00
		2220	MASCONTROL-UP III 1 1/4"	500,00
		2296	MASCONTROL - NAUTICAL 24 V. 1 1/4"	230,00
		2235	CONTROLPRES REGULABLE 1 1/4"	345,00
		2219	CIRCUITO ELECTRÓNICO ECOPRESS	Consultar
		2214	CIRCUITO ELECTRÓNICO PRESSCONTROL	Consultar
		2217	CIRCUITO ELECTRÓNICO MASCONTROL	Consultar
		2218	RACORD 2 PIEZAS CONEXIÓN REGULADOR M-H 1"	4,20
	2366	MEMBRANA PRESSCONTROL	Consultar	

Controladores de bombas mural con variador de frecuencia Serie Speedbox

66	Pág Catálogo	Código	Modelo	P.V.P. Euros
		2589	SPEEDBOX 1112 MM II 230 V 12 AMP.	979,00
		2591	SPEEDBOX 1010 MT II 230 V 10 AMP.	996,00
		2593	SPEEDBOX 1305 TT III 400 V 5 AMP.	1.138,00
		2594	SPEEDBOX 1309 TT III 400 V 9 AMP.	1.256,00
		2595	SPEEDBOX 1314 TT III 400 V 14 AMP.	1.462,00

Controladores de bombas mural con variador de frecuencia Serie Speedbox

67	Pág Catálogo	Código	Modelo	P.V.P. Euros
		2586	SPEEDBOX DUO MT II 230 V 10 AMP.	1.622,00
		2587	SPEEDBOX DUO SET TT III 400 V 9 AMP.	1.866,00

Controladores de bombas on-board con variador de frecuencia Serie Speedboard

68	Pág Catálogo	Código	Modelo	P.V.P. Euros
		2457	SPEEDBOARD 1010 MT II 230 V 10 AMP.	1.015,00
		2458	SPEEDBOARD 1305 TT III 400 V 5 AMP.	1.188,00
		2459	SPEEDBOARD 1309 TT III 400 V 9 AMP.	1.266,00

Filtros para agua

70	Pág Catálogo	Código	Modelo	P.V.P. Euros
		2189	PORTACARTUCHOS VACIO 1" x 9 3/4"	39,00
		2190	CARTUCHO HILO BOBINADO 25 MICRAS	6,00
		2192	CARTUCHO RED LAVABLE 50 MICRAS	14,00
		2193	CARTUCHO CARBÓN ACTIVO	26,10
		2194	CARTUCHO SALES POLIFOSFATOS	44,00
		2195	LLAVE APRIETE / APERTURA PORTACARTUCHOS	10,00
		2196	SOPORTE ANGULAR FIJACIÓN PORTACARTUCHOS	8,00



Filtros para red y descalcificación

71	Pág Catálogo	Código	Modelo	P.V.P. Euros
		2426	FILTRO "MICRO" 3/8"	31,00
		2427	DESCALCIFICADOR "DOSAL" 3/4"	23,00
		2428	ENVASE SALES POLIFOSFATOS 0,5 KG.	32,00

Depósitos de membrana fija Serie Hasabox-MF

72	Pág Catálogo	Código	Modelo	Kg/cm3	P.V.P. Euros
		2610	HASABOX-MF 2 L.	10	45,00
		2611	HASABOX-MF 5 L.	10	74,50
		2612	HASABOX-MF 8 L.	10	78,10
		2613	HASABOX-MF 12 L.	10	85,20
		2614	HASABOX-MF 19 L.	10	94,00
		2615	HASABOX-MF 24 L.	10	103,00
		2616	HASABOX-MFH 24 L.	10	126,00
		2617	HASABOX-MF 36 L.	10	147,00
		2618	HASABOX-MF 50 L.	10	229,00
		2619	HASABOX-MFH 50 L.	10	247,00
		2620	HASABOX-MFV 50 L.	10	243,00
		2621	HASABOX-MFH 80 L.	10	367,00
		2622	HASABOX-MFV 80 L.	10	359,00
		2623	HASABOX-MFH 100 L.	10	445,00
		2624	HASABOX-MFV 100 L.	10	435,00
	2625	HASABOX-MFV 150 L.	10	617,00	

Depósitos de membrana recambiable Serie Hasabox

73	Pág Catálogo	Código	Modelo	Kg/cm3	P.V.P. Euros
 		2002	HASABOX 24 L.	10	66,00
		2289	HASABOX 24 L.	25	550,00
		2290	HASABOX 24 L.	16	171,00
		2291	HASABOX 24 L. H (Horizontal)	10	93,00
		2030	HASABOX 24 L. INOX	8	383,00
		2022	HASABOX 50 L. S/PATAS	10	191,00
		2023	HASABOX 50 L. S/PATAS	16	525,00
		2049	HASABOX 50 L. H (Horizontal)	10	183,00
		2019	HASABOX 50 L. V	10	174,00
		2010	HASABOX 100 L. V	10	368,00
		2011	HASABOX 150 L.	10	545,00
		2012	HASABOX 200 L.	10	661,00
		2014	HASABOX 300 L.	10	841,00
		2016	HASABOX 500 L.	10	1.145,00
		2038	HASABOX 700 L.	8	2.336,00
		2018	HASABOX 700 L.	10	3.444,00

Membranas recambiables y bridas para Hasabox

	Pág Catálogo	Código	Modelo	P.V.P. Euros
		2004	MEMBRANA HASABOX 5 L.	13,50
		2006	MEMBRANA HASABOX 24 L.	13,50
		2024	MEMBRANA HASABOX 50 L.	43,00
		2045	MEMBRANA HASABOX 80/100 L.	81,00
		2046	MEMBRANA HASABOX 150/200 L.	156,00
		2053	MEMBRANA HASABOX 150 LTS. (06-2015)	103,00
		2047	MEMBRANA HASABOX 300 L.	188,00
		2048	MEMBRANA HASABOX 500 L.	288,00
		2107	BRIDA HASABOX 24/50 L. 3/4" o 1"	27,00
		2096	BRIDA HASABOX INOX 24/50 L. 3/4" o 1"	67,00

Depósitos hidroneumáticos de membrana Serie Challenger

74	Pág Catálogo	Código	Modelo	P.V.P. Euros
		2572	CHALLENGER 200	1.456,00
		2573	CHALLENGER 250	1.603,00
		2574	CHALLENGER 300	2.068,00
		2575	CHALLENGER 450	2.870,00

Depósitos hidroneumáticos de membrana Serie Pressure Wave

74	Pág Catálogo	Código	Modelo	P.V.P. Euros
		2583	PWB - 2	49,00
		2576	PWB - 8	105,00
		2577	PWB - 18	133,00
		2578	PEWB - 24	126,00
		2579	PWB - 60 H	399,00
		2580	PWB - 80 H	498,00
		2581	PWB - 60 V	383,00
		2582	PWB - 80 V	452,00
		2570	PWB - 100 V	618,00
		2571	PWB - 130 V	843,00
		2584	PWB - 150 V	877,00

Depósitos hidroneumáticos de membrana Serie C2 - Lite CAD

75	Pág Catálogo	Código	Modelo	P.V.P. Euros
		2350	C2 - LITE CAD C2B - 60	734,00
		2351	C2 - LITE CAD C2B - 80	823,00
		2352	C2 - LITE CAD C2B - 100	1.075,00
		2353	C2 - LITE CAD C2B - 130	1.234,00
		2354	C2 - LITE CAD C2B - 200	1.645,00
		2355	C2 - LITE CAD C2B - 250	1.865,00
		2356	C2 - LITE CAD C2B - 300	2.084,00
		2357	C2 - LITE CAD C2B - 350	2.445,00
		2358	C2 - LITE CAD C2B - 450	3.311,00

Vasos de expansión para hidrocarburos

76	Pág Catálogo	Código	Modelo	P.V.P. Euros
		2530	VASO HIDROCARBUROS 5 L.	117,00
		2531	VASO HIDROCARBUROS 8 L.	128,00
		2532	VASO HIDROCARBUROS 15 L.	137,00
		2529	VASO HIDROCARBUROS 24 L.	168,00

Depósitos hidroneumáticos galvanizados

77	Pág Catálogo	Código	Modelo	Kg/cm3	P.V.P. Euros
		2079	GALVANIZADO 100 L.	10	1.157,00
		2080	GALVANIZADO 200 L.	10	1.512,00
		2081	GALVANIZADO 300 L.	10	1.697,00
		2082	GALVANIZADO 500 L.	10	2.702,00
		2069	GALVANIZADO 750 L.	8	3.292,00
		2071	GALVANIZADO 1000 L.	8	4.391,00
		2073	GALVANIZADO 1500 L.	8	8.130,00
		2074	GALVANIZADO 2000 L.	8	11.095,00

Inyectores de aire

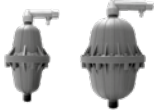
77	Pág Catálogo	Código	Modelo	P.V.P. Euros
		2061	INYECTOR MINI HASTA 500 L.	76,00
		2062	INYECTOR MIDI HASTA 2.000 L.	130,00

Grupos de presión compactos con acumulación Serie Aquacompact

78-81	Pág Catálogo	Código	Modelo	P.V.P. Euros
		3758	KIT AQUACOMPACT 300 Lts./NIZABOX 43/LOGICPRESS	1.604,00
		3759	KIT AQUACOMPACT 300 Lts./NIZABOX 44/LOGICPRESS	1.638,00
		3764	KIT AQUACOMPACT 300 Lts./ATENAS 103 M	1.628,00
		3765	KIT AQUACOMPACT 300 Lts./ATENAS 104 M	1.729,00
		3770	KIT AQUACOMPACT - 480 Lts./NIZABOX43/LOGICPRESS	1.792,00
		3771	KIT AQUACOMPACT - 480 Lts./NIZABOX44/LOGICPRESS	1.823,00
		3775	KIT AQUACOMPACT - 480 Lts./ATENAS 103 M	1.813,00
		3776	KIT AQUACOMPACT - 480 Lts./ATENAS 104 M	1.916,00
		3760	KIT AQUACOMPACT - 500	2.673,00
		3761	KIT AQUACOMPACT - 700	3.087,00
		3762	KIT AQUACOMPACT - 1100	3.407,00
		3763	KIT AQUACOMPACT - 2000	4.533,00

Interruptores de nivel

82	Pág Catálogo	Código	Modelo	P.V.P. Euros
		2116	INTERRUPTOR DE NIVEL "HASA 85" 2 MTS. (Doble cámara)	27,00
		2063	INTERRUPTOR DE NIVEL "HASA 85" 5 MTS. (Doble cámara)	35,00
		2044	INTERRUPTOR DE NIVEL "HASA 85" 10 MTS. (Doble cámara)	49,00
		2113	INTERRUPTOR DE NIVEL "KEY" (Cámara simple)	23,00
		2097	INTERRUPTOR DE NIVEL "ILA"	92,00
		2041	INTERRUPTOR DE NIVEL "ILA-GASOIL"	91,60
		2043	INTERRUPTOR DE NIVEL "AGUAS RESIDUALES" 5 MTS.	100,00
		2060	INTERRUPTOR DE NIVEL "AGUAS RESIDUALES" 10 MTS.	125,00
		2051	INTERRUPTOR DE NIVEL "RESIDUAL ATEX - EX" 10 MTS.	189,00
		2052	BARRERA INTRINSECA "ATEX-EX" MONOFÁSICA 2 CANALES	445,00

Juegos de cables y mangueras flexibles

	Pág Catálogo	Código	Modelo	P.V.P. Euros
		2134	JUEGO DE CABLES PARA PRESOSTATO	5,50
		2186	JUEGO DE CABLES PARA LOGICPRESS - PRESSCONTROL	5,50
		2158	MANGUERA FLEXIBLE 900 mm. Ø 1"	58,00
		2162	LATIGUILLO FLEXIBLE 700 mm. Ø 3/4"	50,00

Cuadros eléctricos de protección y maniobra

83-86 Pág Catálogo	Código Modelo	P.V.P. Euros
	<u>CUADROS PARA GRUPOS DE PRESIÓN</u>	
	2144 CUADRO ELÉCTRICO SIMPLE PARA GRUPO DE PRESIÓN III 400 V. HASTA 5,5 C.V.	233,00
	2146 CUADRO ELÉCTRICO SIMPLE PARA GRUPO DE PRESIÓN II 230 V. HASTA 2 C.V.	222,00
	2170 CUADRO DOBLE CON ALTERNANCIA MULTIFUNCIÓN 13 AMP.	350,00
	2377 CUADRO ELÉCTRICO TRIPLE CON ALTERNANCIA III 400 V. HASTA 5,5 C.V.	1.036,00
	<u>CUADROS PARA AGUAS RESIDUALES</u>	
	2165 CUADRO ELÉCTRICO SIMPLE PARA AGUAS RESIDUALES II 230 V. HASTA 2 C.V. CON ALARMAS ÓPTICA Y ACÚST.	281,00
	2168 CUADRO ELÉCTRICO SIMPLE PARA AGUAS RESIDUALES III 400 V. HASTA 5,5 C.V. CON ALARMAS ÓPTICA Y ACÚST.	305,00
	2169 CUADRO ELÉCTRICO DOBLE PARA AGUAS RESIDUALES II 230 V. HASTA 1,5 C.V. Y III 400V HASTA 5,5 C.V. CON ALTERNANCIA Y ALARMAS.	587,00
	2753 LOGICPANEL SEWAGE DOBLE M2HP II 230V 10A + SENSOR	629,00
2754 LOGICPANEL SEWAGE DOBLE T4HP III 400V 8A + SENSOR	1.146,00	
	<u>CUADROS PARA BOMBAS SUMERGIBLES 4"</u>	
	2391 CUADRO ELÉCTRICO CON SONDAS VACIADO POZO BOMBAS 4" III 400 V. HASTA 5,5 C.V.	301,00
	2388 CUADRO ELÉCTRICO CON SONDAS VACIADO POZO BOMBAS 4" II 230 V. HASTA 2 C.V.	291,00
	2387 CUADRO ELÉCTRICO CON SONDAS VACIADO POZO BOMBAS 4" II 230 V. HASTA 3 C.V.	376,00
	2395 CUADRO ELÉCTRICO CON SONDAS VACIADO POZO Y LLENADO DEPÓSITO BOMBAS 4" III 400 V. HASTA 5,5 C.V.	352,00
	2393 CUADRO ELÉCTRICO CON SONDAS VACIADO POZO Y LLENADO DEPÓSITO BOMBAS 4" II 230 V. HASTA 2 C.V.	343,00
	2394 CUADRO ELÉCTRICO CON SONDAS VACIADO POZO Y LLENADO DEPÓSITO BOMBAS 4" II 230 V. HASTA 3 C.V.	426,00
	2153 CUADRO PROTECCIÓN SIMPLE SIN SONDAS DIGITAL II 230V. 12 AMP.	396,00
	2142 CUADRO PROTECCIÓN SIMPLE SIN SONDAS DIGITAL II 230V. 25 AMP.	651,00
	2154 CUADRO PROTECCIÓN SIMPLE SIN SONDAS DIGITAL III 400 V. 12 AMP.	491,00
2161 SONDAS DE NIVEL	Consultar	

Cuadros eléctricos de protección y maniobra

83-86	Continuación	Código	Modelo	P.V.P. Euros
	<u>CUADROS PARA BOMBAS DE PISCINA</u>			
	2396	CUADRO FILTRACIÓN CON DIFERENCIAL II 230 V.		292,00
	2397	CUADRO FILTRACIÓN CON DIFERENCIAL II 230 V. + 1 TRANSF.		476,00
	2398	CUADRO FILTRACIÓN CON DIFERENCIAL II 230 V. + 2 TRANSF.		653,00

Colectores para grupos de presión

87	Pág Catálogo	Código	Modelo	P.V.P. Euros
	6228	COLECTOR INOX. EN AISI 304 PULIDO. DOBLE (1" X 1" X 1 1/2")		160,00
	6229	COLECTOR INOX. EN AISI 304 PULIDO. DOBLE (1 1/4" X 1 1/4" X 2")		190,00
	6230	COLECTOR INOX. EN AISI 304 PULIDO. DOBLE (1 1/2" X 1 1/2" X 2 1/2")		211,00
	6231	COLECTOR INOX. EN AISI 304 PULIDO. DOBLE (2" X 2" X 3")		256,00
	6248	COLECTOR INOX. EN AISI 304 PULIDO. TRIPLE (1 1/4" X 1 1/4" X 1 1/4" X 2")		317,00
	6232	COLECTOR INOX. EN AISI 304 PULIDO. TRIPLE (1 1/2" X 1 1/2" X 1 1/2" X 2 1/2")		345,00
	6245	COLECTOR INOX. EN AISI 304 PULIDO. TRIPLE (1 1/2" X 1 1/2" X 1 1/2" X 3")		350,00
	6246	COLECTOR INOX. EN AISI 304 PULIDO. TRIPLE (2" X 2" X 2" X 3")		373,00
	6247	COLECTOR C.I. "INOX 304" 1 1/2" X 1" X 2"		Consultar

Accesorios para grupos de presión - Bancadas

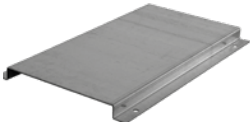
87	Pág Catálogo	Código	Modelo	P.V.P. Euros
	6250	BANCADAS DE CHAPA GALVANIZADA 300X270 M/M		49,00
	6252	BANCADAS DE CHAPA GALVANIZADA 700X450 M/M		112,00
	6253	BANCADAS DE CHAPA GALVANIZADA 1000X400 M/M		313,00
	6251	BANCADAS DE CHAPA GALVANIZADA 600X300 M/M		77,00
	6249	BANCADAS DE CHAPA GALVANIZADA 850X520 M/M		285,00
	6254	BANCADAS DE CHAPA GALVANIZADA 1200X800 M/M		510,00

Accesorios para grupos de presión - Válvulas de bola

87	Pág Catálogo	Código	Modelo	P.V.P. Euros
		2244	VÁLVULA DE BOLA 1"	18,00
		2245	VÁLVULA DE BOLA 1 1/4"	29,00
		2246	VÁLVULA DE BOLA 1 1/2"	40,00
		2247	VÁLVULA DE BOLA 2"	60,00
		2248	VÁLVULA DE BOLA 2 1/2"	129,00
		2406	VÁLVULA DE BOLA 3"	250,00
		2407	VÁLVULA DE BOLA 4"	380,00

Accesorios para grupos de presión - Válvulas de retención

87	Pág Catálogo	Código	Modelo	P.V.P. Euros
		2109	VÁLVULA DE RETENCIÓN CON OBTURADOR EN LATÓN 1"	18,40
		2110	VÁLVULA DE RETENCIÓN CON OBTURADOR EN LATÓN 1 1/4"	25,60
		2111	VÁLVULA DE RETENCIÓN CON OBTURADOR EN LATÓN 1 1/2"	36,50
		2112	VÁLVULA DE RETENCIÓN CON OBTURADOR EN LATÓN 2"	55,30
		2108	VÁLVULA DE RETENCIÓN CON OBTURADOR EN LATÓN 2 1/2"	120,00
		2105	VÁLVULA DE RETENCIÓN CON OBTURADOR EN LATÓN 3"	173,00
		2106	VÁLVULA DE RETENCIÓN CON OBTURADOR EN LATÓN 4"	270,00

Accesorios para grupos de presión - Soporte de cuadro

87	Pág Catálogo	Código	Modelo	P.V.P. Euros
		6256	SOPORTE DE CUADRO SIMPLE / DOBLE	65,00

Accesorios para grupos de presión - Grifo Aforo Presostato

87	Pág Catálogo	Código	Modelo	P.V.P. Euros
		2205	GRIFO AFORO PRESOSTATO 1/4"	8,00



Accesorios para grupos de presión - Racords 5 Vías

87	Pág Catálogo	Código	Modelo	P.V.P. Euros
		2125	RACORD 1 x 1 x 1 de 91 MM.	16,00
		2124	RACORD VARIADOR 5 VIAS 1" INOX 87 MM.	40,00
		2123	RACORD VARIADOR 5 VIAS 1 1/4" INOX 87 MM.	55,00

Accesorios para grupos de presión - Manómetros

87	Pág Catálogo	Código	Modelo	P.V.P. Euros
		2114	MANÓMETRO 0-6 Kg/cm ² Ø 53	6,50
		2122	MANÓMETRO 0-10 Kg/cm ² Ø 53	6,50
		2121	MANÓMETRO GLICERINA 0-10 Kg/cm ² Ø 63	23,00
		2638	MANÓMETRO GLICERINA 0-16 Kg/cm ² Ø 63	23,00
		2639	MANÓMETRO GLICERINA 0-25 Kg/cm ² Ø 63	23,00

Pequeños grupos de presión automáticos para servicios domésticos

88-89	Pág Catálogo	Código	Modelo	C.V.	P.V.P. Euros
		3502	NIZABOX 43/24 II	0,5	398,00
		3503	NIZABOX 44/24 II	0,75	431,00
		3485	NIZABOX 45/24 II	1	494,00
		3486	NIZABOX 63/24 II	0,8	449,00
		3504	NIZABOX 64/24 II	1	492,00
		3505	NIZABOX 65/24 II	1,3	534,00
		3487	NIZABOX 66/24 II	1,5	575,00
		3017	CENTRIBOX 80/24 II	0,8	646,00
		3019	CENTRIBOX 100/24 II	1	666,00
		3021	CENTRIBOX 150/24 II	1,5	886,00
		3470	CENTRIBOX 75/24 II	0,75	516,00
		3476	CENTRIBOX 95/24 II	1	536,00
		3478	CENTRIBOX 145/24 II	1,5	811,00
		3029	JETBOX 60/24 II	0,8	309,00
		3049	JETBOX 100/24 II	1	313,00
		3088	JETIBOX 80/24 II	0,8	602,00
		3025	JETIBOX 100/24 II	1	621,00
		3030	JETIBOX 100/24 INOX II	1	932,00
		3090	JETIBOX 120/24 II	1,2	667,00
		3560	NIZABOX 43/LOGICPRESS II	0,5	405,00
		3561	NIZABOX 44/LOGICPRESS II	0,75	443,00
		3566	NIZABOX 45/LOGICPRESS II	1	498,00
		3567	NIZABOX 63/LOGICPRESS II	0,8	461,00
		3562	NIZABOX 64/LOGICPRESS II	1	498,00
		3563	NIZABOX 65/LOGICPRESS II	1,3	538,00
		3568	NIZABOX 66/LOGICPRESS II	1,5	594,00
		3580	NIZABOX 43/LOGICPRESS-M II	0,5	413,00
		3581	NIZABOX 44/LOGICPRESS-M II	0,75	459,00
		3586	NIZABOX 45/LOGICPRESS-M II	1	515,00
		3587	NIZABOX 63/LOGICPRESS-M II	0,8	478,00
	3582	NIZABOX 64/LOGICPRESS-M II	1	515,00	
	3583	NIZABOX 65/LOGICPRESS-M II	1,3	556,00	
	3588	NIZABOX 66/LOGICPRESS-M II	1,5	613,00	
		3570	NIZABOX 43/LOGICPRESS-SET II	0,5	426,00
		3571	NIZABOX 44/LOGICPRESS-SET II	0,75	464,00
		3576	NIZABOX 45/LOGICPRESS-SET II	1	520,00
		3577	NIZABOX 63/LOGICPRESS-SET II	0,8	483,00
		3572	NIZABOX 64/LOGICPRESS-SET II	1	520,00
		3573	NIZABOX 65/LOGICPRESS-SET II	1,3	562,00
		3578	NIZABOX 66/LOGICPRESS-SET II	1,5	617,00
		3590	NIZABOX 43/LOGICPRESS-SET" M" II	0,5	445,00
		3591	NIZABOX 44/LOGICPRESS-SET" M" II	0,75	478,00
		3596	NIZABOX 45/LOGICPRESS-SET" M" II	1	537,00
		3597	NIZABOX 63/LOGICPRESS-SET" M" II	0,8	501,00
		3592	NIZABOX 64/LOGICPRESS-SET" M" II	1	537,00
		3593	NIZABOX 65/LOGICPRESS-SET" M" II	1,3	577,00
		3598	NIZABOX 66/LOGICPRESS-SET" M" II	1,5	633,00

Pequeños grupos de presión automáticos para servicios domésticos

88-89	Pág Catálogo	Código	Modelo	C.V.	P.V.P. Euros
		3565	JETBOX 100/LOGICPRESS II	1	307,00
		3585	JETBOX 100/LOGICPRESS-M II	1	324,00
		3575	JETBOX 100/LOGICPRESS-SET II	1	333,00
		3595	JETBOX 100/LOGICPRESS-SET" M" II	1	351,00
		3508	NIZABOX 43/PRESSCONTROL II	0,5	425,00
		3509	NIZABOX 44/PRESSCONTROL II	0,75	462,00
		3530	NIZABOX 45/PRESSCONTROL II	1	518,00
		3531	NIZABOX 63/PRESSCONTROL II	0,8	482,00
		3510	NIZABOX 64/PRESSCONTROL II	1	518,00
		3511	NIZABOX 65/PRESSCONTROL II	1,3	560,00
		3532	NIZABOX 66/PRESSCONTROL II	1,5	616,00
		3942	CENTRIBOX 80/PRESSCONTROL II	0,8	643,00
		3944	CENTRIBOX 100/PRESSCONTROL II	1	664,00
		3946	CENTRIBOX 150/PRESSCONTROL II	1,5	886,00
		3955	CENTRIBOX 75/PRESSCONTROL II	0,75	513,00
		3957	CENTRIBOX 95/PRESSCONTROL II	1	533,00
		3958	CENTRIBOX 145/PRESSCONTROL II	1,5	811,00
		3959	JETBOX 60/PRESSCONTROL II	0,8	321,00
		3966	JETBOX 100/PRESSCONTROL II	1	327,00
		3961	JETIBOX 80/PRESSCONTROL II	0,8	599,00
		3960	JETIBOX 100/PRESSCONTROL II	1	618,00
		3962	JETIBOX 120/PRESSCONTROL II	1,2	665,00
		3514	NIZABOX 43/ECOPRESS II	0,5	391,00
		3515	NIZABOX 44/ECOPRESS II	0,75	426,00
		3518	NIZABOX 45/ECOPRESS II	1	482,00
		3519	NIZABOX 63/ECOPRESS II	0,8	446,00
		3516	NIZABOX 64/ECOPRESS II	1	482,00
		3891	CENTRIBOX 80/ECOPRESS II	0,8	584,00
		3892	CENTRIBOX 100/ECOPRESS II	1	606,00
		3895	JETBOX 60/ECOPRESS II	0,8	301,00
		3896	JETBOX 100/ECOPRESS II	1	307,00
		3897	JETIBOX 80/ECOPRESS II	0,8	540,00
		3894	JETIBOX 100/ECOPRESS II	1	560,00
		3917	CENTRIBOX 80/RP II	0,8	647,00
		3919	CENTRIBOX 100/RP II	1	668,00
		3921	CENTRIBOX 150/RP II	1,5	890,00
		3923	JETBOX 60/RP II	0,8	351,00
		3924	JETBOX 100/RP II	1	356,00



Grupos de presión automáticos ejecución con bomba horizontal multicelular trifásica

91	Pág. Catálogo	Código	Modelo	C.V.	P.V.P. Euros.
			• GRUPOS SIMPLES BOMBA NIZA		
			GS-NIZA 6.4 T (Completo sin acumulador)	1	1.029,00
			GS-NIZA 6.5 T	1,3	1.046,00
			GS-NIZA 6.6 T	1,5	1.096,00
			GS-NIZA 10.3 T	1	1.158,00
			GS-NIZA 10.4 T	1,5	1.189,00
			GS-NIZA 10.5 T	2	1.219,00
			GS-NIZA 10.6 T	3	1.305,00
			• GRUPOS DOBLES BOMBA NIZA		
			GDB-NIZA 6.4 T (Completo sin acumulador)	1+1	1.853,00
			GDB-NIZA 6.5 T	1,3+1,3	1.888,00
			GDB-NIZA 6.6 T	1,5+1,5	1.987,00
			GDB-NIZA 10.3 T	1+1	2.147,00
			GDB-NIZA 10.4 T	1,5+1,5	2.208,00
		GDB-NIZA 10.5 T	2+2	2.269,00	
		GDB-NIZA 10.6 T	3+3	2.441,00	
		* Grupos Dobles con Relé de Alternancia, incluido en el precio			

* Para grupos no especificados, rogamos consulten con nuestro departamento técnico.

Grupos de presión automáticos ejecución con bomba vertical trifásica

91	Continuación	Código	Modelo	C.V.	P.V.P. Euros.
			• GRUPOS SIMPLES BOMBA ROMA		
			GS-ROMA 5.4 T (Completo sin acumulador)	1	1.040,00
			GS-ROMA 5.5 T	1,3	1.058,00
			GS-ROMA 5.6 T	1,5	1.110,00
			GS-ROMA 9.3 T	1	1.148,00
			GS-ROMA 9.4 T	1,5	1.178,00
			GS-ROMA 9.5 T	2	1.209,00
			GS-ROMA 9.6 T	3	1.315,00
			GS-ROMA 9.7 T	3,5	1.354,00
			GS-ROMA 9.8 T	4	1.390,00
			GS-ROMA 11.8 T	4	1.628,00
			GS-ROMA 11.10 T	5,5	1.777,00
			GS-ROMA 21.4 T	3	1.403,00
			GS-ROMA 21.6 T	4	1.617,00
		GS-ROMA 21.7 T	5,5	1.745,00	

Grupos de presión automáticos ejecución con bomba vertical trifásica

91	Continuación	Código	Modelo	C.V.	P.V.P. Euros.
	• GRUPOS DOBLES BOMBA ROMA				
			GDB-ROMA 5.4 T (Completo sin acumulador)	1+1	1.858,00
			GDB-ROMA 5.5 T	1,3+1,3	1.894,00
			GDB-ROMA 5.6 T	1,5+1,5	2.017,00
			GDB-ROMA 9.3 T	1+1	2.092,00
			GDB-ROMA 9.4 T	1,5+1,5	2.153,00
			GDB-ROMA 9.5 T	2+2	2.215,00
			GDB-ROMA 9.6 T	3+3	2.428,00
			GDB-ROMA 9.7 T	3,5+3,5	2.504,00
			GDB-ROMA 9.8 T	4+4	2.577,00
			GDB-ROMA 11.8 T	4+4	3.052,00
			GDB-ROMA 11.10 T	5,5+5,5	3.340,00
			GDB-ROMA 21.4 T	3+3	2.602,00
			GDB-ROMA 21.6 T	4+4	3.030,00
			GDB-ROMA 21.7 T	5,5+5,5	3.287,00
* Grupos Dobles con Relé de Alternancia, incluido en el precio					

* Para grupos no especificados, rogamos consulten con nuestro departamento técnico.

Grupos de presión compactos de alta eficiencia con variador de frecuencia

Pág. Catálogo	Código	Modelo	C.V.	P.V.P. Euros.
	Serie GDAF			Consultar

Grupos de presión con variador de velocidad con bomba multicelular Serie iSmartVar

92	Pág. Catálogo	Código	Modelo	C.V.	P.V.P. Euros.
	Serie GSSVAR/GDSVAR			Consultar	

* Para grupos no especificados, rogamos consulten con nuestro departamento técnico.

Grupos de presión con variador de velocidad con bomba horizontal Serie Speedbox

93	Pág. Catálogo	Código	Modelo	C.V.	P.V.P. Euros.
	• GRUPOS SIMPLES				
			GSSBOX-NIZA 6.5 MT	1,3	1.914,00
			GSSBOX-NIZA 6.5 TT	1,3	2.053,00
			GSSBOX-NIZA 10.5 MT	2	2.087,00
			GSSBOX-NIZA 10.5 TT	2	2.226,00

Grupos de presión con variador de velocidad con bomba horizontal Serie Speedbox

93	Pág. Catálogo	Código	Modelo	C.V.	P.V.P. Euros.
		• GRUPOS DOBLES			
			GDSBOXALT-NIZA 4.5 MT	1+1	3.544,00
			GDSBOXALT-NIZA 4.5 TT	1+1	3.821,00
			GDSBOXALT-NIZA 6.3 MT	0,8+0,8	3.471,00
			GDSBOXALT-NIZA 6.3 TT	0,8+0,8	3.749,00
			GDSBOXALT-NIZA 6.4 MT	1+1	3.544,00
			GDSBOXALT-NIZA 6.4 TT	1+1	3.821,00
			GDSBOXALT-NIZA 6.5 MT	1,3+1,3	3.579,00
			GDSBOXALT-NIZA 6.5 TT	1,3+1,3	3.857,00
			GDSBOXALT-NIZA 6.6 MT	1,5+1,5	3.678,00
			GDSBOXALT-NIZA 6.6 TT	1,5+1,5	3.956,00
			GDSBOXALT-NIZA 10.3 MT	1+1	3.838,00
			GDSBOXALT-NIZA 10.3 TT	1+1	4.116,00
			GDSBOXALT-NIZA 10.4 MT	1,5+1,5	3.900,00
			GDSBOXALT-NIZA 10.4 TT	1,5+1,5	4.177,00
			GDSBOXALT-NIZA 10.5 MT	2+2	3.960,00
			GDSBOXALT-NIZA 10.5 TT	2+2	4.238,00
			GDSBOXALT-NIZA 10.6 MT	3+3	4.132,00
	GDSBOXALT-NIZA 10.6 TT	3+3	4.410,00		

* Para grupos no especificados, rogamos consulten con nuestro departamento técnico.

Grupos de presión con variador de velocidad con bomba vertical Serie Speedbox

93	Continuación	Código	Modelo	C.V.	P.V.P. Euros.	
		• GRUPOS SIMPLES				
			GSSBOX-ROMA 5.6 MT	1,5	1.950,00	
			GSSBOX-ROMA 5.6 TT	1,5	2.089,00	
			GSSBOX-ROMA 9.6 MT	3	2.183,00	
			GSSBOX-ROMA 9.6 TT	3	2.322,00	
			GSSBOX-ROMA 11.8 TT	4	2.749,00	
			GSSBOX-VS 4.8 TT	2	3.874,00	
			GSSBOX-VS 8.8 TT	4	4.954,00	
			GSSBOX-VS 16.6 TT	7,5	6.536,00	
			• GRUPOS DOBLES			
			GDSBOXALT-ROMA 5.4 MT	1+1	3.531,00	
			GDSBOXALT-ROMA 5.4 TT	1+1	3.808,00	
			GDSBOXALT-ROMA 5.5 MT	1,3+1,3	3.567,00	
			GDSBOXALT-ROMA 5.5 TT	1,3+1,3	3.844,00	
			GDSBOXALT-ROMA 5.6 MT	1,5+1,5	3.671,00	
			GDSBOXALT-ROMA 5.6 TT	1,5+1,5	3.949,00	
			GDSBOXALT-ROMA 9.3 MT	1+1	3.783,00	
			GDSBOXALT-ROMA 9.3 TT	1+1	4.061,00	

Grupos de presión con variador de velocidad con bomba vertical Serie Speedbox

93	Continuación	Código	Modelo	C.V.	P.V.P. Euros.
			GDSBOXALT-ROMA 9.4 MT	1,5+1,5	3.844,00
			GDSBOXALT-ROMA 9.4 TT	1,5+1,5	4.122,00
			GDSBOXALT-ROMA 9.5 MT	2+2	3.906,00
			GDSBOXALT-ROMA 9.5 TT	2+2	4.183,00
			GDSBOXALT-ROMA 9.6 MT	3+3	4.119,00
			GDSBOXALT-ROMA 9.6 TT	3+3	4.397,00
			GDSBOXALT-ROMA 9.7 MT	3,5+3,5	4.195,00
			GDSBOXALT-ROMA 9.7 TT	3,5+3,5	4.702,00
			GDSBOXALT-ROMA 9.8 TT	4+4	4.775,00
			GDSBOXALT-ROMA 11.4 MT	1,5+1,5	4.149,00
			GDSBOXALT-ROMA 11.4 TT	1,5+1,5	4.426,00
			GDSBOXALT-ROMA 11.5 MT	2+2	4.275,00
			GDSBOXALT-ROMA 11.5 TT	2+2	4.553,00
			GDSBOXALT-ROMA 11.6 MT	3+3	4.306,00
			GDSBOXALT-ROMA 11.6 TT	3+3	4.584,00
			GDSBOXALT-ROMA 11.8 TT	4+4	5.330,00
			GDSBOXALT-ROMA 11.10 TT	5,5+5,5	5.797,00
			GDSBOXALT-ROMA 21.4 MT	3+3	4.293,00
			GDSBOXALT-ROMA 21.4 TT	3+3	4.800,00
			GDSBOXALT-ROMA 21.6 TT	4+4	5.307,00
			GDSBOXALT-ROMA 21.7 TT	5,5+5,5	5.564,00
			GDSBOXALT-VS 4.8 TT	2+2	7.533,00
			GDSBOXALT-VS 8.8 TT	4+4	9.672,00
			GDSBOXALT-VS 16.6 TT	7,5+7,5	12.746,00

Grupos de presión con variador de frecuencia Serie Speedboard

94	Pág. Catálogo	Código	Modelo	C.V.	P.V.P. Euros.
			• GRUPOS DOMESTICOS BOMBA NIZA		
			NIZASPEED 45 MT	1	1.454,00
			NIZASPEED 63 MT	0,8	1.417,00
			NIZASPEED 64 MT	1	1.454,00
			NIZASPEED 65 MT	1,3	1.472,00
			NIZASPEED 66 MT	1,5	1.522,00
			NIZASPEED 103 MT	1	1.567,00
			NIZASPEED 103 TT	1	1.738,00
			NIZASPEED 104 MT	1,5	1.598,00
			NIZASPEED 104 TT	1,5	1.769,00
			NIZASPEED 105 MT	2	1.628,00
			NIZASPEED 105 TT	2	1.800,00
			NIZASPEED 106 MT	3	1.716,00
			NIZASPEED 106 TT	3	1.887,00

Grupos de presión con variador de frecuencia Serie Speedboard

94	Pág. Catálogo	Código	Modelo	C.V.	P.V.P. Euros.
			• GRUPOS SIMPLES BOMBA NIZA		
			GSSB-NIZA 6.4 MT	1	1.761,00
			GSSB-NIZA 6.4 TT	1	1.930,00
			GSSB-NIZA 6.5 MT	1,3	1.778,00
			GSSB-NIZA 6.5 TT	1,3	1.947,00
			GSSB-NIZA 6.6 MT	1,5	1.828,00
			GSSB-NIZA 6.6 TT	1,5	1.997,00
			GSSB-NIZA 10.3 MT	1	1.890,00
			GSSB-NIZA 10.3 TT	1	2.059,00
			GSSB-NIZA 10.4 MT	1,5	1.921,00
			GSSB-NIZA 10.4 TT	1,5	2.090,00
			GSSB-NIZA 10.5 MT	2	1.951,00
			GSSB-NIZA 10.5 TT	2	2.120,00
			GSSB-NIZA 10.6 MT	3	2.037,00
			GSSB-NIZA 10.6 TT	3	2.206,00
			• GRUPOS DOBLES BOMBA NIZA		
			GDSBALT-NIZA 6.4 MT	1+1	3.338,00
			GDSBALT-NIZA 6.4 TT	1+1	3.676,00
			GDSBALT-NIZA 6.5 MT	1,3+1,3	3.374,00
			GDSBALT-NIZA 6.5 TT	1,3+1,3	3.711,00
			GDSBALT-NIZA 6.6 MT	1,5+1,5	3.473,00
			GDSBALT-NIZA 6.6 TT	1,5+1,5	3.811,00
			GDSBALT-NIZA 10.3 MT	1+1	3.599,00
			GDSBALT-NIZA 10.3 TT	1+1	3.937,00
			GDSBALT-NIZA 10.4 MT	1,5+1,5	3.661,00
			GDSBALT-NIZA 10.4 TT	1,5+1,5	3.998,00
			GDSBALT-NIZA 10.5 MT	2+2	3.721,00
			GDSBALT-NIZA 10.5 TT	2+2	4.059,00
		GDSBALT-NIZA 10.6 MT	3+3	3.893,00	
		GDSBALT-NIZA 10.6 TT	3+3	4.231,00	

Grupos de presión con variador de frecuencia Serie Speedboard

94	Pág. Catálogo	Código	Modelo	C.V.	P.V.P. Euros.
			• GRUPOS SIMPLES BOMBA ROMA		
			GSSB-ROMA 5.4 MT	1	1.754,00
			GSSB-ROMA 5.4 TT	1	1.923,00
			GSSB-ROMA 5.5 MT	1,3	1.772,00
			GSSB-ROMA 5.5 TT	1,3	1.941,00
			GSSB-ROMA 5.6 MT	1,5	1.824,00
			GSSB-ROMA 5.6 TT	1,5	1.993,00
			GSSB-ROMA 9.3 MT	1	1.880,00
		GSSB-ROMA 9.3 TT	1	2.049,00	

Grupos de presión con variador de frecuencia Serie Speedboard

94	Pág. Catálogo	Código	Modelo	C.V.	P.V.P. Euros.
			GSSB-ROMA 9.4 MT	1,5	1.910,00
			GSSB-ROMA 9.4 TT	1,5	2.079,00
			GSSB-ROMA 9.5 MT	2	1.941,00
			GSSB-ROMA 9.5 TT	2	2.110,00
			GSSB-ROMA 9.6 MT	3	2.047,00
			GSSB-ROMA 9.6 TT	3	2.216,00
			GSSB-ROMA 9.7 MT	3,5	2.086,00
			GSSB-ROMA 9.7 TT	3,5	2.330,00
			GSSB-ROMA 9.8 TT	4	2.367,00
			GSSB-ROMA 11.8 TT	4	2.604,00
			GSSB-ROMA 11.10 TT	5,5	2.788,00
			GSSB-ROMA 21.4 MT	3	2.135,00
			GSSB-ROMA 21.4 TT	3	2.379,00
			GSSB-ROMA 21.6 TT	4	2.593,00
			GSSB-ROMA 21.7 TT	5,5	2.722,00
			• GRUPOS DOBLES BOMBA ROMA		
			GDSBALT-ROMA 5.4 MT	1+1	3.325,00
			GDSBALT-ROMA 5.4 TT	1+1	3.663,00
			GDSBALT-ROMA 5.5 MT	1,3+1,3	3.361,00
			GDSBALT-ROMA 5.5 TT	1,3+1,3	3.699,00
			GDSBALT-ROMA 5.6 MT	1,5+1,5	3.466,00
			GDSBALT-ROMA 5.6 TT	1,5+1,5	3.804,00
			GDSBALT-ROMA 9.3 MT	1+1	3.578,00
			GDSBALT-ROMA 9.3 TT	1+1	3.916,00
			GDSBALT-ROMA 9.4 MT	1,5+1,5	3.639,00
			GDSBALT-ROMA 9.4 TT	1,5+1,5	3.977,00
			GDSBALT-ROMA 9.5 MT	2+2	3.701,00
			GDSBALT-ROMA 9.5 TT	2+2	4.038,00
			GDSBALT-ROMA 9.6 MT	3+3	3.914,00
			GDSBALT-ROMA 9.6 TT	3+3	4.251,00
			GDSBALT-ROMA 9.7 MT	3,5+3,5	3.990,00
			GDSBALT-ROMA 9.7 TT	3,5+3,5	4.479,00
			GDSBALT-ROMA 9.8 TT	4+4	4.552,00
			GDSBALT-ROMA 11.8 TT	4+4	5.028,00
			GDSBALT-ROMA 11.10 TT	5,5+5,5	5.630,00
			GDSBALT-ROMA 21.4 MT	3+3	4.088,00
			GDSBALT-ROMA 21.4 TT	3+3	4.426,00
			GDSBALT-ROMA 21.6 TT	4+4	5.005,00
			GDSBALT-ROMA 21.7 TT	5,5+5,5	5.262,00



Grupos de presión con variador de frecuencia ejecución con bomba horizontal trifásica

95	Pág. Catálogo	Código	Modelo	C.V.	P.V.P. Euros.
	• GRUPOS DOBLES BOMBA NIZA				
			GDVF-NIZA 6.4 T	1+1	4.730,00
			GDVF-NIZA 6.5 T	1,3+1,3	4.765,00
			GDVF-NIZA 6.6 T	1,5+1,5	4.864,00
			GDVF-NIZA 10.3 T	1+1	4.929,00
			GDVF-NIZA 10.4 T	1,5+1,5	4.991,00
			GDVF-NIZA 10.5 T	2+2	5.299,00
			GDVF-NIZA 10.6 T	3+3	5.587,00

* Para grupos no especificados, rogamos consulten con nuestro departamento técnico.

Grupos de presión con variador de frecuencia ejecución con bomba vertical trifásica

95	Pág. Catálogo	Código	Modelo	C.V.	P.V.P. Euros.
	• GRUPOS DOBLES BOMBA ROMA				
			GDVF-ROMA 5.4 T	1+1	4.743,00
			GDVF-ROMA 5.5 T	1,3+1,3	4.779,00
			GDVF-ROMA 5.6 T	1,5+1,5	4.884,00
			GDVF-ROMA 9.3 T	1+1	4.949,00
			GDVF-ROMA 9.4 T	1,5+1,5	5.009,00
			GDVF-ROMA 9.5 T	2+2	5.319,00
			GDVF-ROMA 9.6 T	3+3	5.648,00
			GDVF-ROMA 9.7 T	3,5+3,5	5.789,00
			GDVF-ROMA 9.8 T	4+4	6.021,00
			GDVF-ROMA 11.8 T	4+4	6.497,00
			GDVF-ROMA 11.10 T	5,5+5,5	7.274,00
			GDVF-ROMA 21.4 T	3+3	5.823,00
			GDVF-ROMA 21.6 T	4+4	6.795,00
		GDVF-ROMA 21.7 T	5,5+5,5	7.051,00	

* Para grupos no especificados, rogamos consulten con nuestro departamento técnico.

Grupos de presión contra incendios según normativa UNE-23.500:2021

98-99	Pág. Catálogo	Código	Modelo	P.V.P. Euros.
			UNE 21 EJ 12/45	Consultar
			UNE 21 EJ 12/50	Consultar
			UNE 21 EJ 12/55	Consultar
			UNE 21 EJ 12/60	Consultar
			UNE 21 EJ 12/65	Consultar
			UNE 21 EJ 12/70	Consultar
			UNE 21 EJ 12/75	Consultar
			UNE 21 EJ 12/80	Consultar
			UNE 21 EJ 12/85	Consultar
			UNE 21 EJ 12/90	Consultar
			UNE 21 EJ 12/95	Consultar

Grupos de presión contra incendios

98-99	Pág. Catálogo	Código	Modelo	P.V.P. Euros.
				Consultar

PARA OTRAS EJECUCIONES Y NORMATIVAS

Colectores de pruebas + Rotámetro de inserción

98	Pág Catálogo	Código	Modelo	P.V.P. Euros
		6500	COLECTOR DE PRUEBAS + ROTÁMETRO DN-50	444,00
		6501	COLECTOR DE PRUEBAS + ROTÁMETRO DN-65	525,00
		6502	COLECTOR DE PRUEBAS + ROTÁMETRO DN-80	882,00
		6503	COLECTOR DE PRUEBAS + ROTÁMETRO DN-100	1.100,00
		6504	COLECTOR DE PRUEBAS + ROTÁMETRO DN-125	1.666,00
		6505	COLECTOR DE PRUEBAS + ROTÁMETRO DN-150	2.067,00
		6506	COLECTOR DE PRUEBAS + ROTÁMETRO DN-200	2.264,00
		6300	ROTÁMETRO INSERCIÓN DE 2"	309,00
		6301	ROTÁMETRO INSERCIÓN DE 2 1/2"	345,00
		6302	ROTÁMETRO INSERCIÓN DE 3"	538,00
		6303	ROTÁMETRO INSERCIÓN DE 4"	615,00
		6306	ROTÁMETRO INSERCIÓN DE 5"	747,00
		6304	ROTÁMETRO INSERCIÓN DE 6"	796,00
		6305	ROTÁMETRO INSERCIÓN DE 8"	872,00

Electrobombas sumergibles para drenajes Serie Mopa

100	Pág Catálogo	Código	Modelo	C.V.	P.V.P. Euros
		1209	MOPA 3500 AUT	0,5	116,00

Electrobombas sumergibles de doble función para achique Serie Duplex

101	Pág Catálogo	Código	Modelo	C.V.	P.V.P. Euros
		1222	DUPLEX 100 AUT	1	170,00

Electrobombas sumergibles para achique y aguas residuales Serie Turbo

102	Pág Catálogo	Código	Modelo	C.V.	P.V.P. Euros
		1389	TURBO 55	0,5	147,00
		1428	TURBO 100 D	1	181,00

Electrobombas sumergibles para drenaje Serie Drinox

103	Pág Catálogo	Código	Modelo	C.V.	P.V.P. Euros
		1507	DRINOX - 1A	0,8	417,00
		1508	DRINOX - 2A	1,2	540,00
		2182	SUPLEMENTO INTERRUPTOR DE NIVEL VERTICAL		90,00

Electrobombas sumergibles para aguas cargadas Serie Inox-Palm

104-105	Pág Catálogo	Código	Modelo	C.V.	P.V.P. Euros
		1228	INOX-PALM 1A	0,8	421,00
		1227	INOX-PALM 2A	1,2	548,00
		1210	INOX-PALM 2	1,2	540,00
		1692	INOX-PALM 2.5A	1,5	744,00
		1693	INOX-PALM 2.5	1,5	736,00
		1694	INOX-PALM 3A	1,5	879,00
		1695	INOX-PALM 3	1,5	851,00
		1696	INOX-PALM 4A	2	1.096,00
		1697	INOX-PALM 4	2	920,00
		1698	INOX-PALM 5	3	1.121,00
		1686	INOX-PALM 6A	1,5	978,00
		1687	INOX-PALM 6	1,5	953,00
		1688	INOX-PALM 7A	2	1.199,00
		1689	INOX-PALM 7	2	1.023,00
		1690	INOX-PALM 8	3	1.223,00
	1691	INOX-PALM 9	4	1.391,00	
	2182	SUPLEMENTO INTERRUPTOR DE NIVEL VERTICAL		90,00	

Electrobombas sumergibles para achique aguas cargadas Serie IPX

106	Pág Catálogo	Código	Modelo	C.V.	P.V.P. Euros
		7070	IPX - 1A	0,8	511,00
		7071	IPX - 2A	1,2	601,00
		7069	IPX - 2	1,2	593,00
		7067	IPX - 2.5A	1,5	856,00
		7068	IPX - 2.5	1,5	847,00
		7072	IPX - 3A	1,5	1.014,00
		7073	IPX - 3	1,5	994,00
		7074	IPX - 4A	2	1.231,00
		7075	IPX - 4	2	1.076,00
		7076	IPX - 5	3	1.280,00
	2182	SUPLEMENTO INTERRUPTOR DE NIVEL VERTICAL		90,00	

Electrobombas sumergibles para aguas cargadas Serie Minipaf

107	Pág Catálogo	Código	Modelo	C.V.	P.V.P. Euros
		1570	MINIPAF-4	0,5	380,00
		1571	MINIPAFM-4 AUT.	0,5	386,00
		1302	MINIPAF-7	0,75	574,00
		1300	MINIPAFM-7 AUT.	0,75	609,00
		1303	MINIPAF-10	1	644,00
		1305	MINIPAFM-10 AUT.	1	680,00
		1572	MINIPAF-4 D	0,5	380,00
		1573	MINIPAFM-4 D AUT.	0,5	386,00
		1310	MINIPAF-7 D	0,75	574,00
		1312	MINIPAFM-7 D AUT.	0,75	609,00
		1311	MINIPAF-10 D	1	644,00
		1314	MINIPAFM-10 D AUT.	1	680,00
		1396	MINIPAF-15 D	1,5	823,00
		1397	MINIPAFM-15 D AUT.	1,5	894,00

Electrobombas sumergibles para aguas residuales Serie PAF

108	Pág Catálogo	Código	Modelo	C.V.	P.V.P. Euros
		1306	PAF-12	1,5	1.216,00
		1307	PAFM-12 AUT.	1,5	1.303,00
		1308	PAF-13	2	1.287,00
		1320	PAFM-13 AUT.	2	1.389,00
		1309	PAF-14	3	1.545,00
		1315	PAF-12 D	1,5	1.216,00
		1316	PAFM-12 D AUT.	1,5	1.303,00
		1317	PAF-13 D	2	1.287,00
		1321	PAFM-13 D AUT.	2	1.389,00
		1318	PAF-14 D	3	1.545,00

Electrobombas sumergibles para aguas residuales Serie PAF20

109	Pág Catálogo	Código	Modelo	C.V.	P.V.P. Euros
		1555	PAFM-20 D	1,5	2.252,00
		1556	PAF -20 D	1,5	2.214,00
		1557	PAFM-21 D	2	2.261,00
		1558	PAF -21 D	2	2.217,00
		1559	PAF -22 D	3	2.233,00
		1560	PAF -23 D	4	3.018,00
		1561	PAF -24 D	5,5	3.059,00
		1562	PAF -25 D	10	4.247,00

Electrobombas sumergibles para aguas residuales Serie SRI

110	Pág Catálogo	Código	Modelo	C.V.	P.V.P. Euros
		7375	SRI - 05 Aut.	0,5	1.861,00
		7373	SRI - 05	0,5	1.832,00
		7376	SRI - 1 Aut.	1	2.033,00
		7374	SRI - 1	1	2.004,00
		7377	SRI - 2	2	4.185,00
		7378	SRI - 3	3	4.558,00
		7379	SRI - 5	5	6.337,00

Electrobombas sumergibles para aguas residuales Serie AT-VT a 1.450 r.p.m.

111-113	Pág Catálogo	Código	Modelo	C.V.	P.V.P. Euros
		7025	AM 80/4/125 C.242	2	4.482,00
		7026	AT 80/4/125 C.242	2	3.253,00
		7028	AT 80/4/152 C.244	3	4.065,00
		7029	AT 80/4/152 C.245	4	4.541,00
		7030	AT 100/4/152 C.243	2	3.952,00
		7031	AT 100/4/152 C.244	3	4.470,00
		7032	AT 100/4/152 C.245	4	4.991,00
		7033	AT 100/4/173 C.255	5,5	6.887,00
		7034	AT 100/4/173 C.256	7,5	8.079,00
		7035	AT 150/4/173 C.258	10	12.208,00
		7062	AT 150/4/200 C.260	13,5	13.459,00
		7063	AT 150/4/200 C.263	22,5	15.113,00
		7036	AT 150/4/200 C.264	16	16.167,00
		7037	AT 150/4/200 C.265	22	21.656,00
		7038	AT 150/4/240 C.275	24	26.271,00
		7039	AT 150/4/240 C.280	31	30.503,00
		7040	AT 150/4/340 C.285	40	37.020,00
		7041	AT 150/4/340 C.290	54	45.849,00
		7042	AT 150/4/340 C.295	61	53.316,00
		7023	AT 150/4/340 C.300	68	55.069,00
		7043	VM 80/4/125 C.341	1,5	4.196,00
		7044	VT 80/4/125 C.341	1,7	3.010,00
		7045	VM 80/4/125 C.342	1,5	4.482,00
		7046	VT 80/4/125 C.342	1,7	3.253,00
		7048	VT 80/4/152 C.344	3	4.065,00
		7049	VT 80/4/152 C.345	4	4.541,00
		7027	VT 100/4/152 C.348	2,3	3.952,00
		7050	VT 100/4/152 C.349	3	4.470,00
		7051	VT 100/4/152 C.350	4	4.991,00

Electrobombas sumergibles para aguas residuales Serie AT-VT a 1.450 r.p.m.

111-113 Pág Catálogo	Código	Modelo	C.V.	P.V.P. Euros
	7052	VT 100/4/173 C.355	5,5	6.887,00
	7053	VT 100/4/173 C.356	8	8.079,00
	7054	VT 100/4/173 C.358	10	9.321,00
	7055	VT 100/4/200 C.362	16	12.840,00
	7056	VT 100/4/200 C.363	21	14.413,00
	7059	VT 150/4/340 C.385	48	37.020,00
	7060	VT 150/4/340 C.390	61	45.849,00
	7061	VT 150/4/340 C.395	75	53.316,00

Electrobombas sumergibles para aguas residuales Serie AT-VT a 2.900 r.p.m.

111-113 Pág Catálogo	Código	Modelo	C.V.	P.V.P. Euros
	7000	AM 65/2/125 C. 236	2	3.872,00
	7001	AT 65/2/125 C. 236	2	2.629,00
	7002	AT 65/2/125 C.237	3	3.102,00
	7005	AT 65/2/152 C.246	4	4.345,00
	7003	AT 65/2/152 C.247	5,5	5.732,00
	7006	AT 80/2/152 C.246	4	5.074,00
	7064	AT 80/2/152 C.247	5,5	6.483,00
	7014	AT 80/2/173 C.254	7,5	7.290,00
	7004	AT 80/2/173 C.257	10	8.476,00
	7015	AT 80/2/173 C.259	12	9.824,00
	7007	VM 65/2/125 C.336	2	3.872,00
	7008	VT 65/2/125 C.336	2	2.629,00
	7009	VT 65/2/125 C.337	3	3.102,00
	7010	VT 65/2/152 C.346	4	4.345,00
	7011	VT 65/2/152 C.347	5,5	5.732,00
	7065	VT 80/2/152 C.346	4,3	5.074,00
	7066	VT 80/2/152 C.347	5,7	6.483,00
	7012	VT 80/2/173 C.354	7	7.290,00
	7013	VT 80/2/173 C.357	10	8.476,00
	7016	HM 50/2/125 C.500	2	3.932,00
	7017	HT 50/2/125 C.500	2	3.010,00
	7018	HT 50/2/125 C.501	3	3.253,00
	7019	HT 65/2/152 C.502	4	4.345,00
	7020	HT 65/2/152 C.503	5,5	5.732,00
	7021	HT 65/2/173 C.504	7,5	7.226,00
7022	HT 65/2/173 C.505	10	7.872,00	

Electrobombas sumergibles para aguas residuales Serie AT-VT a 2.900 r.p.m.

111-113	Pág Catálogo	Código	Modelo	C.V.	P.V.P. Euros
			ATH 80/2/120	16	Consultar
			ATH 80/2/150	20	Consultar
			ATH 80/2/200	27	Consultar
			ATH 80/2/250	34	Consultar
			ATH 80/2/300	41	Consultar
			ATH 100/2/120	16	Consultar
			ATH 100/2/150	20	Consultar
			ATH 100/2/200	27	Consultar
			ATH 100/2/250	34	Consultar
			ATH 100/2/350	48	Consultar
			ATH 100/2/400	54	Consultar
			ATH 100/2/420	57	Consultar
			VTH 80/2/120	16	Consultar
			VTH 80/2/150	20	Consultar
			VTH 80/2/200	27	Consultar
			VTH 80/2/250	33	Consultar
			VTH 100/2/150	20	Consultar
			VTH 100/2/200	27	Consultar
			VTH 100/2/250	34	Consultar
			VTH 100/2/300	41	Consultar
			VTH 100/2/350	48	Consultar
			VTH 100/2/400	54	Consultar
			VTH 100/2/400-1	54	Consultar
			VTH 100/2/400-2	54	Consultar

Accesorios para instalaciones de aguas residuales - Trampillas

114	Pág Catálogo	Código	Modelo	P.V.P. Euros
		2640	TRAMPILLA SIFÓNICA GALVANIZADA 900 X 450 MM	1.353,00
		2641	TRAMPILLA SIFÓNICA GALVANIZADA 900 X 550 MM	1.417,00
		2642	TRAMPILLA SIFÓNICA GALVANIZADA 800 X 600 MM	1.446,00
		2643	TRAMPILLA SIFÓNICA GALVANIZADA 900 X 700 MM	1.453,00
		2644	TRAMPILLA SIFÓNICA GALVANIZADA 1000 X 800 MM	1.811,00
		2645	TRAMPILLA SIFÓNICA GALVANIZADA 1200 X 900 MM	2.104,00

Accesorios para instalaciones aguas residuales - Pie de acoplamiento

114	Pág Catálogo	Código	Modelo	P.V.P. Euros
		2533	PIE DE ACOPLAMIENTO SERIE MINIPAF-PAF 1 1/2"	283,00
		2534	PIE DE ACOPLAMIENTO SERIE MINIPAF-PAF 2"	283,00

Accesorios para instalación fija aguas residuales - Pie de acoplamiento

114	Pág Catálogo	Código	Modelo	P.V.P. Euros
		2535	PIE DE ACOPLAMIENTO TRITURANT - DN 50	809,00
		2542	PIE DE ACOPLAMIENTO PAF / TRITURANT - DN 65	738,00
		2543	PIE DE ACOPLAMIENTO PAF - DN 80	948,00
		2537	PIE DE ACOPLAMIENTO MOD. AT/VT DN 65	702,00
		2538	PIE DE ACOPLAMIENTO MOD. AT/VT DN 80	965,00
		2539	PIE DE ACOPLAMIENTO MOD. AT/VT DN 100	1.285,00
		2540	PIE DE ACOPLAMIENTO B7 - DN 150	2.620,00
		2541	PIE DE ACOPLAMIENTO B8 - DN 150	3.650,00
		2545	KIT PIE DE ACOPLAMIENTO DN 65 - INOX-PALM	153,00

Accesorios para instalación móvil aguas residuales

114	Pág Catálogo	Código	Modelo	P.V.P. Euros	
			KIT CONTRABRIDA CUADRADA DN 65	133,00	
			KIT CONTRABRIDA DN 65	158,00	
			KIT CONTRABRIDA DN 80	163,00	
			KIT CONTRABRIDA DN 100	202,00	
			KIT CONTRABRIDA DN 150	287,00	
				BASE DE APOYO SERIE GT 50/2/125	177,00
				BASE DE APOYO SERIE GT 50/2/152	231,00
				BASE DE APOYO SERIE GT 50/2/173	248,00
				BASE DE APOYO SERIE AT-VT-HT 65	170,00
				BASE DE APOYO SERIE AT-VT 80	215,00
				BASE DE APOYO SERIE AT-VT 100	282,00
				BASE DE APOYO SERIE P7 AT-VT 150	371,00
				BASE DE APOYO SERIE P8 AT-VT 150	520,00
				BASE DE APOYO SERIE AT 200	663,00

Accesorios para instalaciones aguas residuales - Válvulas de retención de Bola

114	Pág Catálogo	Código	Modelo	P.V.P. Euros
		2495	VÁLVULA DE RETENCIÓN DE BOLA EN P.V.C. 1 ¼"	65,00
		2496	VÁLVULA DE RETENCIÓN DE BOLA EN P.V.C. 1 ½"	88,40
		2497	VÁLVULA DE RETENCIÓN DE BOLA EN P.V.C. 2"	125,00
		2498	VÁLVULA DE RETENCIÓN DE BOLA EN P.V.C. 2 ½"	253,00
		2499	VÁLVULA DE RETENCIÓN DE BOLA EN P.V.C. 3"	364,00

Accesorios para instalaciones aguas residuales - Válvulas de cierre de Bola

114	Pág Catálogo	Código	Modelo	P.V.P. Euros
		2490	VÁLVULA DE CIERRE DE BOLA EN P.V.C. 1 ¼"	22,20
		2491	VÁLVULA DE CIERRE DE BOLA EN P.V.C. 1 ½"	28,20
		2492	VÁLVULA DE CIERRE DE BOLA EN P.V.C. 2"	39,10
		2493	VÁLVULA DE CIERRE DE BOLA EN P.V.C. 2 ½"	152,00
		2494	VÁLVULA DE CIERRE DE BOLA EN P.V.C. 3"	189,00

Electrobombas sumergibles para achique y drenaje Serie Supersand

115	Pág. Catálogo	Código	Modelo	C.V.	P.V.P. Euros
		7761	SUPERSAND 200 M	2	3.414,00
		7762	SUPERSAND 200 T	2	3.290,00
		7763	SUPERSAND 300 T	3	3.574,00
		7764	SUPERSAND 500 T	5	4.392,00
		7765	SUPERSAND 750 T	7,5	8.091,00
		7768	SUPERSAND 1000 T	10	8.553,00
		7769	SUPERSAND 2000 T	20	18.580,00
		7766	SUPERSAND AG 300 T	3	5.105,00
		7767	SUPERSAND AG 500 T	5	6.279,00

Electrobombas semisumergibles y de superficie para aguas residuales Serie LFC

116-117	Pág. Catálogo	Modelo	P.V.P. Euros.
		<u>SEMISUMERGIBLES</u>	
		• SERIE SLW (TURBINA ABIERTA)	
		SLW 48-60-80-100 (CAÑA 0,5 A 1,5)	
		SLW 48-60-80-100 (CAÑA 2 A 2,5)	
		• SERIE SFW (TURBINA DESPLAZADA)	
		SFW 48-60-80-100 (CAÑA 0,5 A 1,5)	
		SFW 48-60-80-100 (CAÑA 2 A 2,5)	
		<u>SUPERFICIE</u>	
		•SERIE LH (TURBINA ABIERTA)	
		LH 40-60-80-100	
	•SERIE FH (TURBINA DESPLAZADA)		
	FH 40-60-80-100		

Electrobombas sumergibles para aguas residuales Serie Triturant-130

118	Pág. Catálogo	Código	Modelo	C.V.	P.V.P. Euros
		1796	TRITURANT 130 M	1,2	1.284,00
		1797	TRITURANT 130 T	1,2	1.150,00
		1798	TRITURANT 180 M	1,8	1.463,00
		1799	TRITURANT 180 T	1,8	1.328,00

Electrobombas sumergibles para aguas residuales Serie Triturant

119	Pág. Catálogo	Código	Modelo	C.V.	P.V.P. Euros
		1780	TRITURANT 15 M	1,5	2.861,00
		1781	TRITURANT 15 T	1,5	2.260,00
		1782	TRITURANT 20 M	2	2.875,00
		1783	TRITURANT 20 T	2	2.267,00
		1784	TRITURANT 30 T	3	2.270,00
		1785	TRITURANT 40 T	4	3.540,00
		1786	TRITURANT 55 T	5,5	3.607,00
		1787	TRITURANT 75 T	7,5	4.563,00
		1788	TRITURANT 100 T	10	4.613,00

Equipos de aireación para aguas residuales

120	Pág. Catálogo	Código	Modelo	C.V.	P.V.P. Euros.
		7420	AIR INJECTOR 400	4	3.678,00
		7421	AIR INJECTOR 550	5,5	6.519,00

Equipos de agitación para aguas residuales

121	Pág. Catálogo	Código	Modelo	C.V.	P.V.P. Euros.
		7455	DRX 200-42/110	1,5	5.670,00
		7456	DRX 280-42/250	3,4	8.696,00

Estaciones de bombeo Serie Hasa-Fos 100/2A

122	Pág. Catálogo	Código	Modelo	C.V.	P.V.P. Euros
		4015	HASA-FOS 100/2A	1,2	1.612,00

Estaciones de bombeo Serie Hasa-Fos

123	Pág. Catálogo	Código	Modelo	C.V.	P.V.P. Euros
		4020	HASA-FOS 175/4	0,5	1.805,00
		4022	HASA-FOS 175/7	0,75	2.017,00
		4024	HASA-FOS 175/10	1	2.085,00
		4026	HASA-FOS 175/15	1,5	2.291,00
		4030	HASA-FOS 550/4	0,5+0,5	3.708,00
		4032	HASA-FOS 550/7	0,75+0,75	4.132,00
		4034	HASA-FOS 550/10	1+1	4.268,00
		4036	HASA-FOS 550/15	1,5+1,5	4.678,00

Estaciones de bombeo para aguas residuales

124	Pág. Catálogo	Código	Modelo	P.V.P. Euros.
			ESTACIONES DE BOMBEO	Consultar

Electrobombas autoaspirantes sobre bancada para aguas residuales Serie GTSB

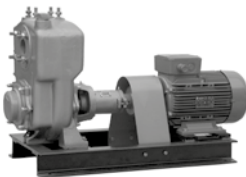
125	Pág. Catálogo	Código	Modelo	C.V.	P.V.P. Euros
		1230	GT-40	1,5	Consultar
		1231	GT-50	3	Consultar
		1232	GT-60	5,5	Consultar
		1233	GT-70	7,5	Consultar
		1234	GT-80	10	Consultar
		1235	GT-90	15	Consultar
		1236	GT-95	20	Consultar

Clarificador estándar de aguas grises Serie Clarificador Estándar

128	Pág. Catálogo	Código	Modelo	P.V.P. Euros
		4050	CLARIFICADOR ESTÁNDAR 250 LTS. (CON CLORACION)	Consultar

Electrobombas autoaspirantes para trasiegos Serie BE

130	Pág. Catálogo	Código	Modelo	C.V.	P.V.P. Euros
		1360	BE-20 M	0,5	189,00
		1368	BE-20 M IP-55	0,5	243,00
		1361	BE-25 M	0,8	242,00
		1369	BE-25 M IP-55	0,6	322,00
		1362	BE-30 M	1	333,00
		1363	BE-30 T	1	493,00
		1364	BE-40 M	1,2	498,00
		1365	BE-40 T	1,2	560,00
		1366	MARINA 20-12	0,5	462,00
		1367	MARINA 20-24	0,5	462,00



Electrobombas autoaspirantes para trasiegos Serie Novax

131	Pág Catálogo	Código	Modelo	C.V.	P.V.P. Euros
		1511	NOVAX 20 M	0,5	273,00
		1512	NOVAX 25 M	0,6	399,00
		1513	NOVAX 30 M	1	553,00
		1514	NOVAX 30 T	1	595,00
		1515	NOVAX 40 M	1,2	656,00
		1516	NOVAX 40 T	1,2	679,00

Accesorios para el trasvase de gas-oil Serie Drill

132	Pág Catálogo	Código	Modelo	P.V.P. Euros
		1354	DRILL-20	98,90

Accesorios para el trasvase de gas-oil

133	Pág Catálogo	Código	Modelo	P.V.P. Euros
  		2171	DIESEL KIT Ø 20	120,00
		2172	DIESEL KIT Ø 25	151,00
		2405	MEDIDOR DE CAUDAL SIN FILTRO	230,00
		2408	PISTOLA PARA GAS-OIL PARO MANUAL	79,60
		2409	PISTOLA PARA GAS-OIL PARO AUTOMATICO	185,00
		2410	5 MTS. MANGUERA IMPULSIÓN ESP. GAS-OIL	148,00
		2451	10 MTS. MANGUERA IMPULSIÓN ESP. GAS-OIL	250,00
		2411	1,5 MTS. MANGUERA ASPIRACIÓN ESP. GAS-OIL	112,00
		2452	2 MTS. MANGUERA ASPIRACIÓN ESP. GAS-OIL	133,00

Electrobombas autoaspirantes para Gas-oil Serie HGM

134	Pág Catálogo	Código	Modelo	C.V.	P.V.P. Euros
		1356	HGM-45	0,5	268,00
		1350	HGT-60 "IP-55"	0,8	509,00
		1351	HGM-60 "IP-55"	0,8	509,00
		1352	HGT-80 "IP-55"	1	512,00
		1353	HGM-80 "IP-55"	1	512,00

Grupos de presión automáticos para Gas-oil Serie GH

135	Pág Catálogo	Código	Modelo	C.V.	P.V.P. Euros
		3698	OILBOX 45/5	0,5	397,00
		3700	OILBOX 60/5	0,8	680,00
		3600	GHSM 60	0,8	1.295,00
		3601	GHSM 45	0,5	998,00
		3606	GHST 60	0,8	1.361,00
		3612	GHSM 80	1	1.297,00
		3618	GHST 80	1	1.363,00
		3630	GHDM 60	2 X 0,8	2.771,00
		3636	GHDT 60	2 X 0,8	2.837,00
		3642	GHDM 80	2 X 1	2.775,00
		3648	GHDT 80	2 X 1	2.841,00

Electrobombas para gas-oil Serie Bag

136	Pág Catálogo	Código	Modelo	C.V.	P.V.P. Euros
		1355	BAG-50	0,5	472,00

Equipos de trasvase para gasoil Serie Bag

137	Pág Catálogo	Código	Modelo	C.V.	P.V.P. Euros
		3706	GRUPO TRASVASE GASOIL BAG-50 ECO	0,5	952,00
		3708	GRUPO TRASVASE GASOIL BAG-50 COM	0,5	1.180,00

Electrobombas de engranajes monobloc Serie W

138	Pág Catálogo	Código	Modelo	C.V.	P.V.P. Euros
		7358	WT-3	0,4	2.399,00
		7359	WM-3	0,4	2.456,00
		7360	WT-5	0,5	2.505,00
		7361	WM-5	0,5	2.558,00
		7362	WT-10	1	2.985,00
		7363	WM-10	1	3.083,00
		7364	WT-16	1	3.116,00
		7365	WM-16	1	3.235,00
		7366	WT-17	2	6.162,00
		7367	WT-25	2	8.069,00
		7368	WT-35	3	8.237,00
		7369	WT-50	4	8.754,00

Electrobombas de engranajes monobloc Serie F

139	Pág Catálogo	Código	Modelo	C.V.	P.V.P. Euros
		1960	F-00/10	0,25	1.305,00
		1961	F-00/11	0,25	1.305,00
		1962	F-00/12	0,25	1.305,00
		1963	F-00/16	0,33	1.385,00
		1964	F-0	0,5	1.503,00
		1965	F-1	1	1.744,00
		1971	F-1-L	1,5	1.956,00
		1966	F-2	2	2.410,00
		1967	F-3	3	2.838,00
		1968	F-4	4	3.158,00
		1969	F-5	7,5	4.805,00
		1970	F-6	10	5.316,00

Electrobombas de refrigeración para máquinas-herramientas Serie ZV

140	Pág Catálogo	Código	Modelo	C.V.	P.V.P. Euros
		7400	ZV-35 LARGO DE 80	0,06	226,00
		7401	ZV-35 LARGO DE 120	0,06	226,00
		7402	ZV-35 LARGO DE 150	0,06	226,00
		7403	ZV-35 LARGO DE 180	0,06	226,00
		7404	ZV-90 LARGO DE 90	0,38	348,00
		7405	ZV-90 LARGO DE 120	0,38	348,00
		7406	ZV-90 LARGO DE 170	0,38	348,00
		7407	ZV-90 LARGO DE 220	0,38	348,00
		7408	ZV-90 LARGO DE 270	0,38	384,00
		7409	ZV-90 LARGO DE 350	0,38	384,00
		7410	ZV-100 LARGO DE 90	0,4	578,00
		7411	ZV-100 LARGO DE 120	0,4	578,00
		7412	ZV-100 LARGO DE 170	0,4	578,00
		7413	ZV-100 LARGO DE 220	0,4	578,00
		7414	ZV-100 LARGO DE 270	0,4	636,00
	7415	ZV-100 LARGO DE 350	0,4	636,00	

Equipos de llenado circuitos solares Serie Solar

141	Pág Catálogo	Código	Modelo	P.V.P. Euros
		6516	KIT LLENADO SOLAR FIJO	720,00

Electrobombas in line de rotor seco para recirculación de agua Serie L

142	Pág. Catálogo	Código	Modelo	C.V.	P.V.P. Euros
		1500	L-50	0,5	1.517,00
		1502	L-50/2	0,5	1.599,00
		1501	L-65	0,5	1.538,00
		1503	L-70	1	1.579,00
		1504	L-70/2	1	1.599,00
		1505	L-85	2	1.763,00
		1506	L-85/2	2	1.845,00

Electrobombas circuladoras de rotor seco in-line Serie LRS

143	Pág. Catálogo	Código	Modelo	C.V.	P.V.P. Euros.
		SERIE LRS Y SERIE LRS-D			Consultar

Electrobombas de corriente continua a 24 V Serie SUB-CC/24V.

144	Pág. Catálogo	Código	Modelo	C.V.	P.V.P. Euros
		1215	SUB-CC/ 24 V.	0,5	812,00

Bombas de arrastre magnético Serie MAG

145	Pág. Catálogo	Código	Modelo	C.V.	P.V.P. Euros
		7380	MAG-13 M	0,13	626,00
		7381	MAG-15 M	0,20	1.076,00
		7382	MAG-17 M	0,17	1.327,00
		7384	MAG-33 M	0,33	1.333,00
		7385	MAG-33 T	0,33	1.312,00
		7386	MAG-75 M	0,75	1.710,00
		7387	MAG-75 T	0,75	1.644,00
		7388	MAG-150 M	1,5	2.706,00
		7389	MAG-150 T	1,5	2.702,00
		7392	MAG-200 M	2	2.841,00
		7393	MAG-200 T	2	2.825,00
	7390	MAG-300 T	3	4.859,00	
	7391	MAG-400 T	5,5	10.726,00	



hidráulica alsina, s.a.

Doctor Ferrán, 38-42 - 08120 La Llagosta (Barcelona)

Tel. 93 574 30 84 - Fax: 93 560 42 00

e-mail: comercial@bombashasa.com

export@bombashasa.com - sat@bombashasa.com

www.bombashasa.com



Distribuidor